

CLINICAL LABORATORY

Preparedness *and* Response Guide

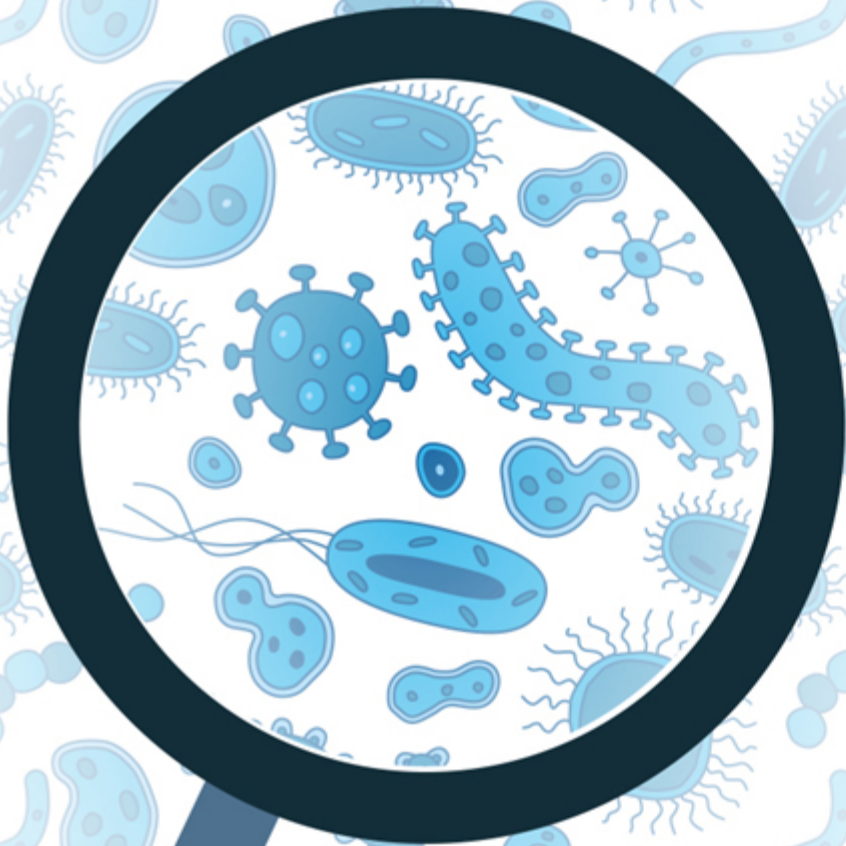

APHL ASSOCIATION OF
PUBLIC HEALTH LABORATORIES®



AMERICAN
SOCIETY FOR
MICROBIOLOGY

TABLE OF CONTENTS

Table of Contents	2
State Information.....	7
Introduction.....	10
Laboratory Response Network (LRN).....	15
Other Emergency Preparedness Response Information:	19
Radiological Threats	21
Food Safety Threats	25
BioWatch Program	27
Bio Detection Systems – BDS.....	28
Biosafety Basics	31
Biosafety Defined.....	31
Biosafety Levels	31
Laboratory Exposures and Lab Acquired Infections (LAIs)	34
Aerosol and Droplet Production	35
BSL-3 Practices and When to Use BSL-3 Practices in a BSL-2 Laboratory	37
Biological Risk Assessment.....	42
Risk Assessment: a 5-step Process Involving Hazard Identification and Hazard Control	44
Biosecurity Basics.....	46
Biosecurity Defined.....	46
Biosecurity and Select Agents.....	46
Risk Management	47
Example Guidance: A Biosecurity Risk Assessment and Management Process.....	47
Chain-of-Custody Guidance for Clinical Laboratories.....	54
Regulations That Impact Clinical Laboratories	56
Select Agent Regulations.....	56
APHIS/CDC Forms.....	56
What to do if you Suspect or Have a Confirmed Identification of a Select Agent.....	57
OSHA Bloodborne Pathogens Regulations	57
Clinical Laboratory Improvement Act (CLIA)	61
Agents.....	62

Quick Reference Guide to Specimen Collection of Suspected Agents of Bioterrorism & Emerging Infectious Diseases.....	63
Quick Reference Guide to Specimen Collection of Unknown Virus.....	69
Quick Reference Guide to Specimen Collection for Botulism.....	71
Quick Reference Guide to Specimen Collection for Staphylococcal Enterotoxin B.....	73
<i>Bacillus anthracis</i> (ANTHRAX).....	75
<i>Bacillus anthracis</i> Identification Flowchart.....	82
<i>Brucella</i> spp. (<i>B. abortus</i> , <i>B. canis</i> , <i>B. melitensis</i> , and <i>B. suis</i>) (BRUCELOSIS).....	85
<i>Brucella</i> Identification Flowchart.....	102
<i>Burkholderia mallei</i> (GLANDERS).....	108
<i>Burkholderia mallei</i> Identification Flowchart.....	115
<i>Burkholderia pseudomallei</i> (MELIOIDOSIS).....	118
<i>Burkholderia pseudomallei</i> Identification Flowchart.....	126
<i>Francisella tularensis</i> (TULAREMIA).....	129
<i>Francisella tularensis</i> Identification Flowchart.....	137
<i>Yersinia pestis</i> (PLAGUE).....	140
<i>Yersinia pestis</i> Identification Flowchart.....	152
AlphaViruses.....	156
Botulinum Toxin (BoNT) <i>Clostridium botulinum</i>	160
<i>Coxiella burnetii</i> (Q FEVER).....	164
Orthopox viruses (SMALLPOX).....	169
<i>Ricinus communis</i> (RICININE).....	173
Staphylococcal Enterotoxin B (SEB) <i>Staphylococcus aureus</i>	177
Viral Hemorrhagic Fevers (VHF).....	180
Packaging and Shipping.....	188
Introduction.....	190
Regulatory Overview.....	190
Required Trainings.....	198
Transport.....	203
Diagram 1. IATA and U.S. Postal Service Classification Flowchart Guidance.....	205
Diagram 2. DOT Classification Flowchart Guidance.....	206
Table 2. IATA and DOT Indicative Category A List.....	208



Table 3. Packing Requirements for Exempt Human Specimens, Category B Substances, and Category A Substances	211
Diagram 3. Exempt Human Specimen and Exempt Animal Specimen Packaging Example	215
Diagram 4. Exempt Specimen Outer Package Example	216
Diagram 5. Exempt Specimen with Dry Ice Outer Package Example	216
Diagram 6. Exempt Human Specimen Label Example.....	217
Diagram 7. Biological Substance, Category B Packaging Example.....	218
Diagram 8. Biological Substance, Category B Label Example	218
Diagram 9. Biohazard Label Example for Inner Secondary Container	219
Diagram 10. Biological Substance, Category B with Dry Ice Outer Package Example.....	219
Diagram 11. Category A Infectious Substance Outer Packaging Example.....	221
Diagram 12. Category A Infectious Substance with Dry Ice Outer Packaging Example	222
Diagram 13. Category A, Infectious Substance Class 6 Hazard Label Example.....	222
Diagram 14. Category A Label Change Notice	223
Diagram 15. Biohazard Label	223
Diagram 16. UN Certification Markings	224
Diagram 17. Dry Ice Label Change Notice.....	226
Diagram 18. Dry Ice Label Example	227
Diagram 19. Overpack Label Example	227
Shipper's Declaration for Dangerous Goods Overview	230
Diagram 20. FedEx Shipper's Declaration for Dangerous Goods Form Example	231
Transfers and Permits.....	237
Guidance.....	239
Supplies.....	242
Diagram 21. UN Symbol Marking Example	244
Table 4. Category A Supplies Table.....	245
Table 5. Category B Supplies Table	246
Table 6. Overpack Supplies Table.....	246
Table 7. Dry Ice B Supplies Table.....	246
Table 8. Summary Table.....	248
WHO A Guide for Shippers of Infectious Substances, 2015-2016	249
Checklist 1. Category A Guidance Checklist	250



Checklist 2. Shipper’s Declaration Guidance Checklist	252
Checklist 3. FedEx Shipper’s Declaration Checklist	254
Checklist 4. FedEx Shipper’s Declaration Verification Checklist	256
Checklist 5. Category B Guidance Checklist.....	258
Checklist 6. Dry Ice Guidance Checklist.....	260
Checklist 7. Overpack Guidance Checklist.....	262
Checklist 8. Exempt Specimen Guidance Checklist	263
Category A List vs. Select Agent List Comparison job aid.....	265
Appendix	268
<i>Bacillus anthracis</i> Characteristics Chart	269
<i>Brucella</i> spp. Identification Flowchart	271
<i>Brucella</i> spp. Characteristics Chart	272
<i>Burkholderia mallei</i> Identification Flowchart.....	273
<i>Burkholderia mallei</i> Characteristics Chart	274
<i>Burkholderia pseudomallei</i> Identification Flowchart.....	275
<i>Burkholderia pseudomallei</i> Characteristics Chart	276
<i>Francisella tularensis</i> Presumptive ID Chart	277
<i>Francisella tularensis</i> Identification Flowchart.....	278
<i>Francisella tularensis</i> Characteristics Chart	279
<i>Yersinia pestis</i> Identification Flowchart	280
<i>Yersinia pestis</i> Characteristics Chart.....	281
<i>Yersinia pestis</i> Differentiation Chart.....	282
Decontamination of Select Agents Isolated in the Clinical Laboratory	283
APHIS/CDC Select Agent Form 2 Checklist.....	284
APHIS/CDC Select Agent Form 3 Checklist.....	286
APHIS/CDC Select Agent Form 4 Checklist.....	289
Select Agent Algorithm Guide	292
What to Do When a Select Agent is Suspected in Your Lab.....	293
OSHA Poster 2015.....	294
Category A vs. Select Agent List Comparison	295
NLTN Biosafety Checklist for Clinical Laboratories* Biosafety Level 2.....	298
NLTN Biosafety Checklist for Clinical Laboratories* Biosafety Level 3.....	308



Job Hazard Analysis Chart Job Aid	321
Job Hazard Analysis Examples Job Aid	322
APHL ID Biosafety Checklist 2015	323
Transporting Infectious Substances Safely.....	324
Sentinel Laboratory Biochemical Reference Chart.....	325
Tests to Differentiate Organisms Similar to the Bioterrorism Agents.....	327
Acknowledgements.....	331

Publication Date and Revisions

Content approval date: 08/01/2016

Version 1.0: Document publication date: 11/03/2016

Version 1.1: Revision date: 11/16/2016 (minor updates to various URLs throughout the document)

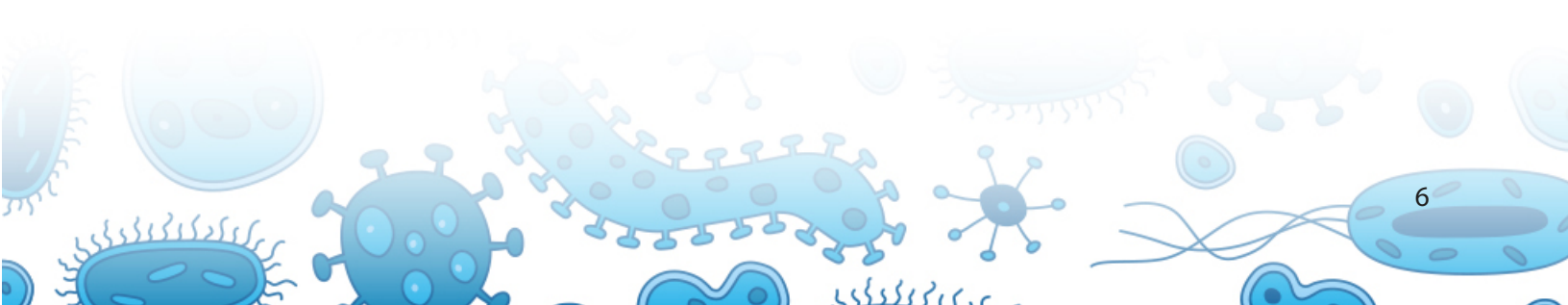

STATE INFORMATION

Public Health Laboratory/LRN Reference Laboratory Name:

Address: _____

Phone number: _____

Website (optional): _____

GPS (optional): _____

EMERGENCY NUMBERS

Laboratory (business hours): _____

Laboratory (after hours): _____

Epidemiologist (on call or 24/7): _____

Biothreat Number/Coordinator: _____

Chemical Threat Number/Coordinator: _____

OTHER AGENCIES, EMERGENCY NUMBERS

Local Law Enforcement: 911, If not 911, _____

FBI, report threats or crimes: <http://www.fbi.gov/report-threats-and-crime>

Local FBI Field Office (optional): _____

State/Local Hazmat: _____

State Highway Patrol: _____

State Poison Control Center: _____

STATE PUBLIC HEALTH LABORATORY: CONTACT INFORMATION

General Microbiology: _____

General Virology/Serology: _____

Molecular Biology: _____

Specimen Receiving/Mailroom: _____

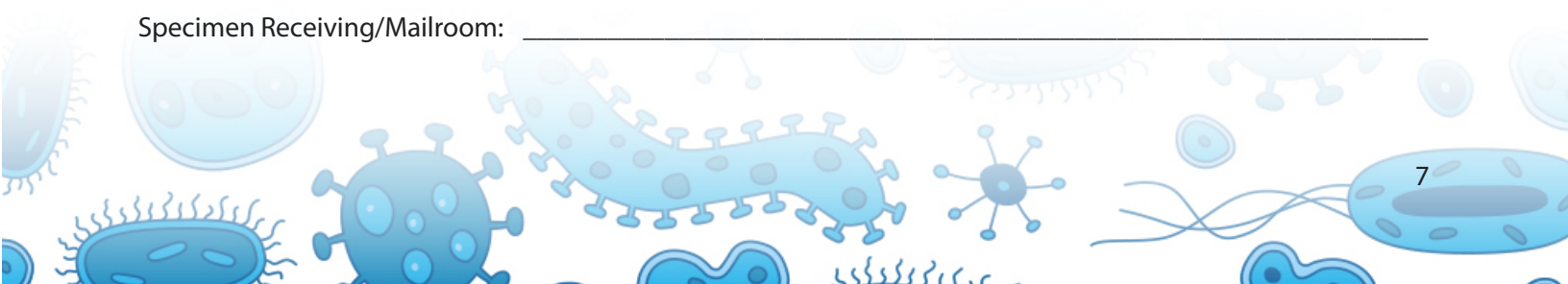

Environmental Chemistry _____

State Specimen Courier: _____

(Other state lab sections): _____

Links to County/Local/City Laboratories: _____

ADDITIONAL STATE PUBLIC HEALTH LABORATORY INFORMATION

Laboratory Submission Forms: (*website*) _____

Pack and Ship Information: (*website*) _____

Training Information: (*website*) _____

Health Alert Network (HAN): (*website/email/phone*) _____

OTHER STATE PUBLIC HEALTH AGENCIES:

Epidemiology: (*website*) _____

Reportable Diseases: (*website*) _____

Public Health: (*website*) _____

FEDERAL PUBLIC HEALTH AGENCIES, INFORMATION

CDC Information: 1-800-CDC-Info 800-232-4636

Select Agent Program information: <http://www.selectagents.gov/>

USDA APHIS: <http://www.aphis.usda.gov/wps/portal/aphis/home/>

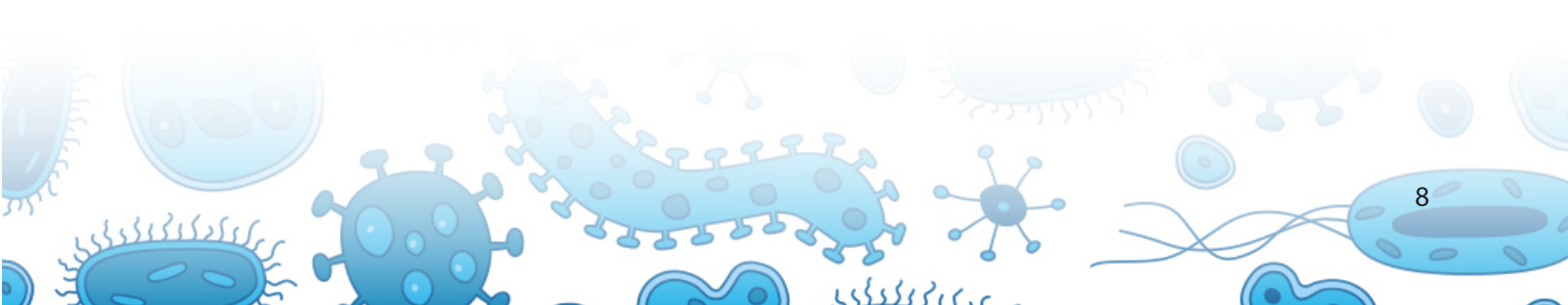

INTRODUCTION

Bioterrorism is defined as the “intentional use of microorganisms, or toxins derived from living organisms, to produce death or disease in humans, animals or plants”. A bioterrorist event may be either announced (overt) or unannounced (covert). An announced (overt) event would include a notification that an agent has been released, leading law enforcement and public health to be involved from the beginning. An unannounced (covert) event might not be noticed until days or weeks after the event, once the initial incubation period is complete. Hospitals would probably be the first to receive patients exhibiting symptoms and initially the illness may be perceived as an unusual disease cluster.

DATE APPROVED:

8 /1/ 2016

Hospital and clinical laboratories are the first line of defense against biothreat agent infections and emerging infectious diseases. These laboratories will likely be the first to see clinical specimens from patients who have been exposed to intentional biothreat agent releases, naturally occurring biothreat agents or emerging infectious diseases. Their quick recognition and communication of these suspect agents is the key to rapid identification and response.

This guide was developed to assist laboratories by providing guidance on the responsibilities and practices that are recommended when dealing with biothreat agents. In it you will find the tools and standards necessary to recognize if your laboratory has received a patient specimen containing a biothreat agent and how to handle it. This guide also covers basic laboratory biosafety, packaging and shipping, regulations that impact LRN Sentinel Laboratories and much more.

USING THIS GUIDE

This manual should not take the place of your standard operating procedures. It is intended as a tool to assist the clinician or laboratorian with recognizing biothreat agent characteristics. It also acts as a reference on the standards for testing for these agents and procedures on how to follow up with your State and Federal partners if those tests indicate a suspect biothreat agent.

It is recommended that this guide be stored near the laboratory where it can be readily accessible to the appropriate laboratory staff. Any laboratorian who will be involved in the analysis of a suspected biothreat agent should be trained in the identification and referral procedures and packaging and shipping requirements.



SENTINEL LABORATORY DEFINITION

LRN sentinel laboratories consist of any laboratory capable of analyzing or referring specimens or samples that may contain microbial agents, biological toxins, chemical agents or their metabolites, or radiological agents. This includes environmental, food, veterinary, agriculture, military, public health, as well as clinical laboratories who may, through routine activities, encounter samples that contain these types of dangerous agents from specimens. In addition to recognizing threat agents, sentinel laboratories work closely with public health to monitor diseases reportable by state law and to assist in the surveillance of endemic or emerging pathogens and pandemics.

Laboratories that do not meet the sentinel criteria but believe they may have encountered a biothreat agent should contact their local LRN Reference Laboratory or County Health Department for assistance.

- Think safety first. Sentinel laboratories are only required to use the appropriate methods for ruling out biothreat agents. If this is not possible, laboratories should not attempt to identify the organism. Remember trigger points.
- Contact your LRN Reference Laboratory or Public Health Agency to determine if patient samples should be sent.
- Have at least two members of your staff trained in how to safely and correctly package and ship Category A and Category B infectious agents.

SENTINEL CLINICAL LABORATORY DEFINITION

The laboratory is certified to perform high complexity testing under the Clinical Laboratory Improvement Amendments of 1988 (CLIA) by the Centers for Medicare & Medicaid Services (CMS) for the applicable Microbiology specialty or the laboratory is a Department of Defense (DoD) Laboratory certified under the DoD Clinical Laboratory Improvement Program or the laboratory is a veterinary medical diagnostic laboratory that is fully accredited by the American Association of Veterinary Laboratory Diagnosticians (AAVLD). Laboratory in-house testing includes Gram stains and at least one of the following: lower respiratory tract, wound or blood cultures.

Note: If your laboratory does not meet the definition above, please refer to items 1, 2, and 3 in the Responsibilities of the Sentinel Clinical Laboratory section below.



RESPONSIBILITIES OF THE SENTINEL CLINICAL LABORATORY

1. The laboratory is familiar with reportable disease guidelines in its jurisdiction, and has policies and procedures in place to refer diagnostic specimens or isolates suspected to contain agents of public health significance to the local or state public health laboratory in its jurisdiction.
2. The laboratory ensures personnel have met the applicable federal regulations for packing and shipping of infectious substances.
3. The laboratory has policies and procedures for referral of suspect biothreat agent specimens and/ or isolates to the LRN Reference Laboratory in its jurisdiction that reflect the American Society for Microbiology (ASM) Sentinel Level Clinical Microbiology Laboratory Guidelines for Suspected Agents of Bioterrorism and Emerging Infectious Diseases available for download on the ASM website at <http://www.asm.org/index.php/science-skills-in-the-lab/sentinel-guidelines>
4. The laboratory maintains the capability to perform testing outlined in the ASM Sentinel Level Clinical Microbiology Laboratory Guidelines for Suspected Agents of Bioterrorism and Emerging Infectious Diseases and demonstrates annual competency by participation in proficiency testing or exercises, such as the Laboratory Preparedness Exercise or state-developed challenge sets.
5. The laboratory has a Class II or higher Certified Biological Safety Cabinet (BSC).
6. The laboratory complies with Biosafety Level II (BSL-2) practices as outlined in the current edition of the Biosafety in Microbiological and Biomedical Laboratories guidelines.
7. The laboratory complies with applicable Occupational Safety and Health Administration (OSHA) regulations for a respiratory protection program.
8. The laboratory complies with Select Agent Program rules and regulations of the [Select Agent Program](#).

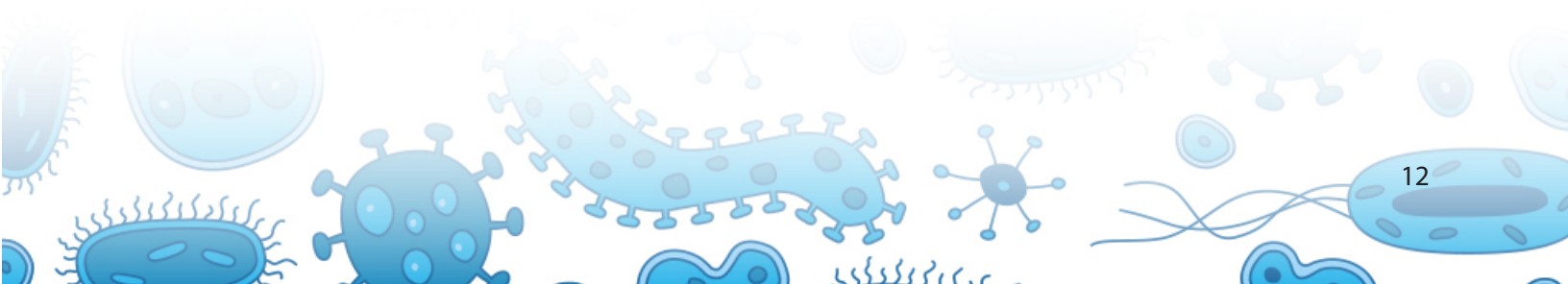

RESPONSIBILITIES OF THE LRN REFERENCE PUBLIC HEALTH LABORATORY

For the sentinel clinical laboratories that meet the above definition, the appropriate LRN Reference Public Health Laboratory will:

1. Maintain a sentinel clinical laboratory database that includes the elements identified below:
 - a. Required List of Common Database Elements
 - i. Laboratory CLIA number
 - ii. Laboratory name
 - iii. Laboratory mailing address
 - iv. Laboratory physical address
 - v. Primary contact information (Name, Title, Email, Phone, Fax)
 - vi. Secondary contact information (Name, Title, Email, Phone, Fax)
 - vii. 24/7 Emergency contact (Phone/Pager/Answering service)
 - viii. List of each method for receiving emergency alerts and communications (e.g., Email, Fax, Phone)
 - b. Recommended List of Common Database Elements
 - i. Biosafety precautions:
 1. Highest Biosafety Level (BSL-2, BSL-3, Other/Don't Know).
 2. Class II Biological Safety Cabinet (Yes, No).
 3. Number of Class II Biosafety Cabinets.
 4. Additional Respiratory Protection Information such as N-95 or P-100 fit testing.
 - ii. Personnel Information:
 1. How many personnel are currently competent to package and ship infectious substances?
 2. How many personnel are trained to perform high complexity Microbiology testing?
 3. Of these, how many personnel are trained to perform rule-out or refer testing for a suspect biothreat agent as described in the *ASM Sentinel Level Clinical Microbiology Laboratory Guidelines for Suspected Agents of Bioterrorism and Emerging Infectious Diseases*?
 4. Participation in a Competency Assessment (CAP/LPX, State Issued Microbiology Challenge Sets, Other).
 5. Testing Capabilities (e.g., Molecular Biology, Sequencing, Mycobacteriology, Virology).
2. Provide training or assures access to training for sentinel clinical laboratories encouraging them to maintain competent staff knowledgeable in the *ASM Sentinel Level Clinical Microbiology Laboratory Guidelines for Suspected Agents of Bioterrorism and Emerging Infectious Diseases*. Training must encompass the following subjects: Recognition, Rule-out testing and Referral of potential biothreat agents, packaging and shipping of infectious specimens and isolates following applicable federal regulations, chain of custody, and biosafety and risk assessment.

3. Utilize real events or develops and implements exercises to assess the functionality of the public health laboratory system, such as the ability of sentinel clinical laboratories in their jurisdiction to correctly refer samples to the local or state public health laboratory.
4. Provide or ensure 24/7 availability to the sentinel clinical laboratories for information and technical consultations and necessary confirmatory testing.
5. Ensure a robust electronic system for communication of routine and emergency alerts and critical information to all of the sentinel clinical laboratories within the jurisdiction.

SENTINEL LAB DEFINITION

http://www.asm.org/images/PSAB/Sentinel-Clinical-Laboratory-Definition_2013.pdf

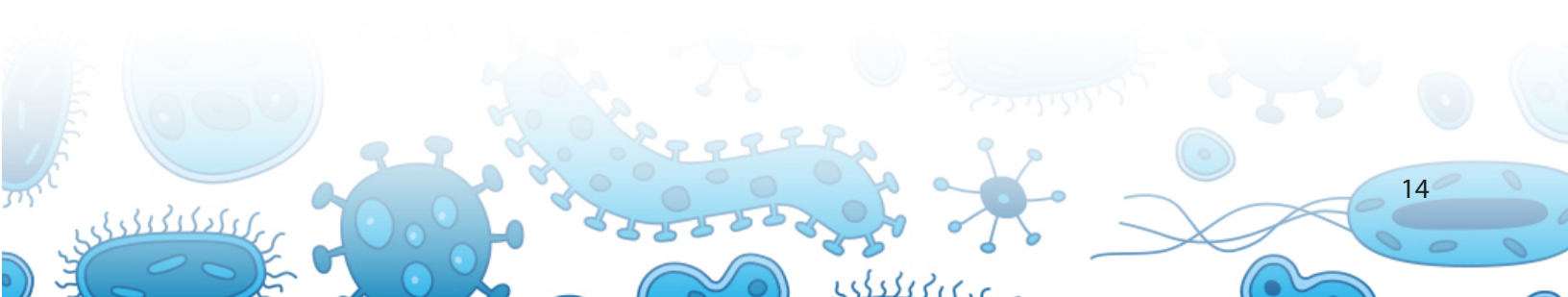

LABORATORY RESPONSE NETWORK (LRN)

The Laboratory Response Network (LRN) was launched by the Department of Health and Human Services (HHS), Centers for Disease Control and Prevention (CDC) in 1999. The LRN is a vast international network comprised of local, state and federal public health laboratories, international laboratories, as well as food testing, veterinary diagnostic, and environmental testing laboratories that provide the laboratory infrastructure and capacity to respond to biological and chemical terrorism, and other public health emergencies. The LRN is also a partnership between key stakeholders in the preparation and response to biological and chemical terrorism. The CDC, the Federal Bureau of Investigation (FBI), and the Association of Public Health Laboratories (APHL) were key partners in establishing the LRN. The CDC is currently overseeing the LRN program.



LABORATORY NETWORK FOR BIOLOGICAL TERRORISM (LRN-B)

LRN bioterrorism preparedness and response activities emphasize local laboratory response by helping to increase the number of trained laboratory workers in state and local public health facilities; distributing standardized test methods and reagents to local labs; promoting the acquisition of advanced technologies; and supporting facility improvements.

There are currently more than 150 member laboratories on the biological side of the LRN. Although the majority of current members are public health laboratories, there are also military, international, veterinary, agriculture, food, and water testing laboratories, representing all 50 states, Australia, Canada, the United Kingdom, Mexico and South Korea. The LRN continues to add new member laboratories for biological agent detection.

One of the LRN's goals is to expand membership to broaden the scope of biological agent detection, particularly among veterinary diagnostic, food and water testing, private, and commercial laboratories.

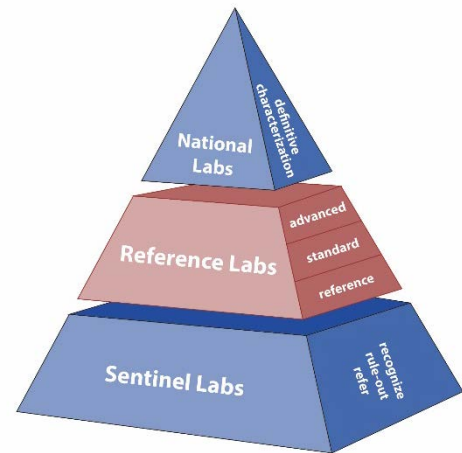

SENTINEL LABORATORIES

LRN sentinel laboratories play a key role in the early detection of biological agents. Sentinel laboratories provide routine diagnostic services, rule-out, and referral steps in the identification process. While these laboratories may not be equipped or authorized to perform the same tests as LRN reference laboratories, they can test samples.

There are an estimated 25,000 private and commercial laboratories in the United States, some of which can provide critical sentinel laboratory capacity. The majority of these laboratories are hospital-based, clinical institutions, and commercial diagnostic laboratories. The LRN is currently working with the American Society for Microbiology and state public health laboratory directors to ensure that these private and commercial laboratories are part of the LRN.

While most of these laboratories do not have the facilities or the technology to perform confirmatory testing, they represent the first contact with patients and are in a position to alert public health officials. They can also conduct tests to rule out other diseases and ship samples to appropriate reference laboratories.

REFERENCE LABORATORIES

LRN reference laboratories are responsible for investigating, testing and/or referring suspect specimens. Inclusion as a reference testing facility for biological agent detection is not automatic and prospective members must demonstrate certain capabilities and capacities, and meet established agent-specific performance standards. For both biological and chemical laboratory membership, the state public health laboratory director has a key role in determining whether additional laboratory capacity is critical to the state's overall emergency response goals. If needed, additional laboratories may be invited to participate by a state laboratory director.

NATIONAL LABORATORIES

LRN national laboratories, including those operated by CDC, U.S. Army Medical Research Institute for Infectious Diseases (USAMRIID), and the Naval Medical Research Center (NMRC), are responsible for specialized strain characterizations, bioforensics, select agent activity, and handling highly infectious biological agents.

<http://www.emergency.cdc.gov/lrn/biological.asp>

LABORATORY RESPONSE NETWORK FOR CHEMICAL THREATS (LRN-C)

The chemical preparedness side of the LRN (LRN-C) employs a more centralized structure. This means initial testing in a suspected chemical event will occur at CDC. Using sophisticated and unique high-throughput analysis capabilities, such as mass spectrometry, CDC laboratories perform tests on the first 40 clinical specimens to measure human exposure. Results of these tests are reported to affected states, and if needed, appropriate LRN members may be asked to test additional samples. This approach is necessary because the analytical expertise and technology resources required to respond to a chemical event is substantially high.

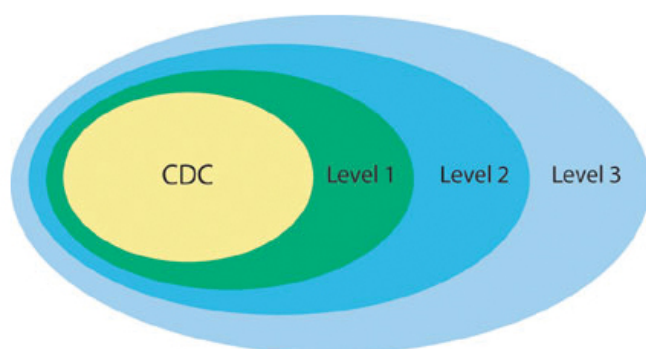

CDC funding supports 62 U.S. states, territories, and metropolitan areas through the Public Health Emergency Preparedness cooperative agreement. In 2010, fifty-three laboratories within these jurisdictions provided emergency response capabilities for their local areas, the nation, or both. These laboratories make up the chemical component of the Laboratory Response Network (LRN).

CDC has assisted LRN-C members with purchasing instruments needed for measuring chemicals in blood and urine specimens. Because of the complexity of the instrumentation, on-site operation training is provided by the instrument vendor as part of the purchase package. Through hands-on training at CDC and computer-

based training, CDC trains Level 1 and Level 2 labs on analytical methods. Network members that receive methods and instrumentation must also participate in a rigorous quality assurance program to ensure that network labs provide precise, accurate, high-quality data. CDC also provides a “train-the-trainer” course that will give chemical terrorism coordinators the tools they need to train partners in their jurisdictions, such as hospital staff, about sample collection and shipping.

A designation of Level 1, 2, or 3 identifies laboratory capabilities and defines member network participation. (Please note that the level designations changed in early 2005 so that laboratories previously designated “Level 1” are now “Level 3,” and laboratories previously designated “Level 3” are now “Level 1.”)

LEVEL 3 LABORATORIES

Nine laboratories are designated as Level 3 laboratories. All 53 laboratories have Level 3 capacity. These laboratories work with hospitals and other first responders within their jurisdiction to maintain competency in clinical specimen collection, storage, and shipment.

LEVEL 2 LABORATORIES

Thirty-four labs are designated as Level 2 laboratories. Chemists in these laboratories are trained to detect exposure to a number of toxic chemical agents. Analysis of cyanide, nerve agents, and toxic metals in human samples are examples of Level 2 activities.

LEVEL 1 LABORATORIES

Ten laboratories currently participate in Level 1 activities. These laboratories, which serve as surge-capacity laboratories for the CDC, are able to detect the toxic chemical agents that Level 2 laboratories can detect plus exposure to an expanded number of chemicals, including mustard agents, nerve agents, and other toxic industrial chemicals. Using unique high-throughput analysis capabilities, they expand CDC’s ability to analyze large number of patient samples when responding to large-scale exposure incidents.

<http://www.emergency.cdc.gov/lrn/chemical.asp>

CONTACTING THE LABORATORY RESPONSE NETWORK (LRN)

NOTE: If you believe that you have been exposed to a biological or chemical agent, or if you believe an intentional biological threat will occur or is occurring, please contact your local health department and/or your local police or other law enforcement agency.

Local public health laboratories, private laboratories, and commercial laboratories with questions about the LRN should contact their state public health laboratory director or the Association of Public Health Laboratories.

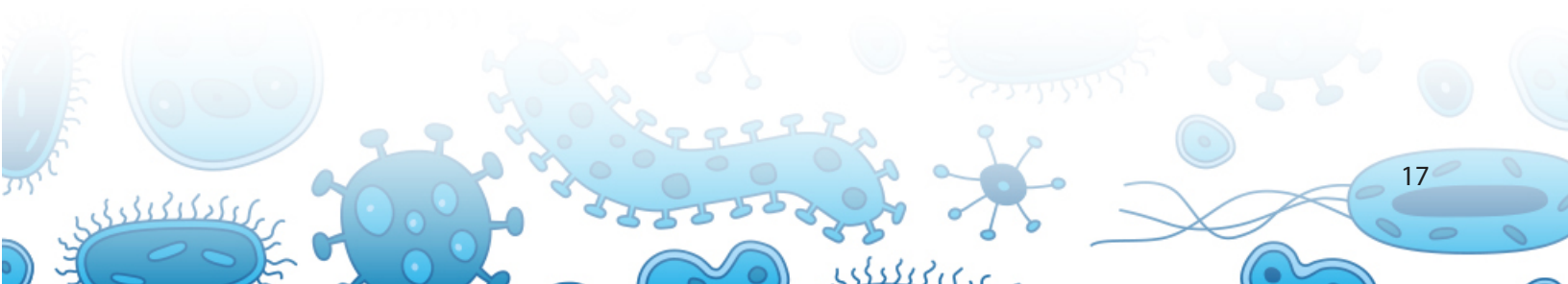

ROLE OF EPIDEMIOLOGISTS

Epidemiology is the science that studies the patterns, causes, and effects of health and disease conditions for defined populations. Considered one of the cornerstones of public health, epidemiologists work closely with reference laboratories along with a wide variety of other members of the public health team to perform surveillance, detect outbreaks, implement control & preventive measures, and communicate findings and recommendations. To accomplish this, epidemiologists collect data on reportable disease-causing organisms and symptoms meeting case definitions to detect outbreaks by interviewing patients or their families, gather patient demographics, note the signs and symptoms of the disease, develop a timeline of the exposure history and laboratory results.

The knowledge that epidemiology brings to the table helps to identify health risk factors, prevention strategies, community needs, works to target prevention and informs health policy decisions on local, national and global levels. This information can be used to prevent future adverse health events from occurring with the appropriate government and community support.

Each state has a list of diseases that are reportable. Make sure that you are aware of the laws in your state, as well as who to contact in the event you suspect one of these diseases. Additionally, active surveillance can help identify trends that might indicate an outbreak. Sharing information between the laboratory and the proper county and state officials is vital in protecting the public's health.

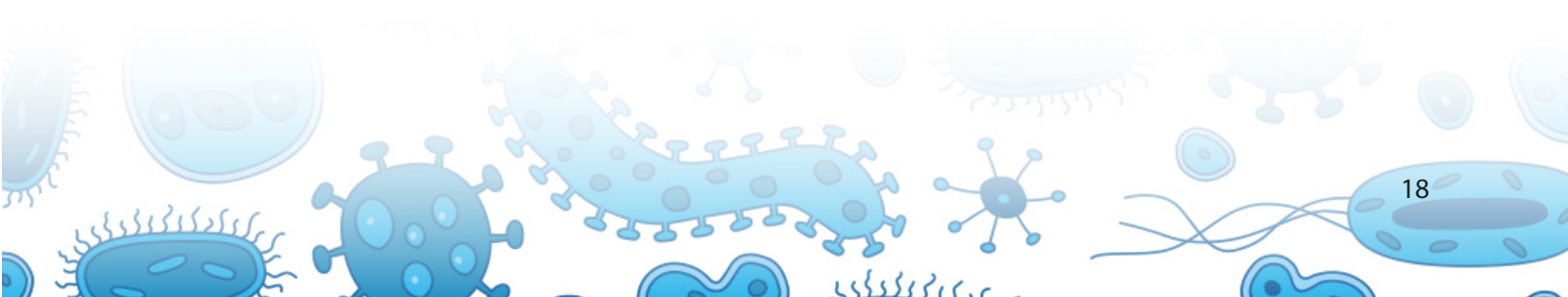

OTHER EMERGENCY PREPAREDNESS RESPONSE INFORMATION:

CHEMICAL THREATS

Chemical agents can be poisonous vapors, aerosols, liquids or solids that can have toxic effects on people, animals, or plants. These chemicals can be naturally occurring in the environment or synthetically produced. Chemical releases can be unintentional, as in the case of an industrial accident, or intentional, as in the case of a terrorist attack. Early detection and accurate identification are critical to enable effective treatment and to prevent additional exposures of chemical threats.

Some chemical agents are odorless and tasteless. Their effects can be immediate (a few seconds to a few minutes) or delayed (2 to 48 hours). While some agents are lethal, they are difficult to deliver in lethal concentrations due to either production issues or the fact that they dissipate rapidly.

A chemical attack could come without warning. The presence of many dead insects or birds may indicate a chemical agent release. Signs of a human exposure may include difficulty breathing; eye irritation; loss of coordination; nausea; or a burning sensation in the nose, throat, and lungs.

The LRN-C is activated when a suspected terrorist incident or significant chemical exposure event has occurred. CDC may advise medical facilities to collect blood and/or urine specimens from affected patients in accordance with the appropriate specimen collection and shipping protocols:

http://emergency.cdc.gov/labissues/pdf/Flowchart_ChemEvent_Specimen_collection.pdf.

CHEMICAL EMERGENCY RESPONSE TEAM

CDC's Division of Laboratory Sciences (DLS) and National Biomonitoring Program (NBP) provide effective laboratory support for the public health response to chemical threat agents and threats involving selected toxins.





The CDC maintains 24-7 laboratory response capability and can deploy the Chemical Emergency Response Team within two hours of a request to assist with specimen collection, packaging, storage, and shipment. DLS scientists work with state and local officials to collect samples and transport them to CDC where testing can be done to assess people's exposure to chemical agents.

RAPID TOXIC SCREEN

The CDC laboratory developed and performs the Rapid Toxic Screen (RTS), a series of tests that analyzes 150 chemical agents in people's blood and urine. Results of the Rapid Toxic Screen help identify those exposed, to what chemical(s) they were exposed, and how much of a particular chemical their bodies absorbed. This information is critical to medical and public health personnel managing a chemical public health emergency.

List of lab resources related specifically to chemical emergencies:

- [Flowchart: Chemical Exposure Event Specimen Collection](#)  (770 KB, 1 page)
This is a one-page document containing directions and visual representations for use in collecting blood and urine specimens from potentially exposed individuals.

- [MMWR: Public Health Contacts for Lab Testing To Confirm Exposure During a Potential or Known Chemical Terrorism Event](#)
MMWR 14 Jan 2005; 54 (RR01):25.
- [Chemical Agents: Shipping Instructions for Specimens Collected From People Who May Have Been Exposed to Chemical Agents](#)
Centers for Disease Control and Prevention Shipping Instructions for Specimens Collected from People Who May Have Been Exposed to Chemical-Terrorism Agents"
- [Chemical Agents: Instructions for Shipping Blood Specimens to CDC after a Chemical Event](#)  (2.05 MB, 1 page)
This is a one-page document containing photographs, and related text, of the required steps necessary for packaging and shipping blood specimens to CDC.
- [Chemical Agents: Chemical Exposure Blood Specimen Collection and Shipping Manifest](#)  (69 KB, 2 pages)
- [Chemical Agents: Instructions for Shipping Urine Specimens to CDC after a Chemical Event](#)  (5 MB/1 page)
This is a one-page document containing photographs, and related text, of the required steps necessary for packaging and shipping urine specimens to CDC.
- [Chemical Agents: Chemical Exposure Urine Specimen Collection and Shipping Manifest](#)  (15 KB, 2 pages)
- [CDC's Lab Response to Suspicious Substances](#)
Explains how federal, state, & local agencies respond to threatening letters & how labs play a role in detection & response.
- [CDC Laboratory Response Network \(LRN\) website](#)
Overview of the LRN, an integrated network of state & local public health, federal, military, & international labs that can respond to both bioterrorism & chemical terrorism.

RELATED LINKS

- [American Association of Poison Control Centers](#)
- [American College of Medical Toxicology](#)
- [American Academy of Clinical Toxicology](#)
- [ATSDR Medical Management Guidelines](#)
- [ATSDR ToxFAQs](#)
- [ATSDR Toxicological Profiles](#)
- [CDC Fourth National Report on Human Exposure to Environmental Chemicals](#)
- [Chemical Emergencies](#)
- [EPA Emergency Management](#)
- [Disaster Surveillance Forms](#)
- [NIOSH Chemical Safety](#)

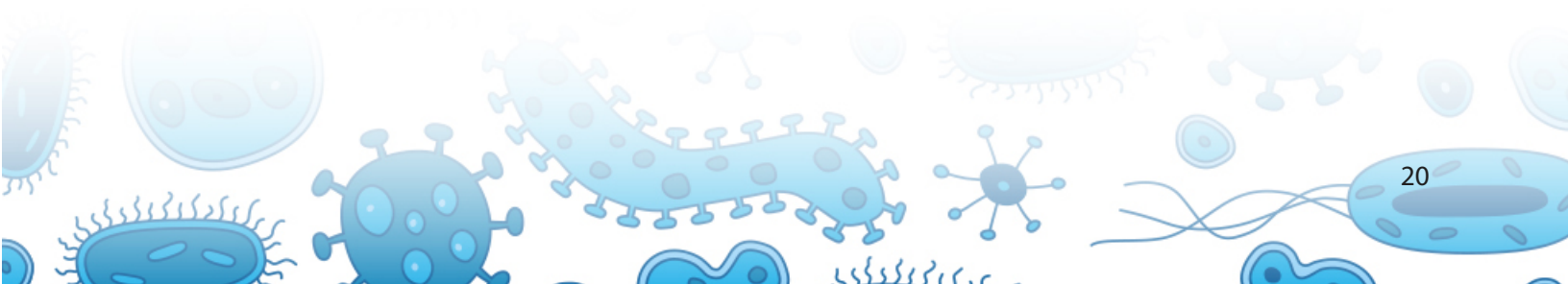

RADIOLOGICAL THREATS

Radiation emergencies may be intentional (e.g., caused by terrorists) or unintentional. Examples of different types of radiation emergencies include nuclear emergencies that include a nuclear weapon or improvised nuclear device (IND), dirty bombs or radiological dispersion devices (RDD), radiological exposure devices (RED), nuclear power plant, transportation or occupational accidents.

A critical part of a radiological emergency response is determining the number of potentially exposed persons who need medical treatment and the type of medical treatment they require.

Handheld radiation detectors (e.g., Geiger counters) are useful for measuring external contamination (outside the body) and identifying potentially exposed persons. However, the decision to provide medical treatment—and the type of medical treatment—requires quick and accurate identification of internal (i.e., inside the body) contamination.

CDC's Division of Laboratory Sciences (DLS) utilizes the Urine Radionuclide Screen (URS) to identify exposed persons and determine the level of exposure. URS is unique because it:

- Uses a small amount of urine from a single collection
- Maintains a steady workflow that consists of hundreds or thousands of samples, depending on the radionuclides being analyzed
- Provides results within 24 hours for the first 100 samples
- Identifies and quantifies radionuclides of public health concern

These capabilities are not available anywhere else in the federal government.

HHS has developed a new online diagnostic and treatment [toolkit](#) designed for health care providers, primarily physicians, who may have to provide medical care during a radiation incident. This downloadable toolkit includes easy-to-follow procedures for diagnosis and management of radiation contamination and exposure, guidance for the use of radiation medical countermeasures, and a variety of other features to facilitate medical responses.

LINKS

Centers for Disease Control and Prevention Radiation Emergencies <http://emergency.cdc.gov/radiation/>

Radiation Emergency Medical Management <http://www.remm.nlm.gov>

Environmental Protection Agency Radiation Protection: Emergency Preparedness and Response Programs <http://www.epa.gov/rpdweb00/emergency-response-overview.html>

Food and Drug Administration Radiation Emergencies <http://www.fda.gov/Drugs/EmergencyPreparedness/%20Bioterrorism%20and%20DrugPreparedness/ucm063807.htm>



OTHER LINKS:

INFORMATION ON MACHINES USING OR EMITTING RADIATION

[American Society for Therapeutic Radiology and Oncology](#) — An organization of physicians and scientists designed to disseminate the results of scientific research, promote excellence in patient care and provide opportunities for educational and professional development.

[Code of Federal Regulations \(CFR\)](#) — Title 21, Part 1020 CFR, which contains regulations for the manufacture of radiation machines, can be found here along with other CFR Titles.

[FDA - Whole-Body Computed Tomography \(CT\) Screening](#) — Contains the U.S. Food & Drug Administration's statements on the use of CT as a preventive or proactive healthcare measure for healthy individuals who have no symptoms or suspicion of disease. The site also discusses how FDA regulates CT, how a CT machine works, and the radiation risks of CT.

[FDA's Radiation-Emitting Products](#) — The Center for Devices and Radiological Health (CDRH) is the part of the U. S. Food & Drug Administration (FDA) that regulates the manufacture of radiation-emitting devices like x-ray machines.

[Mammography Quality Information](#) — This FDA site contains the federal Mammography Quality Standards Act (MQSA) rules, a small business guide to implementing the rules, and GAO reports on the effectiveness of the MQSA program.

[NVLAP Certified Dosimetry Vendors](#) — This is a list of labs who are accredited to process personnel dosimeters used to monitor exposure to ionizing radiation.

RADIOACTIVE MATERIAL INFORMATION

[Code of Federal Regulations \(CFR\)](#) — Title 49 CFR, which contains regulations for transporting hazardous material, can be found here along with other CFR Titles. This site is maintained by the National Archives and Records Administration.

[Conference of Radiation Control Program Directors \(CRCPD\)](#) — A nonprofit organization of state and local government employees who regulate the use of radiation. CRCPD's mission is "to promote consistency in addressing and resolving radiation protection issues, to encourage high standards of quality in radiation protection programs, and to provide leadership in radiation safety and education."

[NRC Generic Communications](#) — Contains NRC Information Notices, Generic Letters, Circulars, Bulletins and Administrative Letters.

[NRC Office of Federal and State Materials and Environmental Management Programs](#) — Information about NRC activities that directly impact states; results of state program audits.

[U.S. Nuclear Regulatory Commission \(NRC\)](#) — NRC's home page.

RADIOLOGIC TECHNOLOGY INFORMATION

[American Registry Of Radiologic Technologists](#) — The ARRT was founded in 1922 for the purpose of recognizing (certifying) individuals qualified in the safe and effective application of x-rays for medical purposes. Over the years the scope of ARRT's certification activities has expanded, but the fundamental purpose remains the identification of individuals qualified to practice in the profession of radiologic technology.

[American Society Of Radiologic Technologists](#) — The American Society of Radiologic Technologists is the oldest and largest national professional association for technologists in the radiologic sciences.

[Continuing Education \(CE\) Providers](#) — A list of CE providers offering courses approved by the Florida Department of Health, Bureau of Radiation Control, Radiologic Technology Program for renewal of Florida radiologic technologist certification.

[Nuclear Medicine Technologist Certification Board](#) — NMTCB was founded in 1977 to establish and maintain a voluntary program for certification of nuclear medicine technologists by nuclear medicine technologists.

[Radiological Society North America](#) — The mission of the RSNA is to promote and develop the highest standards of radiology and related sciences through education and research.

[Society Of Nuclear Medicine](#) — SNM is an international scientific and professional organization founded in 1954 to promote the science, technology and practical application of nuclear medicine. Membership consists of 16,000 physicians, technologists and scientists specializing in the research and practice of nuclear medicine.

[CDC's Radiation Emergency Page](#) — The U.S. Centers for Disease Control and Prevention (CDC) would play a key role in protecting the public health during and after an emergency involving radiation or radioactive materials. To help people prepare for a radiation emergency, CDC has collected a wealth of information for first responders, health care providers, and the public.

[Facts about Diethylenetriaminepentaacetate DTPA \(CDC\)](#) — Diethylenetriaminepentaacetate (DTPA) can remove certain radioactive materials from the human body, but it must be taken under the guidance of the Radiation Emergency Assistance Center/Training Site (REAC/TS) of the Oak Ridge Institute.

[Facts about Neupogen \(CDC\)](#) — Neupogen is a drug that was approved for use by the FDA in 1991 for cancer patients with bone marrow damage due to chemotherapy or radiotherapy. It may also be useful for patients who have bone marrow damage from accidental exposures to high doses of radiation, and it is expected to provide similar benefits.

[Facts about Prussian Blue \(CDC\)](#) — Prussian blue can be used, under the guidance of a doctor, to treat people who have been internally contaminated with radioactive cesium (mainly Cs-137) and nonradioactive thallium (once an ingredient in rat poisons).

[FAQs about a Nuclear Blast \(CDC\)](#) — CDC has developed this fact sheet to describe what happens when a nuclear blast occurs, the possible health effects, and what you can do to protect yourself in this type of emergency.

[Guidelines for Hospital Response to Casualties from Radiological Incidents \(CDC\)](#) — This document provides practical strategies for hospitals in preparing for and responding to a radiological terrorism event involving mass casualties.

[NRC's Emergency Preparedness & Response Page](#) — The U.S. Nuclear Regulatory Commission's Office of Nuclear Security and Incident Response assists emergency personnel in rapidly identifying, evaluating, and reacting to a wide spectrum of radiation emergencies, including those arising from terrorism or natural events such as hurricanes.

[Potassium Iodide \(KI\) Fact Sheet](#) — This fact sheet from the Florida Department of Health explains how KI tablets are used to protect the thyroid gland from exposure to radioactive iodine from a nuclear accident. The sheet also contains links to additional information about KI from other organizations.

[Radiation Measurement Facts & Terminology \(CDC\)](#) — This CDC fact sheet explains some of the terminology used to discuss radiation measurement.

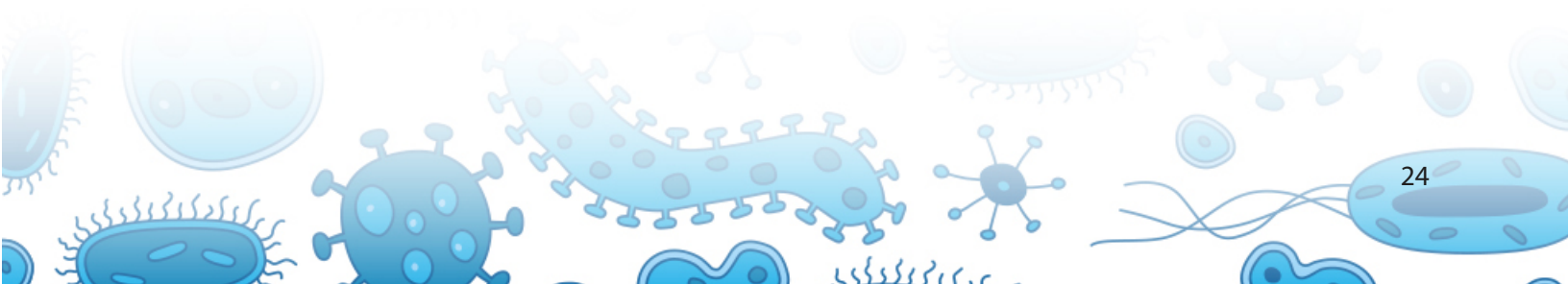

FOOD SAFETY THREATS

Food Emergency Response Network (FERN) integrates the nation's food-testing laboratories at the local, state, and federal levels into a network that is able to respond to emergencies involving biological, chemical, or radiological food contamination. The FERN structure is organized to ensure federal and state inter-agency participation and cooperation in the formation, development, and operation of the network.

Protecting the nation's food supply is paramount, but complicated. The extensive, open, interconnected, diverse, and complex structure of U.S. agriculture and food systems makes it possible targets for terrorist attacks. Several large-scale incidents in the U.S. and abroad have illustrated the potential for catastrophic health effects resulting from intentional contamination of the food supply.

The Homeland Security Presidential Directive 9 (HSPD-9) was issued in January 2004. It established a national policy to defend the agriculture and food system against terrorist attacks, major disasters, and other emergencies. https://www.aphis.usda.gov/animal_health/emergency_management/downloads/hspd-9.pdf

HSPD-9 addresses the need for the development of:

- Surveillance and monitoring systems for early detection and awareness of food contamination events
- Tracking systems
- Mitigation strategies in response to events
- Response planning and recovery activities that will be integrated into the National Response Plan
- Nation-wide laboratory networks for food, veterinary, plant health, and water quality that integrate existing federal and state laboratory resources, are interconnected, and utilize standardized diagnostic protocols and procedures

USDA FOOD DEFENSE & EMERGENCY RESPONSE

Food Defense is the protection of food products from intentional adulteration by biological, chemical, physical, or radiological agents. It addresses additional concerns including physical, personnel and operational security.

<http://www.fsis.usda.gov/wps/portal/fsis/topics/food-defense-defense-and-emergency-response>

EMERGENCY CONTACTS

- Office of Data Integration and Food Protection Main number: 202-720-5643
- Office of Data Integration and Food Protection 24-Hour Emergency Number: 1-866-395-9701
- [FBI Local Field Offices](#)
- USDA Meat and Poultry Hotline at 1-888-MPHotline or 1-888-674-6854
- [USDA FSIS Office Locations and Telephone Numbers](#)
- [State Homeland Security Advisors](#) (DHS.gov)
- [FoodSHIELD State Contacts](#) (Login Required)



FDA COUNTERTERRORISM AND EMERGING THREATS

This is the FDA's main counterterrorism information page. It contains links to general information, public health initiatives, food security, biological agents, and regulatory actions.

<http://www.fda.gov/emergencypreparedness/counterterrorism/default.htm>

FDA FOOD DEFENSE

This is CFSAN's main food defense page. It contains information on their food defense programs, training materials, and the ALERT initiative. <http://www.fda.gov/Food/FoodDefense/default.htm>

FDA CONTACT INFORMATION:

To report a non-emergency problem with an FDA-regulated product, see the Consumer Complaint Coordinators listing page. To report an Emergency with a food, drug, or medical device, Call FDA's emergency number: 1-866-300-4374 or 301-796-8240, 24 hours a day, seven days a week.

DEPARTMENT OF HOMELAND SECURITY'S CENTERS FOR EXCELLENCE

Food Protection and Defense Institute (NCFPD) <http://www.ncfpd.umn.edu/>.

NCFPD addresses the vulnerability of the nation's food system to attack through intentional contamination with biological or chemical agents. Research and education are aimed at reducing the potential for contamination at any point along the food supply chain and mitigating potentially catastrophic public health and economic effects of such attacks.

Lead Institution: University of Minnesota, Twin Cities.

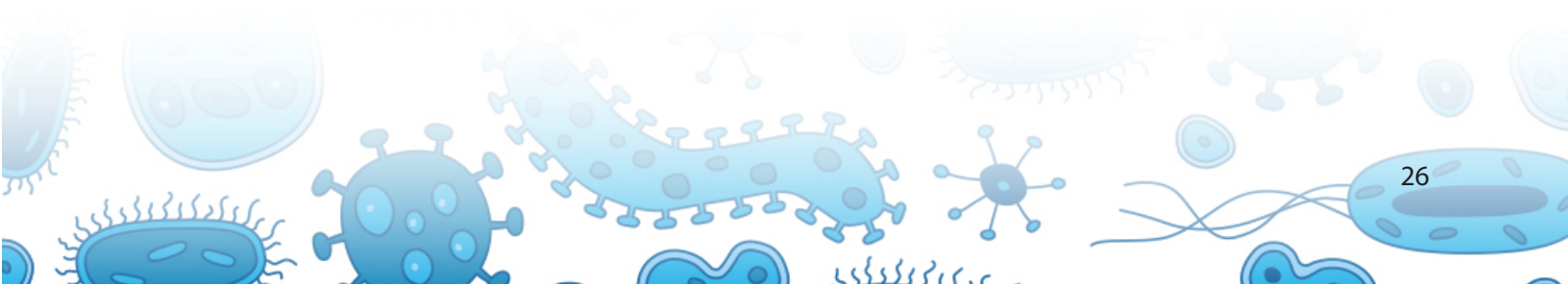

BIOWATCH PROGRAM

The function of the BioWatch Program is to detect the release of pathogens into the air, providing warning to the government and public health community of a potential bioterror event. This system is expected to provide early warning of a pathogen release, alerting authorities before victims begin to show symptoms and providing the opportunity to deliver treatments earlier, decreasing illness and death. While there is limited federal government description of the BioWatch Program, there have been media reports describing the functional concept.

The BioWatch Program uses a series of pathogen detectors co-located with Environmental Protection Agency air quality monitors. Aerosol samplers mounted on preexisting EPA air quality monitoring stations collect air, passing it through filters. These filters are manually collected at regular intervals and are analyzed by state and local health departments for potential biological weapon pathogens using polymerase chain reaction (PCR) techniques. The entire list of pathogens tested is not publicly available.

LINKS

http://www.fas.org/sgp/crs/terror/RL32152.html#_1_2

<http://www.dhs.gov/blog/2012/07/12/truth-about-biowatch>

<https://www.cfda.gov/index?s=program&mode=form&tab=core&id=49a18e5e6e67ffac19de03d52b325419>

<http://www.dhs.gov/keywords/biowatch>

<http://emergency.cdc.gov/lrn/pdf/lrnexamples.pdf>

<http://www.cdc.gov/mmwr/preview/mmwrhtml/su5401a3.htm>

http://iom.nationalacademies.org/Reports/2010/BioWatch-Public-Health-Surveillance-Evaluating-Systems-Early-Detection-Biological-Threats.aspx?_ga=1.218713433.1909702242.1453487873

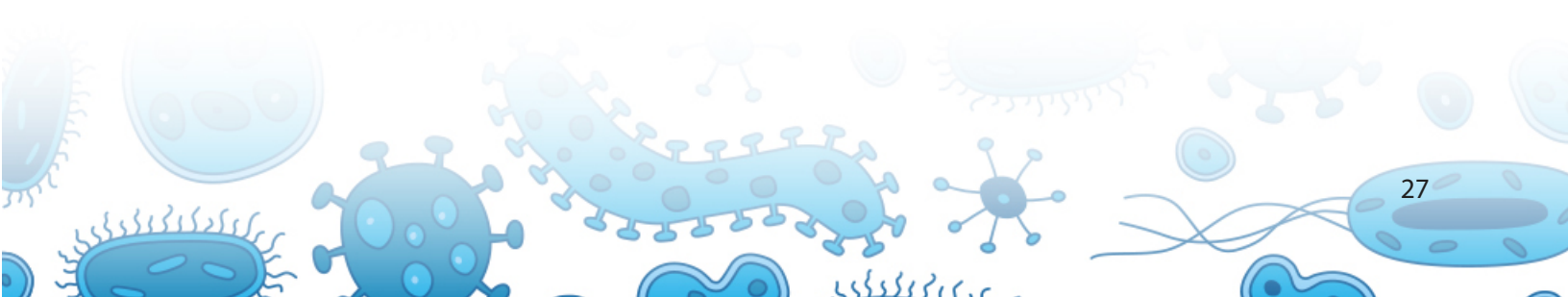

BIO DETECTION SYSTEMS – BDS

The distribution of letters laden with anthrax spores through the U.S. Postal Service (USPS) in 2001 established the mail as a feasible route of exposure. Within days of discovering that anthrax had been found in the mail system, the Postal Service commissioned the first ever, rapid test for biohazards in the mail system.

The United States Postal Service, committed to keeping its employees and customers safe, has developed a Biohazard Detection System (BDS) that will detect anthrax in the mail. The BDS - Biohazard Detection System - employs proven technology and was designed exclusively for the Postal Service. The system is designed for the highest possible level of detection.

In the event of another attack through the mail, the risk for exposure to aerosolized *B. anthracis* spores is presumed to be high among staff members working in a USPS processing and distribution center due to mechanical processing equipment that might generate aerosol particles. In response, USPS implemented environmental monitoring to rapidly identify the presence of *B. anthracis* in these centers. The BDS uses sophisticated DNA matching to detect the presence of anthrax (*Bacillus anthracis*) in the mail. It continuously collects air samples from mail canceling equipment while it is operating. Detection of *B. anthracis* using these validated USPS monitors would identify a likely exposure and allow prompt initiation of antimicrobial post-exposure prophylaxis (PEP).

In December 2002, the Postal Service awarded the BDS System manufacturers a pre-production contract to expand and continue testing the system. A contract for the initial purchase of 742 units was awarded in May of 2003. The annual expenses associated with the devices were between \$75 million to \$100 million. Installation was finished in 2006. Since the deployment of the BDS at all 321 Postal plants in the nation, there have been no positive alerts for anthrax.

HOW DOES THE BIOHAZARD DETECTION SYSTEM FUNCTION?

BDS equipment collects samples of air as the mail moves through a canceling machine.

- The BDS absorbs the airborne particles into a sterile water base. This creates a liquid sample that can be tested.
- The liquid sample is injected into a cartridge, and the automated test for a DNA match is performed.
- **Note:** All the BDS processes are automated.
- The BDS unit consists of an air-collection hood, a cabinet where the collection and analysis devices are housed, a local computer network connection, and a site controller – a networked computer.

Why is the BDS Needed?

- The BDS will enable early identification of anthrax providing for a rapid response.
- BDS helps us maintain our commitment to keep employees and customers safe.



What is the Science Behind the Biohazard Detection System?

- The core of the system is PCR. It is a process that essentially “photocopies” the genes of a sample and compares the sample to a template for the anthrax DNA sequence to see if there is a match.

When is a BDS Test Complete?

- After approximately 90 minutes – one hour for the air collection process and 30 minutes to test the air sample.
- Since air sample collections are continuous, test results will be known every hour after the initial test.

How Many Air Samples Are Taken During the Day?

- Continuous air collection will take place while the mail canceling operation is underway. There are no gaps.

How Do You Find Out if There is a Positive Match?

- If there is a DNA match, the BDS computer network conveys that information to the site controller computer.
- The red stack-light and horn at the BDS cabinet alerts personnel of a positive result.

Can the BDS Equipment Test for Other Biohazards?

- For purposes of nationwide deployment, the system is fully capable of testing for anthrax.
- The system is “expandable,” so, in the future, it could be adapted to test for other biological threats.

WHAT IS THE BIOHAZARD SYSTEM’S IMPACT ON MAIL PROCESSING?

- BDS does not slow down mail processing equipment.
- If the BDS tests positive for anthrax, mail will be retained at the impacted facility until it is safe for delivery.
- If operations are suspended at a facility, new mail will be diverted to other mail processing facilities and delivery operations will proceed from there.

WHAT IS THE PROCEDURE IF A BIOHAZARD IS DETECTED?

What Happens When the Alarm Goes Off?

- If test results indicate the presence of a biohazard, the BDS alerts designated site personnel through automated procedures and the red stack-light and horn at the BDS cabinet will sound.
- Designated site personnel will then activate the emergency action plan.
- Employees and customers will be evacuated from the building.



Once the Postal Employees are Outside the Building, What Will Be Done for Their Safety?

- Supervisors will call the roll and make sure everyone in the building has been evacuated.
- They will explain the nature of the incident, and everyone will wait for direction from community emergency response personnel.

Will Medication Be Offered?

- Local public health officials will determine the need for medication based on results of additional tests of the positive BDS sample by the designated local public health lab.

When Will an Outside Lab Result be Available?

- Results of the initial test, verifying the positive sample, will be available approximately eight hours after the BDS alert.
- Results of the second test, a plate culture test, will be available usually within 24 to 48 hours after the BDS alert.
 - **Note:** The Department of Homeland Security will be notified of a positive test result.

LINKS:

<http://www.apwu.org/issues/bio-detection-systems>

<http://www.cdc.gov/mmwr/preview/mmwrhtml/rr5906a1.htm>

<http://about.usps.com/news/state-releases/sc/2013/FAQ-BDS.pdf>

<https://postalinspectors.uspis.gov/investigations/mailfraud/fraudschemes/dmi/dmi.aspx>

<http://www.tern.com/portal/content.asp?contentid=875>

<http://www.nti.org/gsn/article/postal-service-prepared-for-future-anthrax-attacks/>

<http://www.gpo.gov/fdsys/pkg/CFR-2004-title39-vol1/pdf/CFR-2004-title39-vol1-sec233-10.pdf>

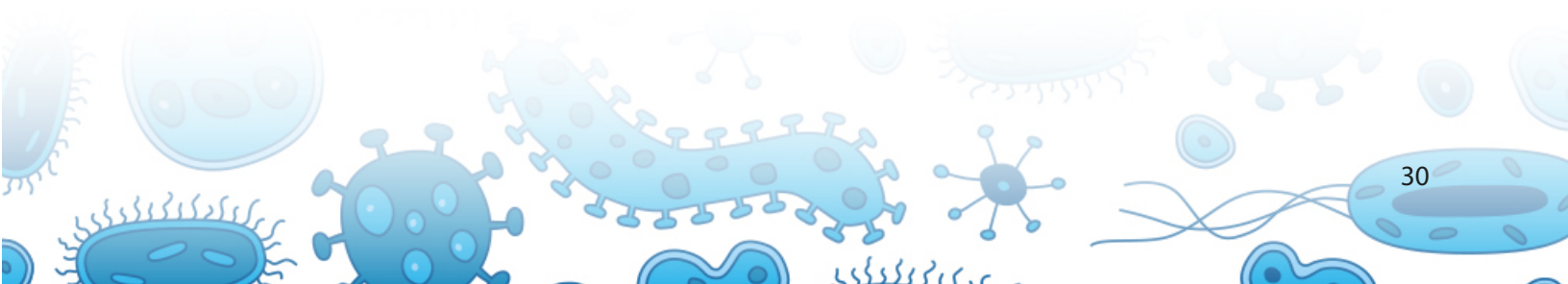

BIOSAFETY BASICS

BIOSAFETY DEFINED

Biosafety is the combination of appropriate work practices, safety equipment (including personal protective equipment (PPE)), and facility design employed to contain potentially infectious microorganisms and hazardous biological materials (e.g., toxins), to reduce the exposure risk to workers, the environment and the public and to prevent laboratory acquired infections (LAIs). Some infectious organisms present in patient specimens can be highly infectious and can result in serious or even fatal illnesses.

DATE APPROVED:

8 / 1 / 2016

There is always some risk when working with infectious agents, therefore the goal of a good biosafety program is to reduce the risk to an acceptable level. The acceptable level will be determined by the Laboratory Director and institutional management, and can vary depending on risk tolerance levels and institutional policies.

BIOSAFETY LEVELS

There are four biosafety levels (BSLs), BSL-1 through BSL-4, with BSL-1 providing the lowest level of protection and BSL-4 providing the highest level of protection. Biosafety levels consist of a combination of laboratory practices and techniques, safety equipment and laboratory facilities. You may hear biosafety levels described as the level of containment necessary for certain types of work or working with specific microorganisms. At its very essence, the practices, equipment and facility criteria designated for each BSL are intended to contain the infectious organisms to prevent exposure to the workers and the environment.

At a minimum, clinical laboratories that perform high complexity microbiology should be BSL-2 labs. Some clinical labs might be at a BSL-3 level due to their work with agents that carry a high risk of causing a serious infection if inhaled, such as *Mycobacterium tuberculosis*.

The Biosafety in Microbiological and Biomedical Laboratories (BMBL), 5th Edition (download it at: <http://www.cdc.gov/biosafety/publications/bmbl5/index.htm>) describes the different biosafety levels in detail. It also lists standard microbiological practices that laboratorians should follow in their daily work. Some of the practices and techniques, safety equipment and PPE (primary barriers), and facility design and construction safeguards (secondary barriers) for BSL-2 and BSL-3 laboratories are included here.

SAFE LABORATORY PRACTICES

In a laboratory, many standard safety practices should be a part of the lab-specific safety manual and should be practiced daily by employees. Each laboratory worker plays a large role in their own protection. Improperly using safety equipment and not following safety protocols can lead to safety breaches. This list includes some of the key standard microbiological practices. For a full list, see the Biosafety Level 1, 2, and 3 sections of the BMBL, 5th edition.

1. Before beginning any new procedure or handling a new organism, it is very important to perform a risk assessment. Please see the risk assessment section of this manual for more details.
2. Limit access – Only authorized personnel should be able to enter work areas.
3. Wash hands – Always wash hands after handling a sample or organism and before leaving the lab.
4. No eating, drinking, handling contact lenses, applying cosmetics or storing food in the laboratory.
5. No mouth or eye contact – Touching these areas could cause accidental ingestion or mucous membrane exposure. Consider policies to restrict the use of personal electronic devices.
6. Avoid using sharps whenever possible. Substitute plastic for glass when feasible. Have procedures addressing disposal.
7. Limit or contain aerosols.
8. Decontaminate work surfaces.
9. Decontaminate infectious waste.
10. Post biohazard warning signs to inform workers they are entering a biohazardous area.
11. Implement a pest management program.
12. Ensure effective training in procedures and biosafety.

BSL-2 (See [BSL2 Checklist for Clinical Laboratories 090815 Job Aid](#))

1. Ensure laboratory personnel have specific training and demonstrate proficiency prior to handling pathogenic agents.
2. Restrict access to the laboratory while work is being performed.
3. Perform all procedures involving infectious materials, which may produce an aerosol or splash, inside a biological safety cabinet (BSC) or other physical containment device.
4. Post warning signs incorporating the universal biohazard symbol at the entrance to the laboratory and on containers of potentially infectious materials as specified in the OSHA Bloodborne Pathogens Standard 29 CFR 1910.1030.
5. Develop and implement policies for the safe handling of sharps.
6. The facility should have a comprehensive and lab-specific biosafety manual that includes how waste is decontaminated and medical surveillance policies.
7. PPE should include long cuffed-sleeved and closed lab coats, gloves, and face and eye protection as identified by your facility's risk assessment.
8. A handwashing sink and eyewash station must be available. Persons must wash their hands after working with potentially infectious materials, when gloves are contaminated and before leaving the laboratory.
9. Personnel must be trained on the precautions to prevent exposure as well as the emergency procedures to follow in the event of an exposure. Medical surveillance and appropriate immunizations must be offered.
10. Decontaminate all work surfaces with appropriate disinfectant after completion of work and after any spill or splash of potentially infectious material.
11. Decontaminate all cultures, stocks, and other potentially infectious materials using an effective method before disposal. Depending on where the decontamination will be performed, the following methods should be used prior to transport:

- a. Place materials to be decontaminated outside of the immediate laboratory in a durable, leak proof container and secured for transport.
- b. Pack materials to be removed from the facility for decontamination in accordance with applicable local, state, and federal regulations.

Note: Not having an autoclave in the immediate lab does not exclude the lab from being designated as a BSL-2. Using an autoclave somewhere else in the facility or sending waste out for destruction and disposal by an outside vendor is acceptable as long as it is packed and transported in accordance with all applicable local, state and federal regulations.

BSL-3 (See [BSL3 Checklist for Clinical Laboratories 090815 Job Aid](#))

1. Meet all BSL-2 criteria.
2. Conduct all manipulations of infectious materials within a BSC or other containment device. Never manipulate infectious material on an open bench.
3. Restrict access to the laboratory to authorized personnel.
4. Decontaminate all waste before leaving the facility for final treatment and/or disposal.
5. Decontaminate reusable PPE (e.g., PAPR) before reuse. Decontaminate reusable laboratory clothing (e.g., scrubs) before laundering.
6. Additional PPE may include a solid-front wrap around gown, gloves, face and eye protection, and respiratory protection as indicated by the risk assessment.
7. The lab is physically separated from areas that are open to unrestricted traffic flow.
8. Entry into the BSL-3 is through two self-closing and lockable doors and may include an anteroom.
9. Ensure air exhausted from the lab isn't recirculated to any other area of the building (single pass).
10. Maintain and monitor sustained directional inward airflow into the laboratory.
11. Ensure a hands-free hand washing sink is located near the lab's exit.



LABORATORY EXPOSURES AND LAB ACQUIRED INFECTIONS (LAIs)

Laboratory exposures and Laboratory Acquired Infections (LAIs) can occur from a breakdown of the established safety protocols. More stringent safety protocols, aerosol prevention and containment are often associated with agents of bioterrorism, but other more common infectious organisms can also cause LAIs. Routinely following established safety protocols for all patient samples (i.e., Standard Precautions and site-specific safety measures based on risk assessments) will help to protect against LAIs. Your facility should also have an official surveillance mechanism for reporting, monitoring and treating LAIs.

The most predominant routes of transmission that cause LAIs and suggestions for addressing them:

1. Sticks or cuts with contaminated needles or other sharps
 - a. Remove glass and sharps from your procedures when possible.
 - b. Have procedures for proper sharps use and disposal, if used.
2. Spills or splashes directly onto skin or mucous membranes (eyes, nose, mouth)
 - a. Provide PPE to workers and ensure they are trained to use it properly.
 - b. Have procedures for addressing spills and splashes.
3. Ingestion
 - a. Make sure workers know that mouth pipetting is never acceptable.
 - b. Avoid touching the face while in the lab.
 - c. Practice frequent hand washing.
4. Indirect exposure through touching the mouth or eyes with contaminated fingers or objects (fomites)
 - a. Train workers on the proper procedures and precautions to prevent exposures including PPE usage/doffing and hand washing.
 - b. Avoid touching the face while in the lab.
5. Animal bites or scratches (i.e., research facilities where animals are kept)
6. Inhalation of infectious aerosols
 - a. Work inside a BSC when there is a risk of a splash or creating an aerosol.
 - b. Use appropriate procedures and containment devices to avoid creating an aerosol.

Data suggests that infectious aerosols play a large role in LAIs. These sources of LAIs, especially aerosol prevention and containment, should be addressed in your laboratory's safety manual.

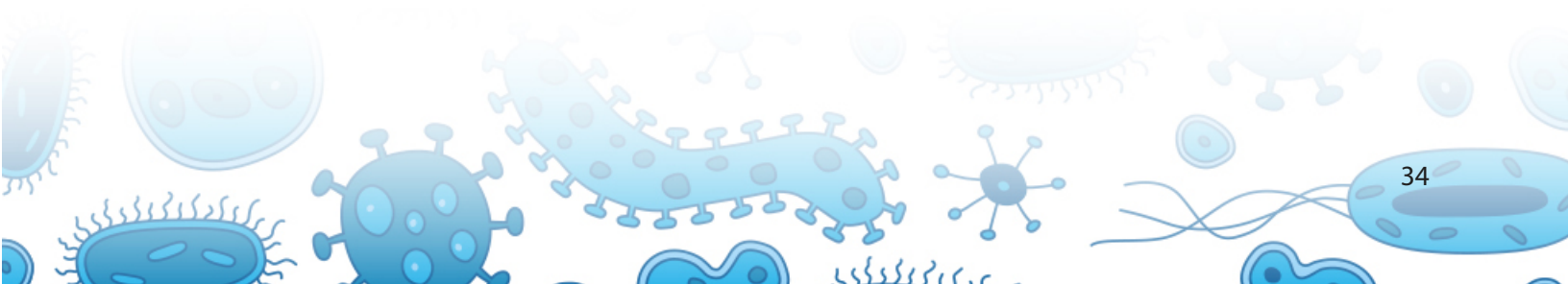

AEROSOL AND DROPLET PRODUCTION

Any procedure which imparts energy to a microbial suspension can produce aerosols or droplets, which may contain infectious organisms. Aerosols are very small particles that may remain suspended in the air and can be inhaled and retained in the lungs. Droplets are larger particles which settle onto surfaces and gloves due to gravity. Droplets may also come into contact with the mucous membranes of the person performing the procedure. Sealed containers, sealed rotors, centrifuge safety cups and biological safety cabinets should be used to mitigate the risk of creating aerosols and droplets. Some of the most commonly recognized procedures which can cause aerosols and droplets and ways to mitigate the risks are listed below.

1. Pipetting

- a. Perform work inside a BSC.
- b. Do not forcibly expel the last drop of fluid from the pipette tip. Instead, place the tip against the inside wall of the vessel and expel the last drop as gently as possible.
- c. Pipette volumes are calibrated to be accurate at the first "To Deliver" stop. There is no need to continue to push to the "Expel" stop to preserve pipetting accuracy.
- d. Instead of mixing a dilution or sample with a pipette, cap the tube and use a vortex mixer.
- e. Never direct the pipette stream into the middle of the well or container, instead touch the tip to the inside of the well or container. This reduces the energy and splashing.
- f. Use aerosol resistant pipette tips to protect against contamination inside the pipette.
- g. Drips that hit a hard surface can produce an aerosol and droplets. Use plastic backed bench pads to absorb and contain any falling drips. When possible, lower the pipette tip toward the bench pad before the drip falls to reduce the distance and amount of energy.

2. Tubes and vessels – Breaking films and opening containers

- a. Breaking or popping thin films in the neck of containers can cause aerosols and droplets. Instead, recap the tube and centrifuge it.
- b. If centrifugation is not possible because of the vessel type, then cover the opening with an absorbent material and insert a pipette under the material to break the film. Discard the pipette and the absorbent material with the contaminated waste.
- c. Plug or pop top microcentrifuge tubes can produce splatter when they are opened. Using screw cap tubes will minimize splatter.
- d. Before opening microcentrifuge tubes, quickly spin them in your centrifuge to remove excess fluid from the lid.
- e. Open microcentrifuge tube inside a BSC whenever possible.
- f. To open plug top tubes, cover the plug with an absorbent material moistened with alcohol, point the tube away from your face and open it inside a BSC or other containment device. Dispose of the absorbent material with the contaminated waste.

3. Vortex mixing

- a. Never vortex an open container or tube. Always securely close containers before vortexing.
- b. Use caution when opening containers following vortexing since fluid may have reached the lid. Either quick spin the tube in a centrifuge or cover the lid with absorbent material moistened with an appropriate disinfectant. Dispose of the absorbent material with the contaminated waste.



- c. Open containers inside a BSC whenever possible.
- 4. Performing catalase test
 - a. Perform catalase testing inside a BSC, a closed tube, or a closed petri dish.
 - b. For the tube catalase testing method, place organism growth onto the wall of a test tube. Run the catalase reagent down the opposite wall and into the bottom of the tube. Cap the tube. Tilt the tube so the reagent touches the organism. Read the result.
- 5. MALDI-TOF Identification
 - a. If your laboratory uses Mass Spectrometry (MALDI-TOF) for bacterial identification, and if the manufacturer provides your facility with an alternate tube extraction method, it is recommended that the resulting extract be filtered using a 0.2 u (or less) filter. This additional step is recommended to reduce the chance of laboratory contamination with viable bacteria and spores.

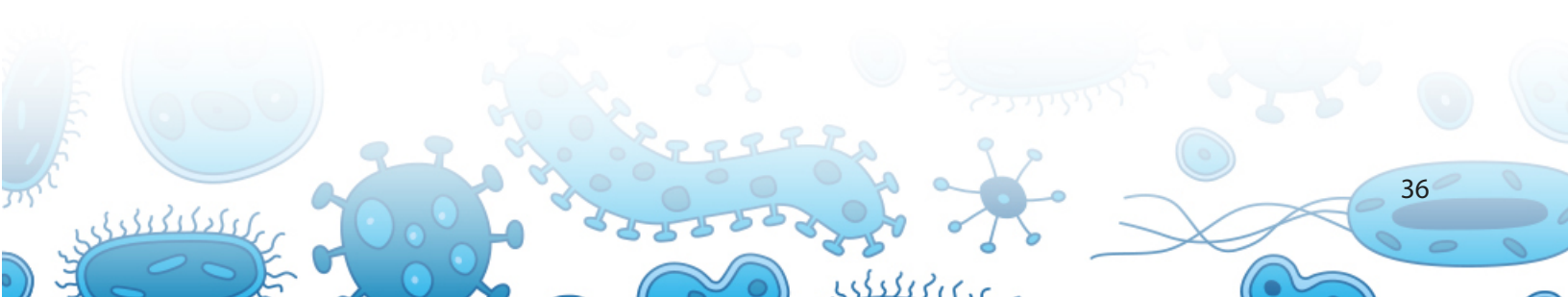

BSL-3 PRACTICES AND WHEN TO USE BSL-3 PRACTICES IN A BSL-2 LABORATORY

BSL-3 PRACTICES

1. Restrict access to the laboratory.
2. Wear additional PPE (solid-front gown, gloves and face/eye protection as a minimum).
3. Lab personnel must **demonstrate proficiency** prior to handling pathogenic and potentially lethal agents, and must be supervised by scientists experienced and competent in handling the specific infectious agents present in the lab and associated procedures.
4. Do not manipulate organisms or work in open vessels on the bench – All work must take place in a BSC or other containment equipment.
5. Evaluate all potential exposures immediately.
6. Decontaminate all cultures, stocks and other potentially infectious materials prior to disposal by using an approved decontamination method, such as autoclaving or chemical disinfection.
Decontamination would preferably take place within the Laboratory.

WHEN TO USE BSL-3 PRACTICES IN A BSL-2 LABORATORY

1. When working with agents that can be transmitted via inhalation and are normally handled at BSL-3, but a BSL-3 laboratory is not readily available.
2. When the laboratory director determines that these practices are needed based on a risk assessment
3. When specific high-risk pathogenic organisms are suspected (such as *Brucella spp.*, *Coccidioides*, *Blastomyces dermatitidis*, *Francisella tularensis*, *Histoplasma capsulatum*, *Mycobacterium tuberculosis*, etc.)

BIOSAFETY CABINET USAGE AND TESTING

Clinical laboratories should have at least one Class II BSC. Training on proper BSC usage must be given to laboratorians before they are allowed to work in a BSC. Without proper training, users can unknowingly put themselves at risk. The training should include what to do if there is a power or BSC failure while they are working with samples in the BSC.

WHEN TO USE A BSC

The BSC should be used when your facility's management has determined it to be necessary. At a minimum, the BSC should be used any time you are working with an infectious agent where:

1. Procedures with potential for creating infectious aerosols or splashes are conducted.
2. The infectious agent is present in large volumes or high concentrations.
3. The organism is suspected to be highly infectious, especially through inhalation (airborne) route of transmission.
4. The suspected organism is believed to cause severe or fatal infections.

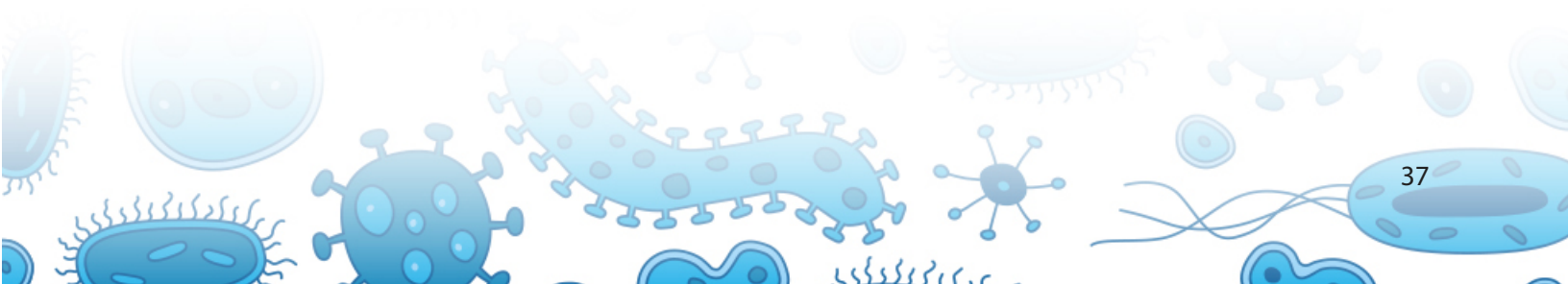

WHERE TO PLACE YOUR BSC

Where your BSC is located is important. When used properly, the inward airflow and air filtration in the Class II BSC are designed to protect the user, the product and the environment. However, this airflow can be easily disrupted by improper personnel practices and by its surroundings. When placing a new BSC or moving an existing BSC, make sure to locate the BSC away from other work and high traffic areas. Also locate it away from air supply ducts and lab entry doors. If your BSC is currently located near one of these sources of air disturbances, try to mitigate air disruption while work is occurring in the BSC. Close doors and post signs to minimize personnel walking past the BSC. Directional air diffusers may be an option to direct airflow away from the BSC.

BSC CERTIFICATION REQUIREMENTS

All BSCs must be certified at least annually by a trained professional to meet Annex F of *ANSI/NSF Standard 49* requirements. Annual certification ensures that the BSC is functioning properly. Additionally, if the BSC is moved then the unit must be re-certified before it can be used. Do not use any BSC which has not been properly certified.

BSC SAFE USAGE PARAMETERS

1. If your BSC doesn't run all the time, then turn it on and allow it to run for 10 minutes before use. Decontaminate the work surface, rear wall, sides, and inside front window of the BSC with a fresh 1:10 household bleach* solution followed by 70% alcohol (or water). Use a "Swiffer" type tool to clean the back wall, if needed. Do not put your head inside the BSC to clean it.
2. Check the sash level to ensure it is set to the correct height and make sure the alarms and blower are on.
3. Check the differential pressure (e.g., magnehelic) gauge, if present, to ensure there has not been a large change from the previous usage. Record this number on your BSC usage sheet. Large changes in the pressure gauge can indicate that the HEPA filter has been breached or blocked. Don't use the BSC if this occurs, call for service.
4. Use a strip of tissue paper or a smoke stick to check for inward airflow.
5. Adjust your chair height so that your face is above the front sash opening and your underarms are near the bottom of the glass screen.
6. Gather all of the items that you will need and place them in the BSC. Only place items that you must have into the BSC. Too many items will disturb the airflow.
7. Put a small waste disposal and sharps container inside the BSC.
8. Make sure that the front or back airflow vents (i.e., grills) are not blocked.
9. Don't use volatile or highly flammable chemicals inside the BSC. BSCs are not designed to clean chemical vapors from the air and they are not spark proof. Also, don't use open flames in the BSC.
10. Only one person should work inside the BSC at a time. More than one person can disturb the airflow.
11. Move your hands straight into and out of the BSC (perpendicular to the cabinet).
12. Keep clean items separate from dirty items. (e.g., clean items on your left and dirty on your right.)
13. Work 4-6 inches into the BSC. This is where the airflow is optimal for protecting the user and the work product.

14. Work in a slow and methodical manner. Don't make any sweeping motions with your arms.
15. Clean up spills promptly with a disinfectant effective against the infectious agent that is present

* From Guidelines for Safe Work Practices in Human and Animal Medical Diagnostic Laboratories: To be an effective disinfectant, working bleach solutions must contain >0.5% but <2% sodium hypochlorite. Hypochlorite concentration in household bleach varies by manufacturer. Many household bleach solutions contain 5.25% sodium hypochlorite, and a 1:10 dilution (5,000 ppm Cl) will produce a 0.53% hypochlorite solution. Use of bleach solutions with lower hypochlorite concentrations might not provide the proper level of disinfection. Each day, prepare a fresh 1:10 household bleach solution.

ONCE WORK IS COMPLETE - BSC CLEANUP

1. Disinfect all materials with a fresh 1:10 household bleach* solution before removing them from the BSC. This includes the outsides of plates, carriers and pipettors.
2. Close the biohazard waste bag and disinfect the outside before removing it from the BSC.
3. Leave the BSC running for 10 minutes to clear all aerosols and infectious substances.
4. Decontaminate the work surface, rear wall, sides, and inside front window of the BSC with a fresh 1:10 household bleach* solution followed by 70% alcohol (or water). Use a "Swiffer" type tool to clean the back wall, if needed. Do not put your head inside the BSC to clean it.

DEMONSTRATING INWARD BSC AIRFLOW USING A SMOKE STICK

1. Pass the smoke stick along the entire perimeter of the BSC work opening, approximately 1.5 inches outside of the cabinet.
2. Pay particular attention to corners and vertical edges.
3. The smoke should be drawn into the front grill. When testing closer to the sash, the smoke will look curlier since it is farther from the grill.

Note: Don't hold the smoke stick any further than 1.5 inches outside of the BSC. The BSC is not designed to draw air in from great distances outside of the BSC.

DISINFECTING WORK SURFACES

1. Clean work surfaces and work items before work is set up and after work is completed. This includes work benches, timers, pens, telephones and any other surfaces that have been touched by a sample or a gloved hand.
2. Instructions for disinfecting these work surfaces must be part of the labs Standard Operating Procedures (SOPs). The SOP should detail what disinfectant to use, what PPE to wear, how to clean the surfaces, what contact time is required and how to dispose of the cleaning materials.
3. If possible, post these cleaning instructions in the bench area for easy reference.
4. Typically a freshly made 1:10 household bleach* solution followed by a 70% alcohol dilution is sufficient to disinfect most surfaces. If your facility has another disinfectant that is more suited to the work being performed or surfaces being cleaned, then it may be used instead.



5. In general, remove gross contamination before applying disinfectant. Disinfectants are less effective with organic material present. Allow dried blood or body fluid at least 20 minutes of contact with the bleach solution or other approved disinfectant before clean-up.

SPILL CLEANUP

1. Clean up spills immediately. Put on appropriate PPE: gown, gloves, shoe covers and facemask as needed.
2. Cover the spill with an absorbent material such as paper towels.
3. In general, remove gross contamination before applying disinfectant. Disinfectants are less effective with organic material present.
4. Gently pour a freshly made 1:10 household bleach* solution around the outside of the spill. Continue to go around the spill while decreasing the size of the circle until the whole spill, from outside to inside, is covered in bleach.
5. Let sit for 20 minutes (or for the appropriate contact time based on the disinfectant used).
6. Remove all spill cleanup materials and place them with the infectious waste for proper disposal.
7. Wipe down the area with a freshly made 1:10 household bleach* solution, followed by 70% alcohol.
8. Put the remaining cleanup materials and PPE into the infectious waste disposal.

CREATING A CULTURE OF SAFETY ([A Biosafety Checklist: Developing A Culture of Biosafety](#))

Establishing a culture of safety begins with the support of the facility's management. Laboratory safety must become an integral part of your laboratory's every day operations and an obvious priority for your organization. Management embracing the importance of safety and providing guidance and infrastructure support will foster safe behavior among the employees. In order to establish a culture of safety, facilities need to:

1. Establish and enforce laboratory safety policies.
2. Conduct risk assessments to identify potential hazards and specify practices and procedures to mitigate or reduce the risk of exposure to those hazards.
3. Ensure that personnel understand how to perform a risk assessment and identify hazards in their work environment.
4. Ensure all personnel are trained to safely perform their work including practices to minimize identified risks. Observe them to ensure they are competently performing these techniques.
5. Provide a non-punitive avenue for workers to identify risks and communicate concerns and mitigation strategies to management without fear of punishment.

DECONTAMINATION OF SELECT AGENTS ISOLATED IN THE CLINICAL LABORATORY

(See [DecontaminationSelectAgents JobAid 10_06_2015 Final Job Aid](#))

Select agents (www.selectagents.gov) cannot be directly discarded into the biohazardous waste stream like other regulated infectious medical waste materials. Select Agent regulations detailed in 7 CFR 331, 9 CFR 121 and 42 CFR 73 dictate that select agents may only be held more than 7 days from confirmation by facilities that are registered and approved by CDC and/or USDA to possess those specific select agents. Once an isolate

from a patient specimen in the clinical lab has been confirmed by the local Laboratory Response Network (LRN) Reference Laboratory as a select agent, the non-registered clinical lab must **destroy** all relevant patient specimens and cultures remaining in their possession, **or transfer** them to the nearest LRN laboratory that is registered for those select agents.

If a clinical lab decides to **destroy the patient specimens and cultures**, inactivation using an on-site autoclave or chemical decontamination must be performed before transport to a medical waste contractor for destruction and disposal.

Chemical Decontamination Process

1. Prepare a fresh 1:10 household bleach* solution in a receptacle large enough to submerge all containers/plates containing select agents.
2. Working in a BSC, completely immerse open culture containers in the bleach solution and leave containers in bleach solution overnight.
3. Once overnight inactivation is complete, turn the sink faucet on and discard the bleach solution down the drain with running tap water.
4. Package the inactivated culture plates and containers with other biohazardous waste that is transported off site by a medical waste management contractor for final treatment and disposal.

If a clinical lab chooses to **transfer the relevant specimens and cultures**, lab personnel will need to work with the LRN Reference Laboratory to ensure that the proper paperwork and transfer protocols are followed in compliance with all applicable local, state, and federal shipping regulations.

Note: If an organism is subcultured from a blood culture bottle and a LRN Reference Laboratory confirms the organism as a select agent or the patient is diagnosed with smallpox or a VHF, the blood culture bottles and any additional bottles that would contain the organism, must be decontaminated before transport off site. The contents in these bottles cannot be adequately decontaminated using chemical decontamination and must be autoclaved on site. If the facility does not have an autoclave on site, all positive blood culture bottles must be transferred to the closest LRN Reference Laboratory registered and approved to accept the select agent.

REFERENCES

1. CDC/National Institutes of Health. Biosafety in Microbiological and Biomedical Laboratories. 5th edition.
2. CDC. Guidelines for Safe Work Practices in Human and Animal Medical Diagnostic Laboratories. MMWR 2012;61:supplement 1-105

* From Guidelines for Safe Work Practices in Human and Animal Medical Diagnostic Laboratories: To be an effective disinfectant, working bleach solutions must contain >0.5% but <2% sodium hypochlorite. Hypochlorite concentration in household bleach varies by manufacturer. Many household bleach solutions contain 5.25% sodium hypochlorite, and a 1:10 dilution (5,000 ppm Cl) will produce a 0.53% hypochlorite solution. Use of bleach solutions with lower hypochlorite concentrations might not provide the proper level of disinfection. Each day, prepare a fresh 1:10 household bleach solution.

BIOLOGICAL RISK ASSESSMENT

The purpose of a biological risk assessment (RA) is to identify the hazards associated with handling infectious agents in the laboratory and to identify and implement controls in order to minimize the risk of exposure to workers and the environment. In the clinical lab, biological risk assessments focus primarily on the prevention of laboratory-acquired infections (LAIs) from:

DATE APPROVED:

8 / 1 / 2016

- Spills/splashes to mucous membranes
- Inhalation of aerosols
- Percutaneous inoculation from cuts, needle sticks, non-intact skin
- Ingestion (contamination from surfaces, fomites to hands)

Laboratory acquired infection prevention is accomplished by blocking the routes of transmission and breaking the chain of infection. The use of engineering controls, safety equipment, administrative controls, proper work practices, and personal protective equipment (PPE) are the primary means of preventing transmission of the organisms to a portal of entry in the host (i.e., lungs, non-intact skin, GI tract, mucous membranes). These controls can be followed by vaccination and/or treatment.

Surveys of clinical laboratories have revealed that exposure to aerosols was a plausible but unconfirmed source of infection in 80% of LAIs. The results indicated that *Brucella* spp. and *N. meningitidis* were the greatest risk to clinical microbiologists. The analysis of two studies, spanning 1979-2004, revealed 31 cases of invasive *N.meningitidis* infection which resulted in 11 fatalities (>35% mortality).

Some other organisms that have caused LAIs in clinical laboratories are:

- Arboviruses
- *Coxiella burnetii*
- Hantavirus
- Hepatitis C virus
- Hepatitis B virus
- *Mycobacterium tuberculosis*
- *Salmonella* spp.
- *Shigella* spp.

A risk assessment (RA) requires management involvement and support, knowledge of the hazards, and understanding of the work, the environment, and the staff. Ideally, a multidisciplinary team (depending on the work) will be involved in the RA process. That team should include:

- Laboratory staff
- Management/supervisors
- Health and safety specialists (biosafety, occupational health, etc.)
- Facility staff
- Scientists with unique expertise and experience with the potential hazards (i.e., microbiologists, molecular biologists, chemists)
- Veterinarians (if animal work)

COMPLETE A RISK ASSESSMENT WHEN:

- There is an incident, accident or exposure.
- Changes occur such as:
 - Moving, renovation or building a facility.
 - Working with a new infectious agent or reagent.
 - Using a new piece of equipment, a new technique or procedure.
 - New scientific information becomes available.

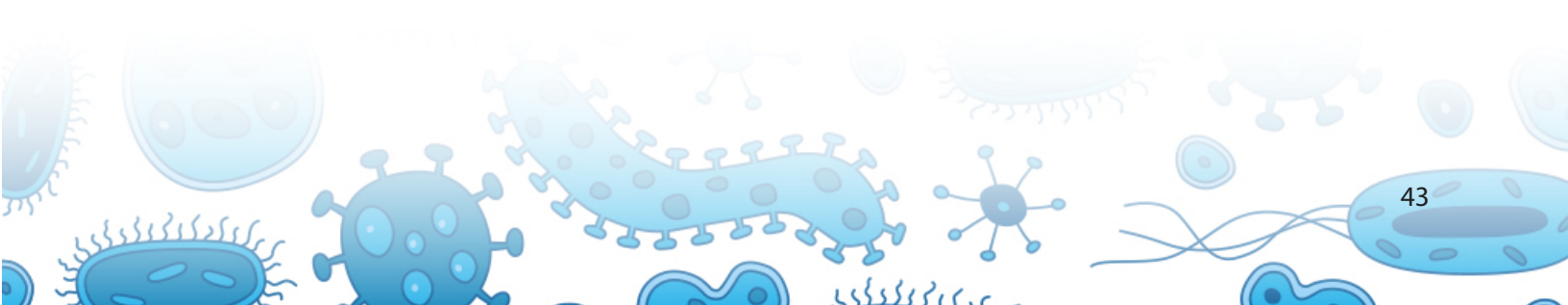

RISK ASSESSMENT: A 5-STEP PROCESS INVOLVING HAZARD IDENTIFICATION AND HAZARD CONTROL

STEP 1: IDENTIFY HAZARDS

How do you know what to include in a biological risk assessment? The 5 P's can help! Each P represents a process or category that needs to be assessed.

1. Pathogen (Agent), e.g., infectious dose, virulence factors, route of transmission, etc.
2. Procedures, e.g., centrifugation, generation of aerosols, sharps, waste management, etc.
3. Place (laboratory facility/environment), e.g., research, clinical, production, workflow, equipment, etc.
4. People, e.g., immune status, behavioral factors
5. Personal Protective Equipment, type? hazard or protection?

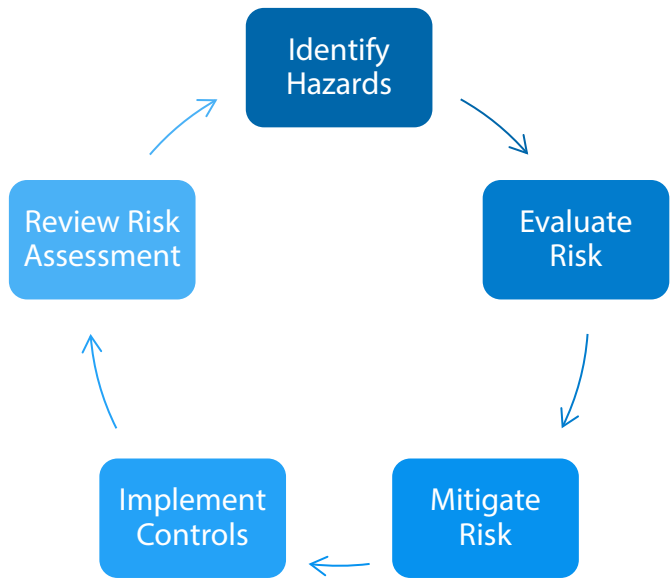

STEP 2: EVALUATE AND PRIORITIZE RISKS

Evaluate and prioritize risks based on the probability and consequences of exposure. Consider how likely the situation is to occur and how severe would the consequences be. Use a risk matrix to help prioritize risks, then determine acceptable risk and protect against unacceptable risk.

STEP 3: MITIGATE RISK

Mitigate risk by determining controls to reduce the risk. The hierarchy of controls consists of:

1. Engineering controls (e.g., safety equipment and facility design).
2. Administrative controls and work practices (e.g., training, medical surveillance, SOPs, minimizing aerosols, frequent hand washing).
3. PPE (as a last resort).

STEP 4: IMPLEMENT CONTROL MEASURES

STEP 5: REVIEW RISK ASSESSMENT

Evaluating the effectiveness of the controls and adjust the control plans when necessary.

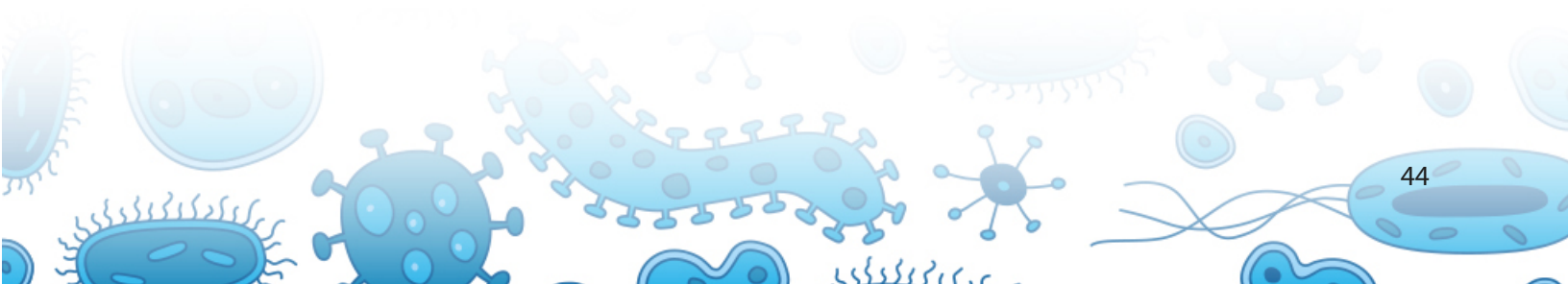

JOB HAZARD ANALYSIS

One approach to completing a risk assessment is by doing a job hazard analysis:

1. Break procedure down into individual components.
2. Determine hazard(s) associated with individual component (hazard ID).
3. Identify way to deal with each hazard (hazard control).

In conclusion, there is risk in everything that we do.

- Know the hazards
- Ask questions
- Don't forget your staff, their expertise and training

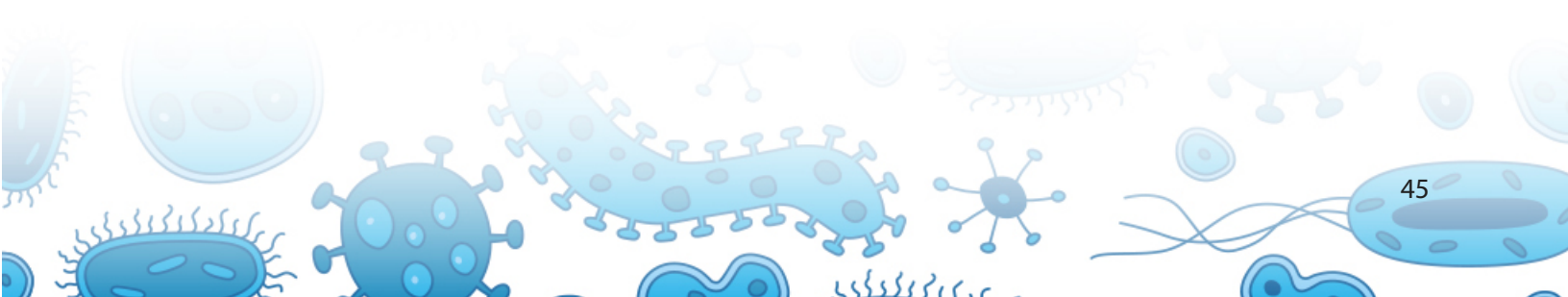

BIOSECURITY BASICS

BIOSECURITY DEFINED

Biosafety and biosecurity are related, but not identical, concepts. Biosafety programs reduce the risk of exposure of individuals and the environment to potentially hazardous biological agents. Biosafety is achieved by implementing various degrees of laboratory control and containment, through laboratory design and access restrictions, personnel expertise and training, use of containment equipment, and safe methods of managing infectious materials in a laboratory setting.

The objective of biosecurity is to prevent loss, theft or misuse of microorganisms, biological materials, and research-related information. This is accomplished by implementing policies and procedures, tracking inventory, and limiting and monitoring access to facilities, biological materials and information. While the objectives are different, biosafety and biosecurity measures are usually complementary.

DATE APPROVED:

8 / 1 / 2016

Biosafety – Protects people from dangerous pathogens.

Biosecurity – Protects pathogens from dangerous people.

BIOSECURITY AND SELECT AGENTS

Select Agents and toxins are pathogens or biological toxins that have been declared by the U.S. Department of Health and Human Services (DHHS/CDC) and by the U.S. Department of Agriculture (USDA) to have the potential to pose a severe threat to public health and safety and to the economy. The possession, use, and transfer of select agents are highly regulated and there is a greater emphasis on biosecurity. Typically, clinical laboratories are not required to register with the Select Agent Program.

Excluding the Select Agent regulations, there is no current federal requirement for the development of a biosecurity program and as such the recommendations presented here are advisory. However, hospital laboratories possess many highly infectious and potentially dangerous organisms and the application of these principles and the assessment process may enhance overall laboratory management.

Designing a biosecurity program that does not interfere with laboratory operations requires a familiarity with microbiology and the materials that require protection. Protecting pathogens and other sensitive biological materials while preserving the free exchange of research materials and information may present significant institutional challenges. Therefore, a tiered approach to protecting biological materials, commensurate with the identified risks, often provides the best resolution to conflicts that may arise. However, in the absence of legal requirements for a biosecurity program, the health and safety of laboratory personnel and the surrounding environment should take precedence over biosecurity concerns.



RISK MANAGEMENT

Risk analysis can be used to identify the need for a biosecurity program. A risk management approach to laboratory biosecurity can help establish if any agents would require biosecurity measures to prevent loss, theft, diversion, or intentional misuse and would help ensure that the protective measures provided, and the costs associated with that protection, are proportional to the risk.

The need for a biosecurity program should be based on the possible impact of the theft, loss, diversion, or intentional misuse of the materials, recognizing that different agents and toxins will pose different levels of risk. Risks need to be identified, prioritized and resources allocated based on that prioritization. Not all institutions will rank the same agent at the same risk level. Risk management methodology takes into consideration available institutional resources and the risk tolerance of the institution.

EXAMPLE GUIDANCE: A BIOSECURITY RISK ASSESSMENT AND MANAGEMENT PROCESS

Different models exist regarding biosecurity risk assessment. Most models share common components such as asset identification, threat, vulnerability and mitigation. What follows is one example of how a biosecurity risk assessment may be conducted. In this example, the entire risk assessment and risk management process may be divided into five main steps, each of which can be further subdivided:

1. Identify, inventory, and prioritize assets.
2. Assess potential threats and vulnerabilities.
3. Analyze the risk of specific security scenarios.
4. Design and develop an overall risk management program.
5. Regularly evaluate the institution's risk posture and protection objectives.

Example guidance for these five steps is provided below.

STEP 1: IDENTIFY, INVENTORY AND PRIORITIZE ASSETS:

- Identify the biological materials that exist at the institution, form of the material, location and quantities, including non-replicating materials (i.e., toxins).
- Familiarize yourself with the Select Agent list and verify that you do not have any stored in your lab. Contact your State Public Health Laboratory for guidance if you believe you have any.
- Identify sensitive information, equipment, personnel, and other materials that are important.
- Evaluate the potential for misuse of these biologic materials and other assets.
- Evaluate the consequences of misuse of these biologic materials and other assets.
- Prioritize the biologic materials and other assets based on the consequences of misuse (i.e., risk of malicious use).

At this point, an institution may find that none of its biologic materials and other assets merit the development and implementation of a separate biosecurity program or that the existing security at the facility is adequate. In this event, no additional steps would need to be completed.



STEP 2: ASSESS POTENTIAL THREATS AND VULNERABILITIES:

- Determine how undesired events might occur.
- Determine how unauthorized access might occur.
 - Identify the types of “Insiders” who may pose a threat to the biologic materials at the institution.
 - Identify the types of “Outsiders” (if any) who may pose a threat to the biologic materials at the institution.
 - Evaluate the motive, means, and opportunity of these various potential adversaries.
- Identify protective measures in place and how they could be breached (e.g., vulnerabilities).

STEP 3: ANALYZE THE RISK OF SPECIFIC SECURITY SCENARIOS:

- Develop a list of possible biosecurity scenarios, or undesired events that could occur at the institution (each scenario is a combination of an agent, an adversary, and an action). Consider:
 - Access to the agent within your laboratory.
 - How the undesired event could occur.
 - Protective measures already in place to prevent the occurrence.
 - How the existing protection measures could be breached.
- Evaluate the probability of each scenario materializing (e.g., the likelihood) and its associated consequences. Assumptions include:
 - A wide range of threats are possible, but certain threats are more probable than others.
 - All agents/assets are not equally attractive to an adversary.
 - Valid and credible threats, existing precautions, and the potential need for select enhanced precautions are considered.
- Prioritize or rank the scenarios by risk for review by management.

STEP 4: DEVELOP AN OVERALL RISK MANAGEMENT PROGRAM:

- Management commits to oversight, implementation, training and maintenance of the biosecurity program.
- Management develops a biosecurity risk statement, documenting which biosecurity scenarios represent an unacceptable risk and must be mitigated versus those risks appropriately handled through existing protection controls.
- Management develops a biosecurity plan to describe how the institution will mitigate those unacceptable risks including:
 - A written security plan, standard operating procedures, and incident response plans.
 - Written protocols for employee training on potential hazards, the biosecurity program and incident response plans.
- Management ensures necessary resources to achieve the protection measures documented in the biosecurity plan.
- Management assures the daily implementation, training and annual re-evaluation of the security program.

STEP 5: RE-EVALUATE THE INSTITUTION'S RISK POSTURE AND PROTECTION OBJECTIVES:

- Management regularly reevaluates and makes necessary modifications to the:
 - Biosecurity risk statement.
 - Biosecurity risk assessment process.
 - The institution's biosecurity program/plan.
 - The institution's biosecurity systems.
- Management re-evaluates the plan and documents how to address the issues:
 - At least annually
 - Routine review
 - After any biosecurity-related incident
 - After plan audits
 - After drills/exercises

DEVELOPING A BIOSECURITY PROGRAM

Management, researchers and laboratory supervisors must be committed to being responsible stewards of infectious agents and toxins. Development of a biosecurity program should be a collaborative process involving all stakeholders. The stakeholders include staff who work in the laboratory as well as staff who are associated with laboratory operations. The involvement of organizations and/or personnel responsible for a facility's overall security is critical because many potential biosecurity measures may already be in place as part of an existing safety or security program. This coordinated approach is critical in ensuring that the biosecurity program provides reasonable, timely and cost-effective solutions to address the identified security risks without unduly affecting the scientific or business enterprise or the provision of clinical and/or diagnostic services.

The need for a biosecurity program should reflect sound risk management practices based on a site-specific risk assessment. A biosecurity risk assessment should analyze the probability and consequences of loss, theft and potential misuse of pathogens and toxins. Most importantly, the biosecurity risk assessment should be used as the basis for making risk management decisions.

ELEMENTS OF A BIOSECURITY PROGRAM

After you perform a risk assessment for your facility you may determine that your current safety and security programs provide adequate security. This section offers examples and suggestions for components of a biosecurity program should the risk assessment reveal that further protections may be warranted. Program components should be site-specific and based upon an organizational threat/vulnerability assessment. Elements discussed below should be implemented, as needed, based upon the risk assessment process. They should not be construed as "minimum requirements" or "minimum standards" for a biosecurity program.

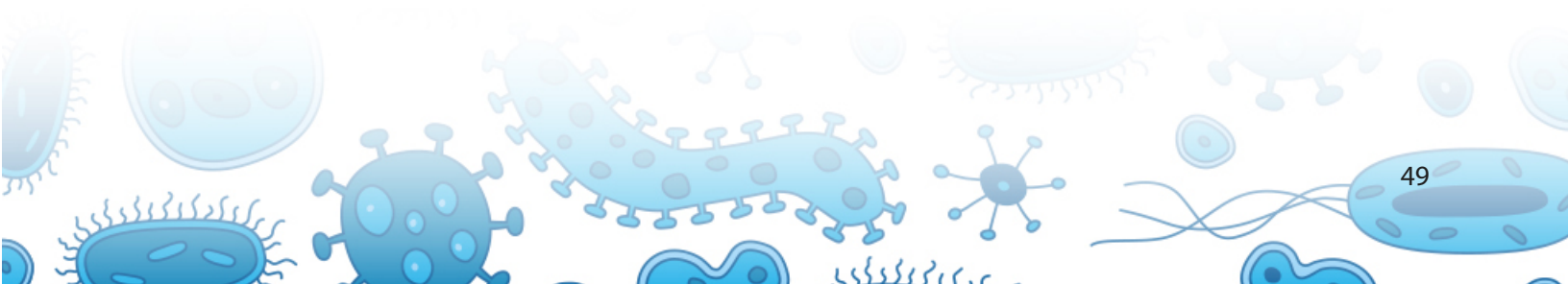

Program Management

If a biosecurity plan is implemented, institutional management must support it. Appropriate authority must be delegated for implementation and the necessary resources provided to assure program goals are being met. An organizational structure for the biosecurity program that clearly defines the chain of command, roles, and responsibilities should be distributed to the staff. Program management should ensure that biosecurity plans are created, exercised, and revised as needed. The biosecurity program should be integrated into relevant institutional policies and plans.

Physical Security—Access Control and Monitoring

The physical security elements of a laboratory biosecurity program are intended to prevent the removal of assets for non-official purposes. An evaluation of the physical security measures should include a thorough review of the building and premises, the laboratories, and biological material storage areas. Many of the requirements for a biosecurity plan may already exist in a facility's overall security plan.

Access should be limited to authorized and designated employees based on the need to enter sensitive areas. Methods for limiting access could be as simple as locking doors or having a key card system in place. Evaluations of the levels of access should consider all facets of the laboratory's operations and programs (e.g., laboratory entrance requirements, freezer access). The need for entry by visitors, laboratory workers, management officials, students, cleaning/maintenance staff, and emergency response personnel should be considered.

Personnel Management

Personnel management includes identifying the roles and responsibilities for employees who handle, use, store and transport dangerous pathogens and/or other important assets. The effectiveness of a biosecurity program against identified threats depends, first and foremost, on the integrity of those individuals who have access to pathogens, toxins, sensitive information and/or other assets. Employee screening policies and procedures are used to help evaluate these individuals. Policies should be developed for personnel and visitor identification, visitor management, access procedures, and reporting of security incidents.

Inventory and Accountability

Material accountability procedures should be established to track the inventory, storage, use, transfer and destruction of dangerous biological materials and assets when no longer needed. The objective is to know what agents exist at a facility, where they are located, and who is responsible for them. To achieve this, management should define: 1) the materials (or forms of materials) subject to accountability measures; 2) records to be maintained, update intervals and timelines for record maintenance; 3) operating procedures associated with inventory maintenance (e.g., how material is identified, where it can be used and stored); and 4) documentation and reporting requirements.

It is important to emphasize that microbiological agents are capable of replication and are often cultivated to accommodate the nature of the work involving their use. Therefore, knowing the exact "working" quantity of organisms at any given time may be impractical. Depending on the risks associated with a pathogen or toxin,



management can designate an individual who is accountable, knowledgeable about the materials in use, and responsible for security of the materials under his or her control.

Information Security

Policies should be established for handling sensitive information associated with the biosecurity program. For the purpose of these policies, “sensitive information” is that which is related to the security of pathogens and toxins, or other critical infrastructure information. Examples of sensitive information may include facility security plans, access control codes, agent inventories and storage locations. Discussion of information security in this section does not pertain to information which has been designated “classified” by the United States pursuant to Executive Order 12958, as amended, and is governed by United States law or to research-related information which is typically unregulated or unrestricted through the peer review and approval processes.

The objective of an information security program is to protect information from unauthorized release and ensure that the appropriate level of confidentiality is preserved. Facilities should develop policies that govern the identification, marking and handling of sensitive information. The information security program should be tailored to meet the needs of the business environment, support the mission of the organization, and mitigate the identified threats. It is critical that access to sensitive information be controlled. Policies for properly identifying and securing sensitive information including electronic files and removable electronic media (e.g., CDs, computer drives) should be developed.

Transport of Biological Agents

Material transport policies should include accountability measures for the movement of materials within an institution (e.g., between laboratories, during shipping and receiving activities) and outside of the facility (e.g., between institutions or locations). Transport policies should address the need for appropriate documentation and material accountability and control procedures for pathogens in transit between locations. Transport security measures should be instituted to ensure that appropriate authorizations have been received and that adequate communication between facilities has occurred before, during, and after transport of pathogens or other potentially hazardous biological materials. Personnel should be adequately trained and familiar with regulatory and institutional procedures for proper containment, packaging, labeling, documentation and transport of biological materials.

Accident, Injury and Incident Response Plans

Laboratory security policies should consider situations that may require emergency responders or public safety personnel to enter the facility in response to an accident, injury or other safety issue or security threat. The preservation of human life, the safety and health of laboratory employees and the surrounding community must take precedence in an emergency over biosecurity concerns. Facilities are encouraged to coordinate with medical, fire, police and other emergency officials when preparing emergency and security breach response plans. Standard Operation Procedures (SOPs) should be developed that minimize the potential exposure of responding personnel to potentially hazardous biological materials. Laboratory emergency response plans should be integrated with relevant facility-wide or site-specific security plans.

These plans should also consider such adverse events as bomb threats, natural disasters and severe weather, power outages, and other facility emergencies that may introduce security threats.

Reporting and Communication

Communication is an important aspect of a biosecurity program. A “chain of notification” should be established in advance of an actual event. This communication chain should include laboratory and program officials, institution management, and any relevant regulatory or public authorities. The roles and responsibilities of all involved officials and programs should be clearly defined. Policies should address the reporting and investigation of potential security breaches (e.g., missing biological agents, unusual or threatening phone calls, unauthorized personnel in restricted areas).

Training and Practice Drills

Biosecurity training is essential for the successful implementation of a biosecurity program. Program management should establish training programs that inform and educate individuals regarding their responsibilities within the laboratory and the institution. Practice drills should address a variety of scenarios such as loss or theft of materials, emergency response to accidents and injuries, incident reporting, and identification of and response to security breaches. These scenarios may be incorporated into existing emergency response drills such as fire drills or building evacuation drills associated with bomb threats. Incorporating biosecurity measures into existing procedures and response plans provides efficient use of resources saves time and can minimize confusion during emergencies.

Security Updates and Re-evaluations

The biosecurity risk assessment and program should be reviewed and updated routinely and following any biosecurity-related incident. Reevaluation is a necessary and on-going process in the dynamic environments of today’s biomedical and research laboratories. Biosecurity program managers should develop and conduct biosecurity program audits and implement corrective actions as needed. Audit results and corrective actions should be documented. The appropriate program officials should maintain records.

Select Agents

Most clinical laboratories will rarely, if ever, have a select agent tested in their lab. Those who do will only handle a select agent temporarily while testing a patient sample. If you’re unable rule out the possibility that the sample may be a select agent and must refer an isolate to your LRN reference laboratory for confirmation, then during the interim period you must take the necessary biosecurity precautions while in possession of that sample. Confirmation of a select agent will require that you work with your LRN reference laboratory to properly transfer or destroy the sample and file the proper documentation with the CDC.

If your laboratory purposely possesses, uses or transfers select agents, it must register with the Select Agent program and comply with all biosecurity requirements of the National Select Agent Program. CDC and USDA Select Agent Programs (42 CFR Part 73; 7 CFR 331 and 9 CFR 121).



REFERENCES

1. Richmond, JY, Nesby-O'Dell, SL. Laboratory security and emergency response guidance for laboratories working with select agents. *MMWR Recomm Rep*. 2002;51:(RR-19):1-6.
2. Laboratory biosafety manual. 3rd ed. Geneva: World Health Organization; 2004.
3. American Biological Safety Association. ABSA biosecurity task force white paper: understanding biosecurity. Illinois: The Association; 2003.
4. Possession, use and transfer of select agents and toxins, 42 CFR Part 73 (2012).
5. Possession, use and transfer of biological agents and toxins, 7 CFR Part 331 (2012).
6. Possession, use and transfer of biological agents and toxins, 9 CFR Part 121 (2012).
7. Casadevall A, Pirofski L. The weapon potential of a microbe. Bethesda, The National Institutes of Health; 2005.
8. McIntosh IBD, Morgan CB, Dorgan CE. ASHRAE laboratory design guide. Atlanta: American Society of Heating, Refrigerating and Air-Conditioning Engineers, Inc; 2001.
9. U.S. Department of Labor. Occupational exposure to bloodborne pathogens. Final Rule. 29 CFR 1910.1030 (1991).
10. Richmond JY. HIV biosafety: guidelines and regulations. In: Schochetman G, George JR, editors. *AIDS testing*. 2nd ed. New York: Springer-Verlag; 1994. p. 346-60.
11. Centers for Disease Control and Prevention. Update: universal precautions for prevention of transmission of human immunodeficiency virus, hepatitis B virus and other bloodborne pathogens in health-care settings. *MMWR Morb Mortal Wkly Rep*. 1988;37:377-82,387-8.
12. Garner JS. Guideline for isolation precautions in hospitals. *Infect Control Hosp Epidemiol*. 1996;17:53-80.
13. National Committee for Clinical Laboratory Standards. Protection of laboratory workers from occupationally-acquired infections; approved guideline, 3rd ed. * In 1996 the United States Hospital Infection Control Practices Advisory Committee introduced a new set of guidelines, "Standard Precautions," to synthesize the major features of Universal Precautions (blood and body fluid) with Body Substance Isolation Precautions (designed to reduce the risk of transmission of pathogens from moist body substances). Standard Precautions apply to 1) blood; 2) all body fluids, secretions, and excretions except sweat, regardless of whether or not they contain visible blood; 3) non-intact skin; and 4) mucous membranes. For additional information on Standard Precautions, see reference 6 or the CDC Web site: www.cdc.gov.

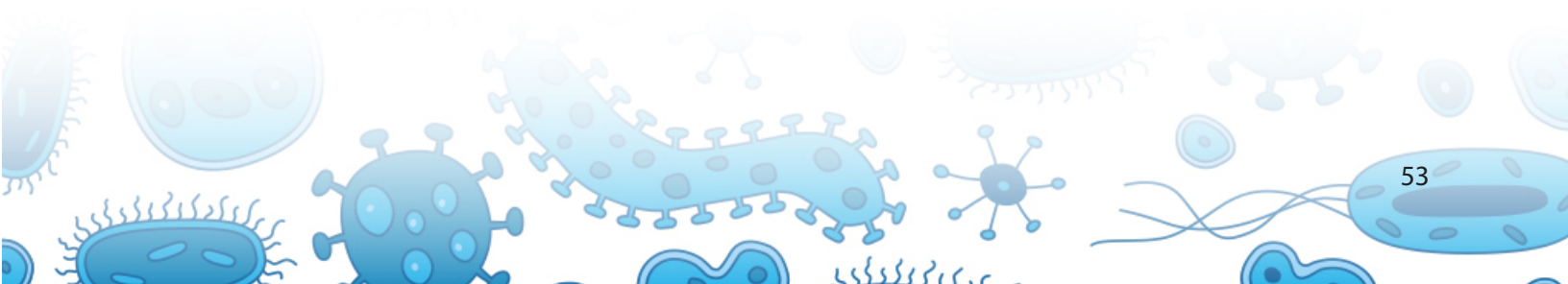

CHAIN-OF-CUSTODY GUIDANCE FOR CLINICAL LABORATORIES

Chain-of-custody is legally defined as a process that documents the movement and location of physical evidence from the time it is obtained until the time it is presented in court. One common use of chain-of-custody in a clinical laboratory centers on sample collection for drug screening. This usually requires the completion of a form which is submitted in a sealed package along with the sample for testing. Beyond this use, most clinical laboratorians are not involved with the concepts of providing a chain-of-custody.

DATE APPROVED:

8 / 1 / 2016

It's important for clinical laboratories to be familiar with the concepts of this process, but it's not necessary for them to have special chain-of-custody forms. Any sample submitted to a clinical laboratory has the potential of being a bioterrorism agent; however, it's not practical to start a chain-of-custody form for each specimen. The need for chain-of-custody documentation will be determined after a confirmed identification of the agent, which may be several days after collection.

Clinical laboratories have always had strict practices to accurately document their actions. These practices complement the main concepts of chain-of-custody which are to provide an accurate accounting of how evidence was acquired, maintained, transported and examined including by whom, when, where, and for what purpose.

In the event that a potential bioterrorism agent or a suspect select agent is identified in a clinical laboratory, the first step is to contact the local LRN Reference Laboratory. Once the LRN Reference Laboratory has possession, they may initiate their own internal chain-of-custody. The LRN Reference Laboratory will then complete confirmation testing on the suspect sample.

Representatives from the LRN Reference Laboratory will provide specific guidance regarding chain-of-custody documentation based on the severity of the event. They will be able to assist the clinical laboratory to retrospectively fill in the time line from sample collection to the transfer of custody to the LRN Reference Laboratory. Examples of what a clinical laboratory may be asked to provide are:

- Copies of the initial order written by the attending physician.
- Copies of laboratory requisitions.
- Print out from the laboratory information management system (LIMS).
- Copies of work cards.
- Copies of laboratory reports.

This list is not all inclusive. There are other pieces of information that may be necessary to complete the chain from collection to transfer.

The chance of a clinical laboratory having to provide documentation for a chain-of-custody is very rare. Clinical laboratories are encouraged NOT to write chain-of-custody policies. There is no law, code, regulation, or other legal formula which gives specific guidance regarding the creation or use of chain-of-custody in a clinical laboratory setting. Records like those listed in this document will support a person's testimony on how evidence was handled. If there is a written chain-of-custody plan then any non-compliance with the internal written plan would challenge the integrity of the evidence. Contacting the local LRN reference laboratory to seek specific guidance is the best practice a clinical laboratory could follow to start the first link in a chain-of-custody.

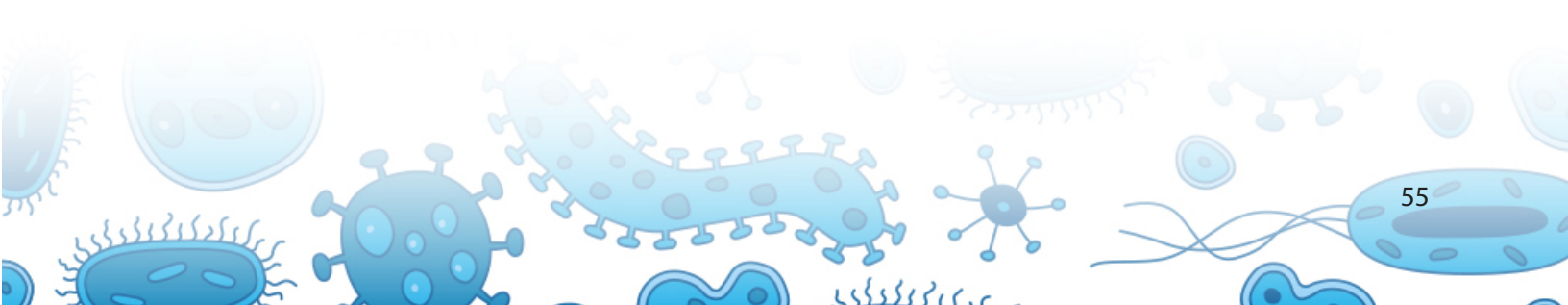

REGULATIONS THAT IMPACT CLINICAL LABORATORIES

SELECT AGENT REGULATIONS

The possession, use and transfer of select agents and toxins are regulated by the United States Department of Health and Human Services (HHS) and the United States Department of Agriculture (USDA). Clinical and diagnostic laboratories that possess, use, or transfer a select agent or toxin in a diagnostic specimen that is presented for diagnosis or verification will be exempt from the regulations as long as the following conditions are met: (42 CFR 73.5 and 73.6)

DATE APPROVED:

8 / 1 / 2016

1. Within 7 calendar days **after confirmation**, the select agent or toxin must be transferred in accordance with § 73.16 or destroyed on-site by a recognized sterilization or inactivation process. For further information, see Decontamination of Select Agents Isolated in the Clinical Laboratory in the appendix.
2. The select agent or toxin must be secured against theft, loss, or release during the period between identification and transfer or destruction. Any theft, loss, or release of such agent or toxin must be reported.
3. The identification of the select agent or toxin is reported to the CDC or APHIS (Your LRN reference laboratory will work with you to complete the [APHIS/CDC Form 4: "Report of the Identification of a Select Agent or Toxin"](#)
 - a. APHIS/CDC Form 4 must be submitted within 7 **calendar** days.
 - b. A copy of APHIS/CDC Form 4 must be kept for **3** years.

APHIS/CDC FORMS

1. APHIS/CDC Form 1 – [Application for Registration for Possession, Use, and Transfer of Select Agents and Toxins](#). (This does not apply to clinical laboratories unless they intend to obtain and use regulated select agents and toxins).
2. APHIS/CDC Form 2 – [Request to Transfer Select Agents and Toxins](#). This is used for transfer of confirmed select agents.
3. APHIS/CDC Form 3 – [Report of Theft, Loss or Release of Select Agents or Toxins](#). This incident form is used to report potential theft, loss, release, or occupational exposure. Note: an occupational exposure is considered to be a release of a select agent or toxin outside of the primary containment barrier such as a BSC. The Handling of a sample or isolate on the open bench is classified as a release of the select agent.
4. APHIS/CDC Form 4 – [Report of the Identification of a Select Agent or Toxin](#) from clinical/diagnostic specimen, proficiency testing, or seizure by federal law enforcement.
5. APHIS/CDC Form 5 – [Request for Exemption of Select Agents and Toxins for an Investigational Product](#)
6. For assistance in filling out Forms 2, 3, and 4 refer to the following job aids:
 - a. [Form 2: APHIS/CDC Select Agent Form 2 Checklist](#)
 - b. [Form 3: APHIS/CDC Select Agent Form 3 Checklist](#)

c. [Form 4: APHIS/CDC Select Agent Form 4 Checklist](#)

The APHIS/CDC forms and guidance documents may be found on the Federal Select Agent Program website: <http://www.selectagents.gov/forms.html>. Contact your LRN reference laboratory with any questions.

WHAT TO DO IF YOU SUSPECT OR HAVE A CONFIRMED IDENTIFICATION OF A SELECT AGENT

Refer to the [Select Agent Algorithm Guide](#) for the process to be followed.

If you suspect you have a select agent refer to the job aid: [Suspected Select Agent Checklist](#).

If a clinical lab decides to destroy the patient specimens and cultures, inactivation using an on-site autoclave or chemical decontamination must be performed before transport to a medical waste contractor for destruction and disposal. See the Decontamination of Select Agents Isolated in the Clinical Laboratory document for instructions.

OSHA BLOODBORNE PATHOGENS REGULATIONS

Clinical laboratory workers are routinely exposed to bloodborne pathogens that are present in human blood and can cause disease in humans. These pathogens include, but are not limited to, hepatitis B virus (HBV) and human immunodeficiency virus (HIV). The following are the OSHA regulatory standards for the implementation of a bloodborne pathogens exposure control program by laboratory management for the safety of its employees.

- **OSHA BLOODBORNE PATHOGENS STANDARD**

- As mandated by the Needlestick Safety and Prevention Act, OSHA revised the Bloodborne Pathogens Standard (*29 CFR 1910.1030*), effective April 18, 2001. Definitions for bloodborne pathogens, other potentially infectious materials (OPIM), and occupational exposure are found in *29 CFR 1910.1030(b)*.
- Healthcare entities must identify employees who have occupational exposure to blood or OPIM, establish, and implement a written Exposure Control Plan (ECP) that is designed to eliminate or minimize employee exposures. *29 CFR 1910.1030(c)(1)*

- **POST-EXPOSURE FOLLOW-UP**

- Employer should ensure that a post-exposure evaluation and follow-up is in place to handle needlestick and sharps injuries.
- Employer should provide a confidential medical evaluation and follow-up to the exposed employee, immediately following the report of an exposure incident (*29 CFR 1910.1030(f)(3)*). It is recommended that the follow-up include identifying injury patterns and accident analysis to determine if additional training, procedures, or safer needle devices should be used to prevent future accidents.

- **RECORDKEEPING FOR BLOODBORNE PATHOGENS**

- Employers should establish and maintain both medical and training records (*29 CFR 1910.1030(h)(1) and 29 CFR 1910.1020*).
- If an exposure occurs, the employer should add documentation to the medical record to include incident description, test results, follow up instructions and written evaluation from the health care professional.

- **NEEDLESTICK AND OTHER SHARPS INJURIES**

- Utilize safer needle devices and needleless devices to decrease needlestick or other sharps exposures.
- Exercise proper handling and disposal of needles and other sharps according to the Bloodborne Pathogens Standard can help prevent needlestick injuries.
- Implement engineering and work practice controls to help prevent exposures

- **UNIVERSAL PRECAUTIONS**

- Employers should define and implement universal precautions. (*29 CFR 1910.1030(d)(1)*).
- All blood and other potentially infectious materials should be handled with appropriate precautions.
- Gloves, masks, and gowns should be worn if blood or OPIM exposure is anticipated.
- Engineering and work practice controls should be in place to limit exposure.

- **PERSONAL PROTECTIVE EQUIPMENT (PPE)**

- PPE is required by the Bloodborne Pathogens Standard after institution of engineering and work practice controls and if exposure to blood and OPIM is anticipated and where occupational exposure remains. *29 CFR 1910.1030(d)(2)(i)*
- Wear gloves when hand contact with blood, mucous membranes, OPIM, or non-intact skin is anticipated, and when performing vascular access procedures, or when handling contaminated items or surfaces. *29 CFR 1910.1030(d)(3)(ix)*
- Employers must ensure that employees wash hands and any other exposed skin with soap and water or flush mucous membranes with water immediately after contact with blood or other potentially infectious materials (OPIM). *29 CFR 1910.1030(d)(2)(vi)*
- Employers must ensure that hand washing facilities are immediately accessible to personnel. *29 CFR 1910.1030(d)(2)(iii)*
- Protective clothing must be removed before leaving the work area (*29 CFR 1910.1030(d)(3)(vii)*), and disposed of in an appropriately designated area or container for storage, washing, decontamination, or disposal. *29 CFR 1910.1030(d)(3)(viii)*



- **LATEX ALLERGY**

- Employers must provide appropriate gloves when exposure to blood or other potentially infectious materials (OPIM) exists. *29 CFR 1910.1030*
- Latex free glove alternatives shall be readily accessible to those employees who are allergic to the gloves that are normally provided. *CFR 1910.1030(d)(3)(iii)*

- **BLOODBORNE ILLNESSES - HEPATITIS B VIRUS**

- Employers should implement an effective exposure control plan (*29 CFR 1910.1030(c)(1)*) to prevent exposure.
- Employers must offer all employees who have occupational exposure to blood or OPIM, under the supervision of a licensed physician, the hepatitis B vaccination (*29 CFR 1910.1030(f)(2)*):
- Except as provided in *29 CFR 1910.1030(f)(2)(i)*.
- At no cost to employee, at a reasonable time and place (*29 CFR 1910.1030(f)(2)(i)*).
- After the employees has received the required training
- (*29 CFR 1910.1030(f)(1)*)and
- Within 10 working days of initial assignment
- Those declining the hepatitis B vaccine must sign a declination statement. (*29 CFR 1910.1030 Appendix A*).
- OSHA provides the following non-mandatory sample form: Health Care Professionals Written Opinion for Hepatitis B Vaccination.
- Employers should offer testing for antibodies to the hepatitis B surface antigen one to two months after the completion of the three-dose vaccination series.
- Employees who do not respond to the primary vaccination series must be offered a second three-dose vaccine series and retesting. Non-responders must be offered medical evaluation. *29 CFR 1910.1030(f)(1)(ii)(D)*
- Employees must be offered a timely post-exposure follow-up with hepatitis B immune globulin and initiation of the hepatitis B vaccine. *29 CFR 1910.1030(f)(1)(ii)(D)*
- A healthcare professional's written opinion is required after an exposure incident. *29 CFR 1910.1030(f)(5)(ii)*
- OSHA provides the following non-mandatory sample form: Written Opinion for Post-Exposure Evaluation.
- Employers should immediately make a confidential medical evaluation and follow-up available following a report of an exposure incident. *29 CFR 1910.1030(f)(3)*
- Employers must maintain a log of injuries from contaminated sharps. *29 CFR 1910.1030(h)(5)*

- **BLOODBORNE ILLNESSES - HUMAN IMMUNODEFICIENCY VIRUS (HIV)**

- Employers should implement an effective exposure control plan to prevent exposures. *29 CFR 1910.1030(c)(1)*
- Employers must, under certain circumstances, provide post-exposure prophylaxis for HIV to healthcare workers who have an exposure incident. *29 CFR 1910.1030(b)*

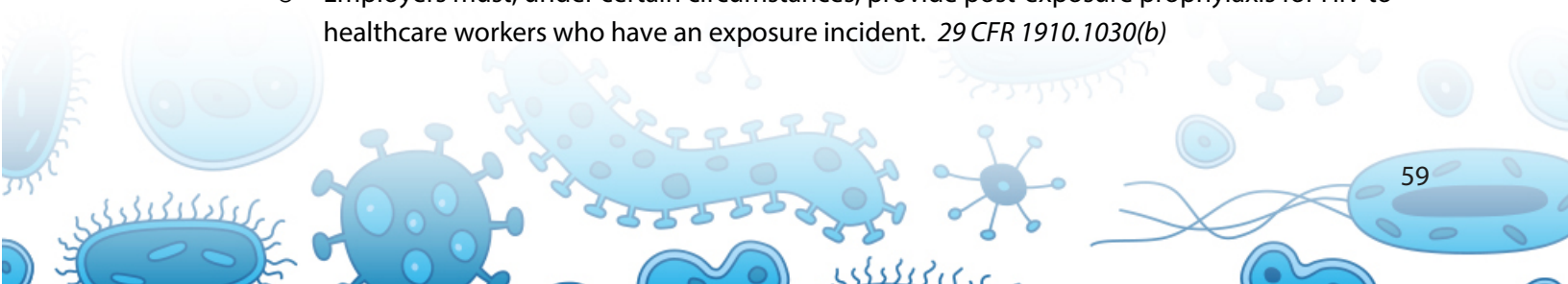

- Employers must offer employees, who have an incident, a confidential medical evaluation and follow-up. *29 CFR 1910.1030(f)(3)*
 - A healthcare professional's written opinion is required after an exposure incident. *29 CFR 1910.1030(f)(5)(ii)*
 - A non-mandatory OSHA sample form is available: Written Opinion for Post-Exposure Evaluation.
 - Employers must maintain a log of injuries from contaminated sharps. *29 CFR 1910.1030(h)*
- **BLOODBORNE ILLNESSES - HEPATITIS C VIRUS (HCV)**
 - Employer should implement an effective exposure control plan to prevent exposure. *29 CFR 1910.1030(c)(1)*
 - Employer must offer employees who have an incident a confidential medical evaluation and follow-up. *29 CFR 1910.1030(f)(3)*
 - A healthcare professional's written opinion is required after an exposure incident. *29 CFR 1910.1030(f)(5)(ii)*
 - A non-mandatory OSHA sample form is available: Written Opinion for Post-Exposure Evaluation.
 - Immunoglobulin or antiviral therapy is not recommended and no effective post-exposure prophylaxis is known at this time (Centers for Disease Control and Prevention (CDC), 1998).
- **LABELS AND SIGNS**
 - **Biohazardous Waste Containers** – Regulated waste (e.g. I.V. tubing used to administer blood, contaminated PPE, needles, etc.) must be disposed of into appropriately labeled biohazardous waste containers. *29 CFR 1910.1030(g)(1)(i)(A)*
 - **Biohazard Labels** – Containers that contain regulated waste (contaminated PPE, needles, etc.) as well as refrigerators and freezers containing blood or OPIM, must bear the biohazard symbol. *29 CFR 1910.1030(g)(1)(i)(A)*
 - Labels should be fluorescent orange or orange-red, with lettering and symbols in a contrasting color. *29 CFR 1910.1030(g)(1)(i)(C)*
 - Red bags or red containers may be substituted for labels. *29 CFR 1910.1030(g)(1)(i)(E)*
 - **Exception for Blood Products** – Individual containers of blood, blood components or products that are labeled as to their contents and have been released for transfusion or other clinical use need not be labeled as hazardous. *29 CFR 1910.1030(g)(1)(i)(F)*
 - **Individual containers of blood or OPIM** – need not be labeled if placed in a labeled container for storage, transport, shipment or disposal. *29 CFR 1910.1030(g)(1)(i)(G)*

OSHA website - <https://www.osha.gov/law-regs.html>

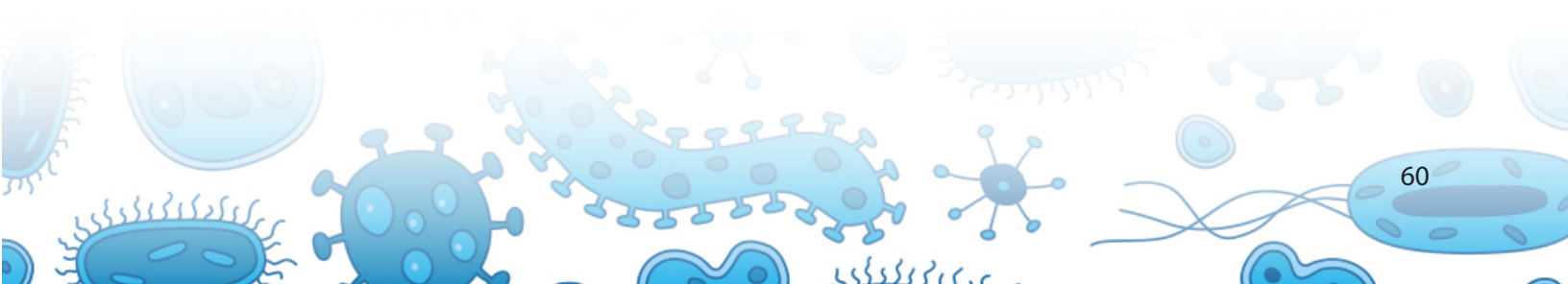

CLINICAL LABORATORY IMPROVEMENT ACT (CLIA)

Diagnostic tests help health care providers to identify specific diseases or to monitor various health conditions. The Clinical Laboratory Improvement Amendments of 1988 (CLIA) are federal regulations ([Standards and Certification: Laboratory Requirements \(42 CFR 493\)](#)) that govern laboratory testing. Government authority has been given to the Center for Medicare and Medicaid Services (CMS) to administer the CLIA program. The CLIA 1988 amendments ensure the quality of laboratory performance and require clinical laboratories to be certified or accredited by CLIA or one of seven approved private, non-profit accrediting agencies approved by CMS. Adherence to the CLIA federal regulations must be established prior to accepting human samples for diagnostic testing. Laboratories can obtain multiple types of CLIA certificates, based on the type of diagnostic tests performed. Although all clinical laboratories must be properly certified to receive Medicare or Medicaid payments, CLIA has no direct Medicare or Medicaid program responsibilities.

Three federal agencies are responsible for CLIA: The Food and Drug Administration (FDA), Center for Medicare and Medicaid Services (CMS) and the Center for Disease Control (CDC). Each agency has a unique role in assuring quality laboratory testing.

FDA

- Categorizes tests based on complexity
- Reviews requests for Waiver by Application
- Develops rules/guidance for CLIA complexity categorization

CMS

- Issues laboratory certificates
- Collects user fees
- Conducts inspections and enforces regulatory compliance
- Approves private accreditation organizations for performing inspections, and approves state exemptions
- Monitors laboratory performance on Proficiency Testing (PT) and approves PT programs
- Publishes CLIA rules and regulations

CDC

- Provides analysis, research, and technical assistance
- Develops technical standards and laboratory practice guidelines, including standards and guidelines for cytology
- Conducts laboratory quality improvement studies
- Monitors proficiency testing practices
- Develops and distributes professional information and educational resources
- Manages the Clinical Laboratory Improvement Advisory Committee (CLIAC)

For more information: <http://www.cms.gov/Regulations-and-Guidance/Legislation/CLIA/index.html>.

AGENTS

Quick Reference Guide to Specimen Collection of Suspected Agents of Bioterrorism & Emerging Infectious Diseases.....	63
Quick Reference Guide to Specimen Collection of Unknown Virus.....	69
Quick Reference Guide to Specimen Collection for Botulism	71
Quick Reference Guide to Specimen Collection for Staphylococcal Enterotoxin B	73
<i>Bacillus anthracis</i> (ANTHRAX).....	75
<i>Bacillus anthracis</i> Identification Flowchart	82
<i>Brucella</i> spp. (<i>B. abortus</i> , <i>B. canis</i> , <i>B. melitensis</i> , and <i>B. suis</i>) (BRUCELLOSIS)	85
<i>Brucella</i> Identification Flowchart	102
<i>Burkholderia mallei</i> (GLANDERS)	108
<i>Burkholderia mallei</i> Identification Flowchart	115
<i>Burkholderia pseudomallei</i> (MELIOIDOSIS).....	118
<i>Burkholderia pseudomallei</i> Identification Flowchart	126
<i>Francisella tularensis</i> (TULAREMIA)	129
<i>Francisella tularensis</i> Identification Flowchart.....	137
<i>Yersinia pestis</i> (PLAGUE).....	140
<i>Yersinia pestis</i> Identification Flowchart.....	152
AlphaViruses.....	156
Botulinum Toxin (BoNT) <i>Clostridium botulinum</i>	160
<i>Coxiella burnetii</i> (Q FEVER)	164
Orthopox viruses (SMALLPOX)	169
<i>Ricinus communis</i> (RICININE).....	173
Staphylococcal Enterotoxin B (SEB) <i>Staphylococcus aureus</i>	177
Viral Hemorrhagic Fevers (VHF).....	180



QUICK REFERENCE GUIDE TO SPECIMEN COLLECTION OF SUSPECTED AGENTS OF BIOTERRORISM & EMERGING INFECTIOUS DISEASES

All potential agents, if not ruled out must be referred to your local LRN Reference Laboratory or your public health laboratory - including original specimen and all isolates.

Abbreviations: Δ, delayed entry depends on instrument; A, autopsy; BAP, blood agar plate; BCYE, buffered charcoal-yeast extract agar; C, Celsius; CHOC, chocolate agar; CNA, colistin-nalidixic acid agar; g, grams; h, hours; MAC, MacConkey agar; PEA, phenylethyl alcohol blood agar; RT, room temperature, cc, cubic centimeter (mL)

DISEASE/ AGENT	SPECIMEN SELECTION		Time & Temp		SPECIMEN PLATING AND PROCESSING				
			Transport	Storage	BAP	CHOC	MAC	Stain	Other
Anthrax (<i>Bacillus anthracis</i>)	Cutaneous	Vesicular Stage: collect fluid from intact vesicles on sterile swab(s). The organism is best demonstrated in this stage.	≤2 h RT	≤24 h RT	X	X	X	Gram Stain	India Ink and slide motility NOT recommended due to safety considerations
		Eschar Stage: without removing eschar, insert swab beneath the edge of eschar, rotate and collect lesion material.	≤2 h RT	≤24 h RT	X	X	X	Gram Stain	India Ink and slide motility NOT recommended due to safety considerations
	Gastro-Intestinal	Stool: collect 5-10 g in a clean, sterile, leakproof container.	≤1 h RT	≤24 h 4°C	Inoculate routine stool plating media plus CNA or PEA				Minimal Recovery
		Blood: collect per institution's procedure for routine blood cultures.	≤2 h RT	Incubate per lab protocol	Blood Culture Bottles				Positive in late stages of disease



DISEASE/ AGENT	SPECIMEN SELECTION		Time & Temp		SPECIMEN PLATING AND PROCESSING				
			Transport	Storage	BAP	CHOC	MAC	Stain	Other
	Inhalation	Sputum: collect expectorated specimen into a sterile, leakproof container.	≤2 h RT	≤24 h RT	X	X	X		Minimal Recovery
		Blood: collect per institution's procedure for routine blood cultures.	≤2 h RT	Incubate per lab protocol	Blood Culture Bottles				Positive in late stages of disease
Brucellosis (<i>Brucella</i> spp.)	Acute, Subacute or Chronic	Serum: collect 10-12 cc acute phase specimen as soon as possible after disease onset. Followed by a convalescent specimen, obtained 14-21 days	~2 h RT	-20°C	Specimen should be stored and shipped frozen @ -20°C				Serologic diagnosis: 1. Single titer: ≥ 1:160 2. 4-fold rise 3. IgM
		Blood: collect per institution's procedure for routine blood culture.	≤2 h RT	Incubate per lab protocol	Blood Culture Bottles			Gram Stain	Blood culture isolation rates vary from 15-70% depending on methods and length of incubation
		Bone Marrow: collect per institution's surgical/pathology procedure	≤15 min RT	≤24 h 4°C	X	X	X	Gram Stain	Inoculate to blood culture bottles or enrichment broth
					Hold cultures for at least 7 days				
Spleen or Liver: Submit in sterile container, May add 1-2 drops of saline to keep moist		≤24 h RT	X	X	X	Gram Stain			



DISEASE/ AGENT	SPECIMEN SELECTION		Time & Temp		SPECIMEN PLATING AND PROCESSING				
			Transport	Storage	BAP	CHOC	MAC	Stain	Other
Plague (<i>Yersinia pestis</i>)	Pneumonic	Sputum/throat: collect routine throat culture using a swab or expectorated sputum collected into a sterile, leakproof container.	≤2 h RT	≤24 h 4°C	X	X	X	Gram Stain	Minimal recovery.
		Bronchial/tracheal wash: collect per institution's procedure in an area dedicated to collecting respiratory specimens under isolation/ containment circumstances, i.e., isolation chamber/ "bubble".	≤2 h RT	≤24 h 4°C	X	X	X	Gram Stain	
		Blood: collect per institution's procedure for routine blood cultures.	≤2 h RT	Incubate per lab protocol	Blood Culture Bottles				Patients with negative cultures having a single titer, ≥1:10, specific to F1 antigen by agglutination would meet presumptive criteria
	Bubonic	Tissue or aspirate: Submit in sterile container, May add 1-2 drops of saline to keep moist	≤2 h RT	≤24 h 4°C	X	X	X	Gram Stain	



Abbreviations: Δ, delayed entry depends on instrument; A, autopsy; BAP, blood agar plate; BCYE, buffered charcoal-yeast extract agar; C, Celsius; CHOC, chocolate agar; CNA, colistin-nalidixic acid agar; g, grams; h, hours; MAC, MacConkey agar; PEA, phenylethyl alcohol blood agar; RT, room temperature, cc, cubic centimeter (mL)

DISEASE/ AGENT	SPECIMEN SELECTION		Time & Temp		SPECIMEN PLATING AND PROCESSING				
			Transport	Storage	BAP	CHOC	MAC	Stain	Other
Tularemia (<i>Francisella tularensis</i>)	Pneumoni c	Sputum/throat: collect routine throat culture using a swab or expectorated sputum collected into a sterile, leakproof container.	≤2 h RT	≤24 h 4°C	X	X	X	Gram Stain	Minimal recovery. Add BCYE plate
		Bronchial/tracheal wash: collect per institution's procedure in an area dedicated to collecting respiratory specimens under isolation/containment circumstances, i.e., isolation chamber/"bubble".	≤2 h RT	≤24 h 4°C	X	X	X	Gram Stain	Add BCYE plate
		Blood: collect per institution's procedure for routine blood cultures.	≤2 h RT	Incubate per lab protocol	Blood Culture Bottles			Gram Stain	Delayed entry may depend on instrument



DISEASE/ AGENT	SPECIMEN SELECTION		Time & Temp		SPECIMEN PLATING AND PROCESSING				
			Transport	Storage	BAP	CHOC	MAC	Stain	Other
		Biopsy, tissue, scrapings, aspirate or swab: Submit in sterile container. For small tissue samples add several drops of sterile normal saline to keep tissue moist. Swabs are collected by obtaining firm sample of advancing margin of the lesion. Place swab in transport package to keep swab moist with the transport medium inside packet.	≤2 h RT	≤24 h 4°C	X	X	X	Gram Stain	
Glanders & Meliodosis <i>(Burkholderia mallei & pseudomallei)</i>		Blood or Bone Marrow: collect using standard automated blood culture system per institution's procedure for routine blood culture.	≤2 h RT	Δ	Blood Culture Bottles			Gram Stain	Delayed entry may depend on instrument
		Sputum/Bronchial: collect into sterile leakproof container	≤2 h RT	≤24 h 4°C	X	X	X	Gram Stain	
		Abscess material and wounds: tissue aspirate, tissue fluid preferred to swab alternative	≤2 h RT	≤24 h 4°C	X	X	X	Gram Stain	
		Urine:	≤2 h RT	≤24 h 4°C	X	X	X	Gram Stain	



DISEASE/ AGENT	SPECIMEN SELECTION		Time & Temp		SPECIMEN PLATING AND PROCESSING				
			Transport	Storage	BAP	CHOC	MAC	Stain	Other
		<p>Serum: collect (≥ 1 mL) acute phase specimen as soon as possible after disease onset. Followed by a convalescent specimen, obtained 14-21 days. Specimens should be collected if serologic diagnosis is available in the United States.</p>			<p>Specimen should be stored and shipped frozen @ -20°C</p>				<p>Serologic diagnosis: 1. Single titer: $\geq 1:160$ 2. 4-fold rise 3. IgM</p>



QUICK REFERENCE GUIDE TO SPECIMEN COLLECTION OF UNKNOWN VIRUS

Abbreviations: Δ, delayed entry depends on instrument; A, autopsy; BAP, blood agar plate; BCYE, buffered charcoal-yeast extract agar; C, Celsius; CHOC, chocolate agar; CNA, colistin-nalidixic acid agar; g, grams; h, hours; MAC, MacConkey agar; PEA, phenylethyl alcohol blood agar; RT, room temperature, cc, cubic centimeter (mL)

DISEASE/ AGENT	SPECIMEN SELECTION		Time & Temp		SPECIMEN PLATING AND PROCESSING
			Transport	Storage	
Q fever (<i>Coxiella burnetii</i>)		Serum: Collect serum as soon as possible after onset of symptoms (acute) and with a follow up specimen (convalescent) at ≥ 14 days for serological testing.	≤ 2 h RT	≤ 4°C	Note: Sentinel laboratories should not accept environmental or animal samples: such specimens should be forwarded directly to your local LRN Reference Laboratory.
		Blood: Collect EDTA (lavender) or sodium citrate (blue) for PCR testing. If possible, collect specimens prior to antimicrobial therapy.	4°C	4°C	
		Tissue, Body Fluids and Other including cell culture & cell supernatants. Arrange for immediate shipment at 2-8 °C to an appropriate higher-level LRN laboratory.	≤ 24 h 2-8 °C	-70°C or on dry ice	
Smallpox (<i>Variola virus</i>)	Rash	Biopsy specimens: aseptically place two to four portions of tissue into a sterile, leakproof, freezable container.	~6 h 4°C	-20°C to -70°C	<ol style="list-style-type: none"> 1. A suspected case of smallpox should be reported immediately to the respective state health department for review 2. And if, after review, smallpox is still suspected, CDC's Poxvirus Section @ 404-639-2184 should be contacted for approval to send 3. At this time review the packaging/shipping requirements with CDC and request assistance in coordinating a carrier for transport/shipment
		Scabs: aseptically place scrapings/ material into a sterile, leakproof, freezable container.	~6 h 4°C	-20°C to -70°C	
		Vesicular fluid: collect fluid from separate lesions onto separate sterile swabs. Be sure to include cellular material from the base of each respective vesicle.	~6 h RT	-20°C to -70°C	

DISEASE/ AGENT	SPECIMEN SELECTION		Time & Temp		SPECIMEN PLATING AND PROCESSING
			Transport	Storage	
Viral Hemorrhagic Fever (VHF)		Serum: collect 10-12 cc of serum. Laboratory tests used to diagnose VHF include: antigen capture ELISA, IgG ELISA, PCR, and virus isolation.	~2 h RT	-20°C to -70°C	Specific handling conditions are currently under development.



QUICK REFERENCE GUIDE TO SPECIMEN COLLECTION FOR BOTULISM

Abbreviations: Δ, delayed entry depends on instrument; A, autopsy; BAP, blood agar plate; BCYE, buffered charcoal-yeast extract agar; C, Celsius; CHOC, chocolate agar; CNA, colistin-nalidixic acid agar; g, grams; h, hours; MAC, MacConkey agar; PEA, phenylethyl alcohol blood agar; RT, room temperature, cc, cubic centimeter (mL)

* Appropriate specimen

Disease/ Agent	Specimen Selection					Specimen Handling		Comments
Botulism (<i>Clostridium botulinum</i>)	Specimen Type	Clinical Syndrome				Specimen volume	Transport temp	Specimen(s) of choice for confirming botulism: a. Serum b. Wound/tissue c. Stool and incriminated food
		Foodborne	Infant	Wound	Intentional Release			
	Enema Fluid	X	X	X	X	20 cc	4 ° C	Purge with a minimal amount of sterile nonbacteriostatic water to minimize dilution of toxin
	Food Sample	X	X		X	10-50 g	4 ° C	Foods that support <i>C. botulinum</i> growth will have a pH of 3.5-7.0, most common pH is 5.5-6.5. Submit food in original container, placing individually in leak proof sealed transport devices.
	Gastric Fluid	X, A	A			20 cc	4 ° C	Collect up to 20 cc
	Intestinal Fluid	A	A				RT	Autopsy: intestinal contents from various areas of the Autopsy: intestinal contents from various areas of the small and large intestines should be provided
Nasal swab				X			For aerosolized botulinum toxin exposure, obtain nasal cultures for <i>C. botulinum</i> and serum for mouse toxicity testing	



Disease/ Agent	Specimen Selection					Specimen Handling		Comments
	Serum	X,A		X	X		4 ° C	Serum should be obtained as soon as possible after the onset of symptoms and before antitoxin is given. A minimum of 10 cc of serum (20 cc of whole blood) is required for mouse toxicity testing. In infants, serum is generally, not useful, since the toxin is quickly absorbed before serum can be obtained.
	Stool	X*	X	X	X		4 ° C	Botulism has been confirmed in infants with only "pea-sized" stools. Please note: anticholinesterase given orally, as in patients with myasthenia gravis, has been shown to interfere with toxin testing
	Vomitus	X					4 ° C	Collect up to 20 cc
	Wound/ tissue			X			RT	Exudate, tissue or swabs must be collected and transported in an anaerobic transport system. Samples from an enema or feces should also be submitted since the wound may not be the source of botulinum-toxin
	Environmental sample		X		X		RT	Environmental swabs



QUICK REFERENCE GUIDE TO SPECIMEN COLLECTION FOR STAPHYLOCOCCAL ENTEROTOXIN B

Disease/ Agent	Specimen Selection	Specimen Handling	Comments
Staphylococcal Enterotoxin B	<p>NOTE: Sentinel laboratories should not accept environmental (including food samples) or animal specimens for testing; such specimens should be forwarded directly to your local LRN Reference Laboratory. Exposure to SEB as a result of a bioterrorist event may include exposure to both the organism <i>S. aureus</i> and the enterotoxin or exposure to the enterotoxin only. Specimens may be tested for both the presence of enterotoxin and the bacterium.</p>	Ship Immediately at 2-8° C	Foods should be left in their original containers if possible or placed in sterile unbreakable containers. Place containers individually in leakproof containers (i.e., sealed plastic bags) to prevent cross-contamination during shipment. Empty containers with remnants of suspected contaminated foods can be examined. Environmental samples such as paper, powder, swabs, wipes, water, and soil can be sent to your local LRN Reference Laboratory for SEB testing.
	<p>Serum is the preferred specimen for testing for inhalation SEB intoxication by detecting antibodies to SEB. Use a red-top or serum separator-type (SST) tube to obtain serum. Samples should be obtained as soon as possible after the onset of symptoms to detect the toxin. Serum should also be collected 7 to 14 days after onset of illness to compare acute- and convalescent- phase antibody titers. Do not send whole blood, since hemolysis during transit will compromise the quality of the specimen.</p>	Ship Immediately at 2-8° C	The tube must be free of anticoagulants. Approximately 10 mL of blood should be drawn to provide 5 mL of serum.
	<p>Nasal swab: Rub dry, sterile swab (Dacron or rayon) on the mucosa of the anterior nares. Place in protective transport tube.</p>	Ship Immediately at 2-8° C	Collect a nasal swab within 24 h of exposure
	<p>Induced Respiratory Sections: Sputum induced by instilling 10 to 25 mL of sterile saline into the nasal passages should be collected into a sterile screw-top container.</p>	Ship Immediately at 2-8° C	
	<p>Urine: A 20 to 30-mL urine sample should be collected from the patient into a sterile screw-top container as soon as possible.</p>	Ship Immediately at 2-8° C	
	<p>Stool/gastric aspirate: A 10 to 50-g sample of stool should be placed in a sterile leakproof container with a screw-top lid.</p>	Ship Immediately at 2-8° C	

Disease/ Agent	Specimen Selection	Specimen Handling	Comments
	Postmortem: Obtain specimens of the intestinal contents from different levels of the small and large bowel. Place 10 g of specimen into a sterile unbreakable container.	Ship Immediately at 2-8° C	
	Culture isolate: If an isolate of <i>S. aureus</i> is recovered from a specimen, it may be sent for toxin testing on an appropriate agar slant that supports its growth or a transport swab.	Ship at room temperature	

Refer to the ASM Sentinel Level Clinical Laboratory Protocols for more detailed information: <http://www.asm.org/index.php/science-skills-in-the-lab/sentinel-guidelines>.

For additional testing information, please contact your local LRN Reference Laboratory.



Bacillus anthracis (ANTHRAX)

RECOMMENDATIONS FOR SAFE LABORATORY PRACTICES

Do not process nonclinical (environmental or animal) specimens in hospital or commercial reference laboratories; restrict processing to human clinical specimens only. Nonclinical specimens should be directed to the designated LRN Reference Laboratory.

All patient specimens can be handled using BSL-2 practices. BSL-3 precautions, wearing gloves and gown and working in a certified Class II biological safety cabinet (BSC) are recommended when performing activities having a high potential for aerosol production. Subcultures should be performed in a BSC and plates should be taped/shrink sealed, and incubated in 5 – 10% CO₂. All additional testing should be performed only in the BSC while wearing gloves to prevent acquiring infection through the skin.

Refer to the Biosafety, Biosecurity and Regulations section contained within this guidance manual, the Biosafety in Microbiological and Biomedical Laboratories (BMBL) (<http://www.cdc.gov/biosafety/publications/bmbl5/>) and Guidelines for Safe Work Practices in Human and Animal Medical Diagnostic Laboratories (<http://www.cdc.gov/mmwr/preview/mmwrhtml/su6101a1.htm>) for more information.

DATE APPROVED:

8 / 1 / 2016

SAFETY CONSIDERATIONS:

As soon as *B. anthracis* is suspected in the laboratory, perform ALL further work within a Class II Biological Safety Cabinet (BSC) using BSL-3 practices.

DISEASE TRANSMISSION AND CLINICAL PRESENTATION

Bacillus anthracis (*B. anthracis*) is a zoonotic organism that can result in four types of infection, depending on the pathogen's point of entry into the body—inhalation, cutaneous, gastrointestinal, and injection. Inhalation of anthrax spores causes the most deadly form of anthrax. If left untreated, 85 to 90% of patients will not survive. Therefore, cultures should not be manipulated on an open bench; BSL-3 protocols are recommended when dealing with potential of aerosol exposure in order to avoid potential laboratory acquired infections (LAI).

B. anthracis (anthrax) can contaminate soil, plants, and water. Animals can be infected when they breathe or ingest spores. Veterinary public health has kept infection rates low in the United States, although sporadic outbreaks do occur in grazing animals. Domestic and livestock animals should be vaccinated annually if they live in an area where animals have been infected.

Humans can become infected when anthrax spores enter the body through breathing, eating or drinking anthrax bacteria or spores, or through cuts or scrapes in the skin. Anthrax is not spread from person to person. Injection anthrax has not been reported in the United States. Although infection rates in the United States are low, certain activities can put people at higher risk. These include working with infected animals or animal products or eating raw or undercooked meat from infected

animals. Laboratorians with high exposure to anthrax cultures are also at increased risk (see safety practices). Once inside the body, active spores can multiply and produce toxins, resulting in severe illness or death.

A vaccine, Anthrax Vaccine Adsorbed (AVA), is available that protects against cutaneous and inhalational anthrax. This vaccine is recommended for groups at high risk of infection. Antibiotics such as ciprofloxacin and doxycycline can be used to prevent anthrax in those who have been exposed but not yet developed symptoms.

SYMPTOMS OF DISEASE

Symptoms of anthrax, as well as the time before they manifest, vary depending on how the bacterium enters the body. It is important to seek treatment as soon as possible if you suspect anthrax infection.

ANTHRAX LESION

Cutaneous anthrax symptoms include blisters or bumps that may itch followed by a painless skin ulcer (eschar) with a black center most often on the face, neck, arms, or hands.



Inhalational and gastrointestinal anthrax have common symptoms such as fever and chills, headache, and nausea and vomiting. Inhalational anthrax can also cause chest discomfort and extreme tiredness, while gastrointestinal anthrax may also result in fainting and swelling of the abdomen.



ACCEPTABLE SAMPLE TYPES

(<http://www.asm.org/index.php/science-skills-in-the-lab/sentinel-guidelines>)

A. Collection and Transport of Clinical Specimens for Laboratory Rule-Out Testing*		
Cutaneous	Vesicular (early) stage	Unroof vesicle and aspirate fluid or collect with two sterile swabs (dacron)
	Eschar (late) stage	Insert swab (dacron) beneath the edge of the eschar, rotate swab or obtain an aspirate. Transport specimens at room temperature.
Gastrointestinal		Stool (> 5 grams...pecan size), collect and transport in a leak proof sealed container
		Collect blood (late stage of infection) directly into an appropriate blood culture bottle (aerobic and anaerobic)
		Transport specimens and bottles at room temperature
Inhalational		Sputum
		Blood: collect directly into an appropriate blood culture bottle (aerobic and anaerobic)
		Cerebral Spinal Fluid only if signs of meningitis occur
		Transport specimens and bottles at room temperature
Postmortem Tissue		Tissue pieces should be collected and kept moist
		Transport in sterile container at room temperature within 1 hour of collection

MICROSCOPY CHARACTERISTICS

GRAM STAIN

Large Gram positive rods. Spores may be found in cultures grown in 5% CO₂ but are not usually in clinical samples.

Gram stain of *Bacillus anthracis*



Gram positive, endospore-forming
Bacillus anthracis



COLONY MORPHOLOGY AND GROWTH CHARACTERISTICS

Colonies are 2-5 mm on BAP at 18-24h; however, growth can be observed as early as 4-8h.

Non-pigmented, non-hemolytic colonies are round with irregular edges, flat or slightly convex with ground glass appearance. There are often “comma-shaped” projections from the edge of the colony, producing the “Medusa head” shape. Colonies have a tenacious consistency that when teased with a loop, the growth will stand up like beaten egg whites.

B. anthracis will NOT grow on MAC or eosin methylene blue agar (EMB) plates.

24 HOURS ON BAP @ 35° C



Colonies on BAP showing "Medusa Head" morphology



Colonies on BAP showing "Tenacious" morphology



BIOCHEMICAL PROFILE AND KEY ORGANISM CHARACTERISTICS

Warning! Using automated systems, including Mass Spectrometry (MALDI-TOF) technology may result in exposure to dangerous pathogens, and could result in erroneous identification, e.g., *Bacillus anthracis* misidentified as *B. cereus*; *Yersinia pestis* misidentified as *Y. pseudotuberculosis*

MALDI-TOF IDENTIFICATION

If your laboratory uses mass spectrometry (MALDI-TOF) for bacterial identification, and if the manufacturer provides your facility with an alternate tube extraction method, it is recommended that the resulting extract be filtered using a 0.2µm (or less) filter. This additional step is recommended to reduce the chance of laboratory contamination with viable bacteria and spores.

CATALASE TEST

Warning! For safety purposes, it is recommended that this test be performed in a BSC, covered petri dish or tube to ensure the containment of aerosols that are produced when the test organism generates a positive result (production of bubbles).

B. anthracis is catalase positive (+).

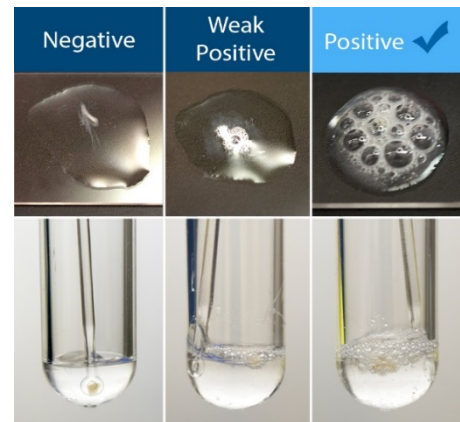

MOTILITY TEST

Performing a motility (wet mount) test is potentially hazardous due to the potential for the creation of an aerosol. Perform a tube motility. These tests must be performed in a BSC.

B. anthracis is a nonmotile organism.

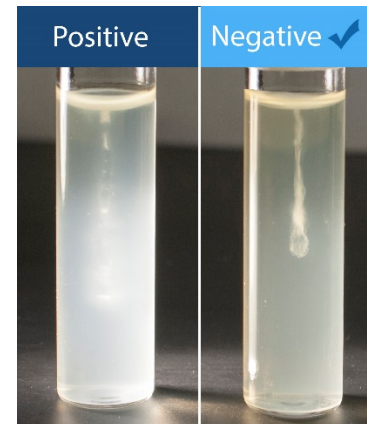

POSSIBLE MISIDENTIFICATIONS FOR *B. anthracis* IN THE LAB:

Possible Misidentifications for <i>B. anthracis</i>	
Agent	Indicator Test Result
<i>B. megaterium</i>	Motility Positive
<i>B. subtilis</i>	Motility Positive
<i>B. cereus</i>	Hemolytic
<i>B. thuringiensis</i>	Hemolytic and not a human pathogen

LABORATORY TESTING INFORMATION

Refer to the ASM Sentinel Level Clinical Laboratory Protocols for more detailed information: <http://www.asm.org/index.php/science-skills-in-the-lab/sentinel-guidelines>. For additional testing information, please contact your local LRN Reference Laboratory.

RULE-OUT FLOWCHART

If you see the following characteristics:

- Rapidly growing, flat, “ground-glass” colonies on BAP
- Large Gram positive rods
- Catalase positive – Use a BSC
- Nonhemolytic
- Non-motile

Then you cannot rule out *B. anthracis*



Bacillus anthracis IDENTIFICATION FLOWCHART

SAFETY: As soon as *B. anthracis* is suspected, perform ALL further work in a Class II BSC using BSL-3 practices.

Major characteristics of *Bacillus anthracis*:

Gram stain morphology: Large, Gram positive rods. Spores may be found in cultures grown in 5% CO₂ but not usually in clinical samples

Colony morphology: Ground glass appearance, non-pigmented, gamma hemolytic (no hemolysis) on BAP,
No growth on MAC (or EMB)

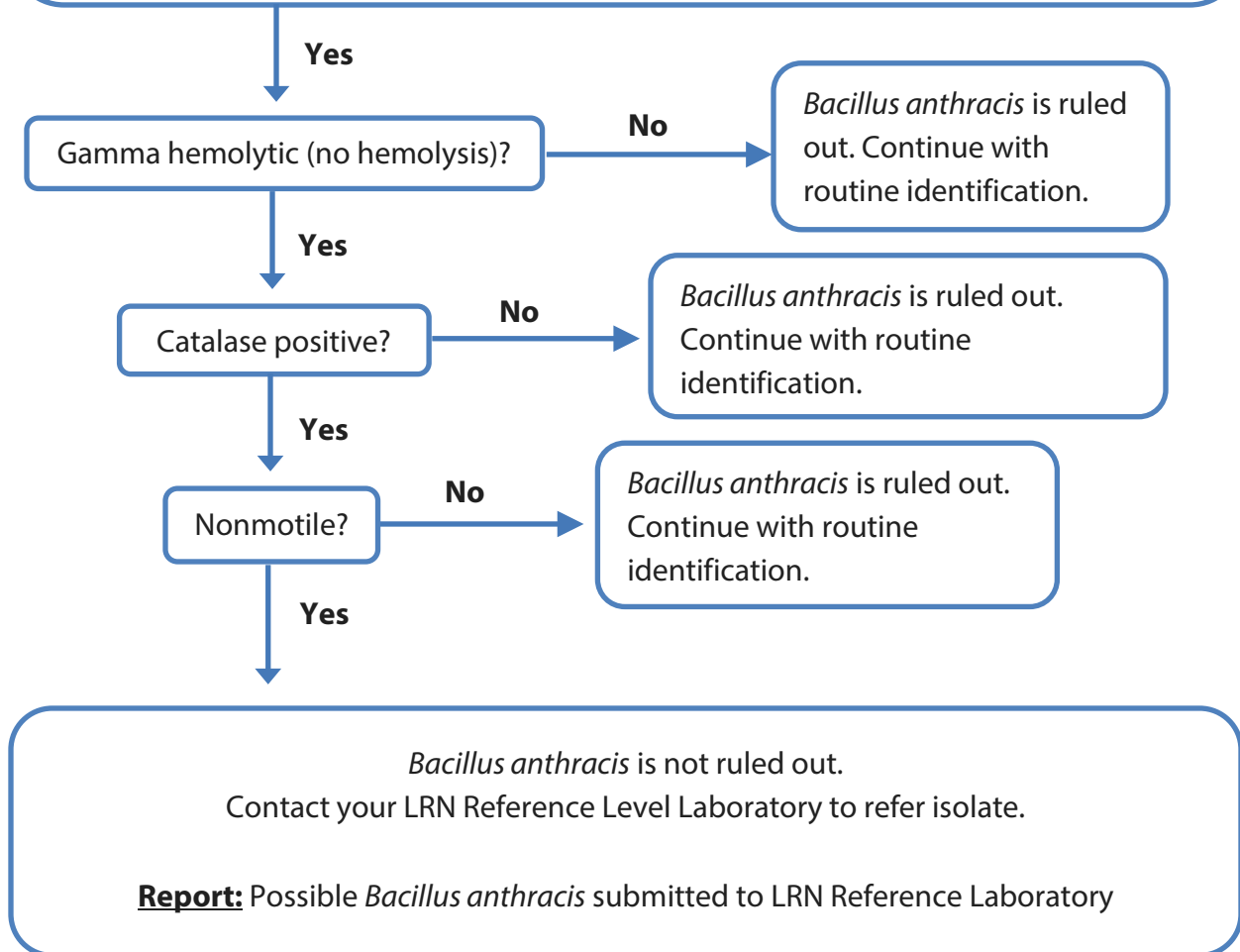

ASM, 3/30/2016

REFER THE PATIENT SPECIMEN OR ISOLATE TO YOUR LOCAL LRN REFERENCE LABORATORY

If the organism cannot be ruled out then you must secure all of the plates, tubes, bottles, slides, and clinical specimens in case the isolate is confirmed as a select agent.

REPORTING AND NOTIFICATION TO STATE OR LOCAL PUBLIC HEALTH

Suspect cases should be immediately reported to the local health department for investigation. Prior to submitting specimens for testing, your LRN Reference Laboratory must be contacted for specimen submission guidance and to provide test notification. For confirmed cases, clinical laboratories must always refer to their State / Local and Federal disease notification and reporting requirements. See your state specific contact information in the State Information and the following link for Federal guidelines. <http://www.selectagents.gov/>

SHIPPING AND TRANSFERS

Upon notification to the local health department epidemiology program and coordination with your local Public Health LRN Reference Laboratory of a suspected *B. anthracis*, laboratories should be prepared to properly package and ship the sample(s). If a culture is being submitted for LRN Rule-Out Testing, the shipment should be classified, handled, packaged and transported as "Suspected Category A." Please note that an organism with a confirmed select agent identification will require a CDC/APHIS Form 2 for transfer. See the *Packaging and Shipping* Section contained within this guidance manual for additional information about sample classification and shipping procedures.

DESTRUCTION AND DECONTAMINATION

The Public Health Agency of Canada has created Pathogen Safety Data Sheets for numerous human pathogens. These technical documents are intended to describe the hazardous properties of listed organisms and recommendations for work involving these agents in a laboratory setting. A complete list of the organisms as well as other safety related information is available here:

<http://www.phac-aspc.gc.ca/lab-bio/res/psds-ftss/index-eng.php>.

If the identification is confirmed then you must either transfer or destroy all remaining materials, isolates, patient samples, etc. within 7 days. Refer to the Biosafety, Biosecurity and Regulations section for directions on how to destroy, secure, or transfer the agent.

(See [DecontaminationSelectAgents JobAid 10 06 2015 Final Job Aid](#)) Work with your LRN Reference Laboratory on how to fill out the required paperwork.

EXPOSURES / MEDICAL/ CASE DEFINITION

For current treatment recommendations, please see the CDC anthrax medical care web site: <http://www.cdc.gov/anthrax/medicalcare/index.html>.

CDC CASE DEFINITION (<http://www.cdc.gov/nndss/>)

A clinically compatible illness with one of the following:

- Culture and identification of *B. anthracis* from clinical specimens by the LRN Reference Laboratory
- Demonstration of *B. anthracis* antigens in tissues by immunohistochemical staining using both *B. anthracis* cell wall and capsule monoclonal antibodies
- Evidence of a four-fold rise in antibodies to protective antigen between acute and convalescent sera or a four-fold change in antibodies to protective antigen in paired convalescent sera using CDC quantitative anti-PA immunoglobulin G (IgG) ELISA testing
- Documented anthrax environmental exposure and evidence of *B. anthracis* DNA (e.g., by LRN-validated polymerase chain reaction) in clinical specimens collected from a normally sterile site (e.g., blood or CSF) or lesion of other affected tissue (skin, pulmonary, reticuloendothelia, or gastrointestinal).

Any potential exposures should be immediately reported to the local health department and will require the completion of CDC-APHIS Form 3. Refer to the Biosafety, Biosecurity, and Regulations Section for more information and guidance ([Form 3: APHIS/CDC Select Agent Job Aid](#)) or the Select Agent website (<http://www.selectagents.gov/form3.html>). You can also contact your LRN Reference Laboratory for assistance.

REFERENCES

CDC Anthrax

<http://www.cdc.gov/anthrax/>

ASM Guidelines: *B. anthracis*

<http://www.asm.org/index.php/science-skills-in-the-lab/sentinel-guidelines>

Pathogen Safety Data Sheet: *B. anthracis*

<http://www.phac-aspc.gc.ca/lab-bio/res/psds-ftss/msds12e-eng.php>

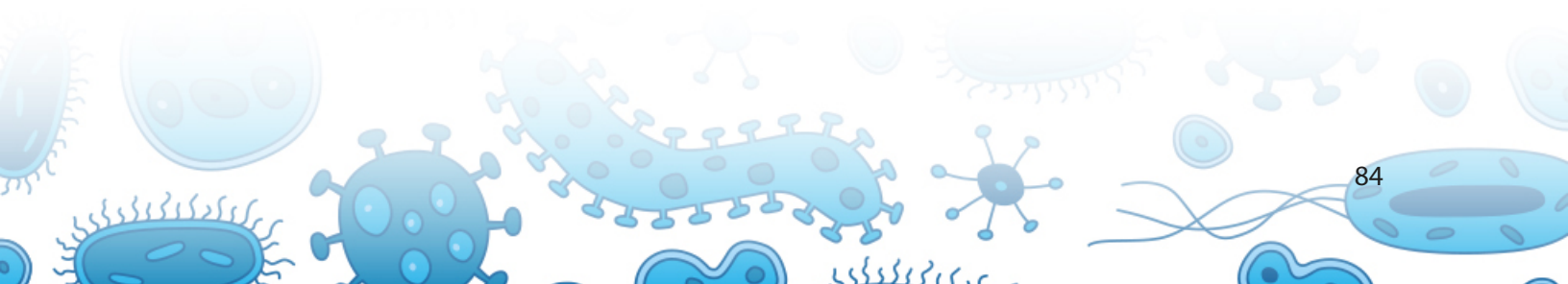

Brucella spp. (*B. abortus*, *B. canis*, *B. melitensis*, and *B. suis*) (BRUCELLOSIS)

WARNING: If a characteristic Gram stain showing tiny, Gram negative coccobacillus is seen along with consistent growth on blood agar of oxidase-positive, catalase-positive, urease-positive, nonmotile colonies (motility is not a recommended sentinel laboratory test for *Brucella*) with no growth on MacConkey agar (MAC), it is likely to be a *Brucella* species. Further identification and manipulations should not be attempted with commercial automated or kit identification systems, because of the potential danger of aerosol production due to preparing high concentrations of organisms. In addition, the identification by these systems can produce false results due to biochemically related organisms in the database, or incomplete databases.

DATE APPROVED:

8 / 1 / 2016

SAFETY CONSIDERATIONS:

As soon as *Brucella* is suspected in the laboratory, perform ALL further work within containment such as a Class II Biological Safety Cabinet (BSC) and follow BSL-3 practices.

RECOMMENDATIONS FOR SAFE LABORATORY PRACTICES

Do not process non-clinical (environmental or animal specimens) in sentinel laboratories. Non-clinical specimens, such as environmental samples should be directed to the designated state or local LRN Reference Laboratory.

Brucella is a highly infectious pathogen. Biosafety Level 2 (BSL-2) practices should be observed for activities involving clinical materials of human or animal origin. If *Brucella* is suspected, or known to be contained within a sample, BSL-3 practices, precautions and containment should be observed for all handling and manipulations of cultures. If a BSL-3 laboratory is not available, BSL-3 practices and precautions should be observed and followed while operating at BSL-2. If *Brucella* is suspected or the Gram stain shows a tiny, gram negative coccobacillus, avoid aerosol generating procedures and perform all subcultures in a Class II Biological Safety Cabinet (BSC). All suspected patient specimens should be handled while wearing gloves and gowns and working in a BSC. Plates should be taped shut, and all further testing should be performed only in the BSC, using BSL-3 practices. Laboratories should conduct a risk assessment for the use of any respiratory protection practices.

Brucellosis is the most commonly reported laboratory-associated bacterial infection. A number of factors contribute to the risk of an accidental *Brucella* laboratory exposure, including:

- Lack of experience working with the organism
- Unknown or unidentified samples that arrive for analysis
- Work performed on a *Brucella* isolate on an open bench, not under containment such as within a Class II BSC, or in BSL-3 conditions.

The primary infection hazards are exposure to aerosols, direct skin contact with cultures or other infectious specimens or material, ingestion, accidental inoculation, or sprays into the mucous membranes such as eyes, nose or mouth.

Certain characteristics of the bacterium, such as its low infectious dose and ease of aerosolization also contribute to the risk of infection by the organism in a laboratory setting. Specific risks include, but are not limited to the following laboratory-related activities:

- Pipetting
- Centrifuging
- Grinding
- Blending
- Shaking
- Mixing
- Sonicating
- Opening containers of infectious materials outside of containment such as a BSC
- Preparing smears, performing heat fixing, staining slides
- Performing a catalase test on an open bench
- Performing wet mount motility test

Those at risk of infection include those who are:

- Practicing a specifically implicated procedure (such as above)
- Manipulating *Brucella* isolates on an open bench without the use of personal protective equipment (PPE) and [recommended practices in the Guidelines for Safe Work Practices in Human and Animal Medical Diagnostic Laboratories](#)
- Present in a laboratory during a *Brucella* aerosol-generating event, such as standing or sitting within five feet of any manipulation of a *Brucella* isolate on an open bench

To help minimize these risks, laboratory workers should follow these recommended risk mitigation steps in addition to wearing appropriate PPE:

- Use primary barriers such as sealed safety centrifuge cups, personal protective equipment, and Class II or higher Biological Safety Cabinets for procedures with a high likelihood of producing droplet splashes or aerosols.
- Use secondary barriers such as restricting access to the laboratory when work is being performed and maintain the integrity of the laboratory's air handling system by keeping external doors and windows closed.
- Perform all procedures on unidentified isolates carefully to minimize the creation of splashes or aerosols.
- Prohibit sniffing of opened culture plates to assist in the identification of isolates.
- Manipulate isolates of small gram-negative or gram-variable coccobacilli /rods within a BSC.



- Do not perform a motility test for the presumptive identification of *Brucella*. This test is not a recommended sentinel lab procedure because *Brucella* does not grow in semi-solid media and wet mount tests increase the risk of an exposure.

Additional information for assessing laboratory risk levels and potential exposures can be found here: <http://www.cdc.gov/brucellosis/laboratories/risk-level.html>.

Laboratory workers should observe and follow the ASM Sentinel Laboratory Guidelines and Protocols, and the CDC recommendations for laboratory containment methods and microbial procedures to ensure compliance with safe laboratory practices in accordance with the [Biosafety in Microbiological and Biomedical Laboratories \(BMBL\) 5th Edition](#). The CDC also provides additional laboratory guidance specifically for work with *Brucella* species, which can be found here: <http://www.cdc.gov/brucellosis/laboratories/safety.html>.

For additional information about risk assessments and general laboratory safety, please refer to those sections within this guidance manual.

DISEASE TRANSMISSION AND CLINICAL PRESENTATION

Although brucellosis can be found worldwide, it is especially found in countries that do not have effective public health and domestic animal health programs. The occurrence of brucellosis often depends on the extent of brucellosis in the area's animal population. Brucellosis is predominantly an occupational disease for those who work with infected animals or their tissues. [According to the CDC Brucella exposure website](#), areas currently listed as high risk are:

- The Mediterranean Basin (Portugal, Spain, Southern France, Italy, Greece, Turkey, North Africa)
- Mexico, South and Central America
- Eastern Europe
- Asia
- Africa
- The Caribbean
- The Middle East

Brucellosis may also be referred to as Undulant fever, Malta fever, Mediterranean fever, Rock of Gibraltar fever, and Bang's disease.

The known host range is humans, cattle, swine, goats, sheep, deer, caribou, elk, dogs, and coyotes. Table 1 below lists the known reservoirs. The exact infectious dose is unknown, however the infectious dose for these organisms is very low if acquired via the inhalation route, which makes them a potentially effective bioterrorism agent and also makes them a significant infection hazard in the clinical microbiology laboratory.

The modes of transmission for brucellosis are through ingestion, inhalation, and direct contact via skin abrasions and mucous membranes. People can become infected when exposed to factors such as contact with infected tissues, blood, urine, vaginal discharge, aborted fetuses; ingestion of raw milk or

cheese from infected animals; contact in abattoirs; laboratory-acquired (generally through aerosolization).

1. **Ingestion:** The most common way to be infected with *Brucella* is by eating, drinking or consuming unpasteurized/raw dairy products. When sheep, goats, cows, or camels are infected, their milk becomes contaminated with the bacteria. If the milk from infected animals is not pasteurized, the infection will be transmitted to people who consume the milk and/or cheese product. Unpasteurized cheeses (sometimes called "village cheeses") may represent a particular risk for tourists. Developing countries often do not have safeguards that can help prevent or monitor possible outbreaks, such as pasteurization laws, animal control/slaughter regulations, and brucellosis surveillance programs. For additional information about identified risk areas, please visit: <http://www.cdc.gov/brucellosis/exposure/areas.html>.
2. **Inhalation:** Breathing in the bacteria that causes brucellosis may also lead to infection. This risk is generally greater for people in laboratories that work with the bacteria. In addition, slaughterhouses and meat-packing employees have also been known to be exposed to the bacteria and ultimately become infected.
3. **Cutaneous and Mucous Membrane:** Bacteria can also enter the body through wounds in the skin or mucous membranes after contact with infected animals. This poses a problem for workers who have close contact with animals or animal excretions such as newborn animals, fetuses, and excretions that may result from birth. Such workers may include slaughterhouse workers, meat-packing plant employees, and veterinarians.

Anyone who is exposed to the bacteria that cause brucellosis is at risk for infection. Some people, based on certain circumstances, may face an increased risk. People in certain occupations or settings may face increased exposure to the bacteria that cause brucellosis. These occupations can include:

- Slaughterhouse workers
- Meat-packing employees
- Veterinarians
- Laboratory workers

Infections are seen in essentially two patient populations. The first is individuals who work with unvaccinated and infected animals. This patient population includes farmers, veterinarians, and slaughterhouse workers. *B. abortus* (cattle) and *B. suis* (pigs) are the agents most likely to cause infections within this group of individuals.

Brucellosis is secondarily seen in individuals who ingest unpasteurized dairy products contaminated with *Brucella*. This is most likely to occur in individuals who travel to or migrate from rural areas of Latin American and the Middle East, or have come into contact with unpasteurized materials from these sources. The disease can be endemic in dairy animals, particularly in goats and camels. *B. melitensis* is the most common agent seen in this patient population.



The dangers of acquiring brucellosis among hunters represent another risk factor, and they can acquire the disease by direct contact with, or aerosolization from infected animal tissues. When they are in contact with infected animals, exposure to the bacteria may occur through skin wounds, accidentally ingesting undercooked meat, inhaling the bacteria while dressing their game. Commonly infected animals include bison, elk, caribou, moose and wild hogs (feral swine).

Laboratory workers are also a group of people who can acquire the infection from direct exposure to cultures of the organism or other contaminated material in the laboratory.

Person to person transmission of brucellosis is extremely rare. Sexual transmission has been rarely reported. While uncommon, transmission may also occur via tissue transplantation or blood transfusions. While rare, human-to-human transmission from lactating mothers to their breastfed infants has been reported. Prompt diagnosis and treatment of brucellosis during pregnancy can be lifesaving for the fetus.

For additional transmission information, please visit:

<http://www.cdc.gov/brucellosis/transmission/index.html>

BRUCELLA SPECIES

Brucella abortus*

The principal host for *Brucella abortus* is cattle (the genus for cattle is *Bos*). In the U.S, eradication of *B. abortus* from cattle is nearly complete, but the disease still occurs in some wild bison and elk herds in the western U.S.

B. abortus RB51 and S19 are vaccine strains of this bacterium developed specifically for immunization of cattle against brucellosis to allow serological differentiation between naturally infected and vaccinated animals. Accidental human exposure to RB51, though uncommon, has resulted in development of symptoms consistent with naturally occurring brucellosis. In a laboratory setting, the risk for accidental exposure to RB51 is highest for procedures or manipulations that occur outside the Class II BSC and that have the potential for creating aerosols or splashes. Exposures have included needle sticks, eye and wound splashes, and contact with infected material. Serological monitoring is available for S19 exposures. It is recommended that laboratories working with the *B. abortus* vaccine strains RB51 or S19 should perform all manipulations in a Class II Biological Safety Cabinet, utilizing BSL-3 practices as described in [Biosafety in Microbiological and Biomedical Laboratories \(BMBL\) 5th Edition](#).

Brucella canis

The principal host for *Brucella canis* is dogs (the genus for dogs is *Canis*). It can also cause infection in humans. Typically, there is a low risk of infection for pet owners. Individuals who are in close contact with dogs, such as breeders, or veterinary staff who assist with birthing however are at an increased risk of becoming infected since they may be exposed to blood, tissues and fluids associated with the birthing process. Currently, there are no serological tests to detect antibodies to *B. canis*. Therefore,

more attention should be given to symptom monitoring. Pet owners who feel that they may have been exposed should contact their local or state health departments for guidance.

Brucella ceti* and *B. pinnipediae

B. ceti and *B. pinnipediae* are relatively recent *Brucella* species to be discovered in marine mammals, and have been associated with a few human cases diagnosed of neurobrucellosis.

***Brucella melitensis* ***

The principal hosts for *B. melitensis* are goats and sheep (the genus for goats is *Capra* and *Ovis* for sheep) and also can be camel (genus *Camelus*). *B. melitensis* is considered to be eradicated in the U.S. since the early 1970s. The sporadic cases in humans in the U.S. occur related to consumption of unpasteurized dairy products from countries where the disease is present. *B. melitensis* is the most prevalent species worldwide and is considered to be the most pathogenic or virulent and causes the most severe and acute cases of brucellosis.

The vaccine strain *B. melitensis* Rev-1 for sheep and goats can also cause infection in humans. Veterinarians and other medical staff performing immunizations in cattle should be aware of the risks and what to do when an exposure occurs. Rev-1 exposures should follow the same assessment guidance as for *B. abortus* RB51. Serological monitoring is available for Rev-1 exposures. It is recommended that laboratories working with the *B. melitensis* Rev-1 vaccine strains should perform all manipulations in a Class II Biological Safety Cabinet, utilizing BSL-3 practices as described in [Biosafety in Microbiological and Biomedical Laboratories \(BMBL\) 5th Edition](#).

Brucella ovis* and *B. neotomae

B. ovis and *B. neotomae* are not known to be pathogenic for humans.

***Brucella suis* ***

The principal host for *B. suis* is swine (the genus for pigs is *Sus*). Since *B. suis* is normally found in pigs, wild hog (feral swine) hunters are at risk of becoming infected when they field dress infected pigs. In 1954, *Brucella suis* became the first biological agent to be weaponized by the United States in the days of its offensive biological warfare program.

NOTE: *Three species of the bacteria; *Brucella abortus*, *Brucella melitensis* and *Brucella suis* are designated as Select Agents and have been identified as having the potential to be developed as bioterrorism agents due to their ability to undergo aerosolization. Additional information about Select Agents may be found here: www.selectagents.gov.

Brucellosis is a zoonotic infection with no identified vectors and with four species being recognized as reservoirs and causing infection in humans: *Brucella abortus* (cattle), *Brucella melitensis* (goats, sheep, and camels), *Brucella suis* (pigs), and *Brucella canis* (dogs). See table 1 below for additional host range and reservoirs.



TABLE 1: BRUCELLA HOST ANIMAL RANGE

Host Animals for <i>Brucella</i> Species	
Species	Main Animal Host(s)
<i>B. abortus</i>	Cattle http://www.cdc.gov/brucellosis/veterinarians/cattle.html
<i>B. canis</i>	Dogs http://www.cdc.gov/brucellosis/veterinarians/dogs.html
<i>B. ceti</i>	Cetaceans (dolphins, porpoises, whales)
<i>B. melitensis</i>	Goats, sheep, camels
<i>B. microti</i>	Common vole
<i>B. neotomae</i>	Wood rats
<i>B. ovis</i>	Sheep, goats
<i>B. pinnipediae</i>	Pinnipeds (seals, sea lions, walruses)
<i>B. suis</i>	Pigs

SIGNS AND SYMPTOMS / CLINICAL PRESENTATION:

The incubation period for brucellosis is highly variable. Symptoms of brucellosis may occur anytime from 5 days to 6 months after initial exposure. Typically the incubation range is 2 to 10 weeks. Symptoms may also disappear for weeks or months only to return at a later date. It has a mortality of 5% in untreated individuals, usually from endocarditis.

Brucella can cause both acute and chronic infections. The symptoms of brucellosis are non-specific and systemic. A brucellosis illness is characterized by acute or insidious onset of intermittent fever and one or more of the following: night sweats, arthralgia, headache, fatigue, anorexia, myalgia, weakness, malaise, back pain, weight loss, arthritis/spondylitis, meningitis, or focal organ involvement (endocarditis, orchitis/epididymitis, hepatomegaly, splenomegaly). Some signs and symptoms may persist for longer periods of time. Others may never go away or reoccur. These can include recurrent fever, arthritis, swelling of the testicles and scrotum area, swelling of the heart (endocarditis), neurologic symptoms (in up to 5% of all cases), chronic fatigue, depression, and swelling of the liver and/or spleen. Gastrointestinal symptoms which are present in 50% of patients include abdominal pain, constipation, diarrhea, and vomiting. The chronic form of the disease can mimic miliary tuberculosis. Chronic untreated brucellosis can lead to abscesses in the liver, spleen, heart valves, brain, or bone; osteoarticular complications; and, in rare cases, death.

For additional information about signs and symptoms, please visit:
<http://www.cdc.gov/brucellosis/symptoms/index.html>.



DIAGNOSING BRUCELLOSIS

Brucellosis is often included in the differential diagnosis of fevers of unknown origin. The diagnosis of human brucellosis cannot be made solely on clinical symptoms since there are varying clinical manifestations and initial symptoms are non-specific. The CDC provides information regarding brucellosis symptoms here: <http://www.cdc.gov/brucellosis/symptoms/index.html> and case definitions including initial and definitive diagnosis here: <http://wwwn.cdc.gov/nndss/conditions/brucellosis/case-definition/2010/>.

The CDC Brucellosis Case Report Form can be found here:

<http://www.cdc.gov/brucellosis/pdf/case-report-form.pdf>

MICROSCOPY CHARACTERISTICS

Warning: Do not attempt to identify tiny Gram negative rods that do not grow on MAC agar using a commercial identification system because of their lack of accuracy and danger of aerosols.

GRAM STAIN

Brucella species are small, faintly staining, Gram negative coccobacilli, or appearing as tiny rods. The Gram stain of *Brucella* is unique in that the organisms are very small, stain poorly or faintly, and tend not to cluster. *Brucella* species will be 0.4 by 0.8 μm .

Note: *Brucella* species Gram stains should not to be confused with poorly staining Gram positive cocci, because of their tiny size. *Brucella* species may also retain Crystal Violet, which can make them appear Gram positive.



DIAGRAM 1, *Brucella* spp. GRAM STAIN

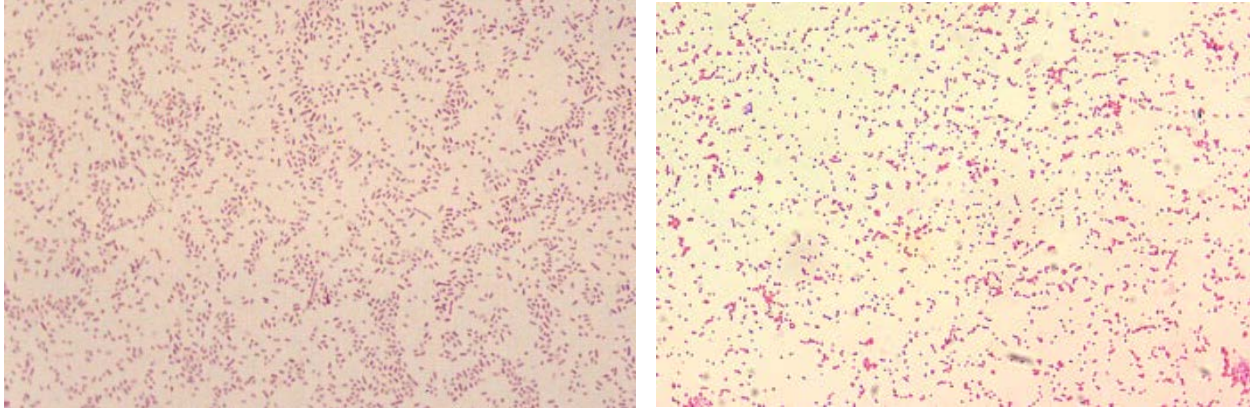

COLONY MORPHOLOGY AND GROWTH CHARACTERISTICS

Brucella species will grow on blood agar (BAP) and chocolate agar (CHOC), but not on MacConkey (MAC) agar or EMB (Eosin methylene blue) agar. *Brucella* is a fastidious, aerobic, non-spore forming, nonmotile, coccobacillus. Culture media should be incubated in 5 to 10% CO₂ to enhance growth. *Brucella* colonies will appear as small to pinpoint, raised, convex white colonies with an entire edge and a shiny surface. The colonies will typically show a “dust-like” growth after overnight incubation (e.g., 18 – 24 hours). A minimum of 48 hours is necessary to get sufficient growth for further identification. Colonies are more easily visible as white, non-pigmented, non-hemolytic colonies (on BAP), and non-mucoid at 48 hours, which further differentiates them from other genera. Colonies are odorless or described as having a non-distinct odor, however it is strongly recommended to NOT sniff culture plates. *Brucella* colonies will be 0.5 to 1.0 mm in diameter after 48 hours of incubation.

Brucella species will grow slowly in aerobic blood culture bottles (e.g., after 2-4 days) and only appearing to grow on subculture after 48 hours of incubation on CHOC and BAP.

To identify *Brucella* to the genus level some biochemical testing is needed, however, automated systems and manual multi-test kit identifications have no place in the identification of the organism, due to its minimal reactivity, creation of aerosols in performance of the testing, the danger of misidentification due to its close relation to other organisms that are positive for only a few tests, and the easy, rapid method to presumptively identify the organism without use of system identifications. Clinically, rapid identification to the genus level is adequate to initiate therapy, and the type of *Brucella* species involved does not alter the therapy. Before the development of molecular techniques, species identification was difficult and, in most cases, was not performed. Species were usually differentiated by their natural host reservoir.

NOTE: Confirmatory identification of *Brucella* species is made by an LRN Reference Laboratory.

BAP AGAR

Colonies on BAP have no distinguishing features. They will appear as white, non-pigmented and non-hemolytic.

24 Hours on BAP

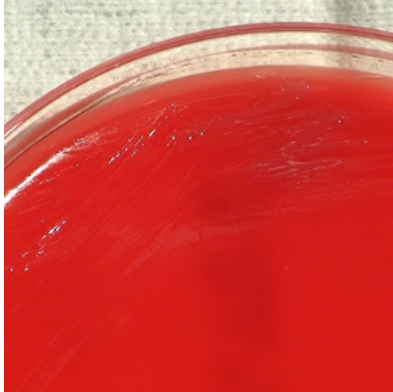

48 Hours on BAP



72 Hours on BAP



CHOC AGAR

Chocolate agar is used to support the growth of fastidious organisms.

24 Hours on CHOC



48 Hours on CHOC



72 Hours on CHOC



MACCONKEY (MAC) AGAR

NOTE: If a Gram negative rod is isolated in a sentinel laboratory and it does not grow on MacConkey agar, it should not be processed for identification by a multi-test kit or automated system.

Brucella species typically does not grow on MAC and will not show the characteristic morphology of other gram negative rods on MAC within 48 hours. Pinpoint colonies have been infrequently observed on MAC after extended incubation times (7 days). Seeing small, gram negative organisms on the Gram stain with addition of the “no growth” observation on MAC will assist in the recognition and suspicion of *Brucella* species in the laboratory, and will aid in the differentiation to separate it from other gram-negative coccobacilli.

24 Hours on MAC

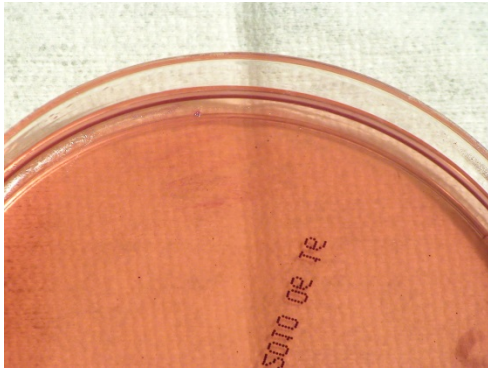

BIOCHEMICAL PROFILE AND KEY ORGANISM CHARACTERISTICS

WARNING: Using automated systems, including Mass Spectrometry (MALDI-TOF) technology may result in exposure to dangerous pathogens, and could result in erroneous identification, e.g., *Bacillus anthracis* misidentified as *B. cereus*; *Yersinia pestis* misidentified as *Y. pseudotuberculosis*.

MALDI-TOF Identification

If your laboratory uses mass spectrometry (MALDI-TOF) for bacterial identification, and if the manufacturer provides your facility with an alternate tube extraction method, it is recommended that the resulting extract be filtered using a 0.2 µm (or less) filter. This additional step is recommended to reduce the chance of laboratory contamination with viable bacteria and spores.

Laboratorians should perform all quality control of media and reagents according to package inserts, most recent CLSI document M22, and CLIA standards, using positive and negative controls. Do not use *Brucella* spp. as a control organism, due to its infectious nature.

Refer to the ASM Sentinel Laboratory Biochemical Recommendations and Test Procedures for additional information:

<http://www.asm.org/index.php/science-skills-in-the-lab/sentinel-guidelines>.

Sentinel Laboratories should perform the minimal amount of testing possible to presumptively identify *Brucella*. The recommended biochemical tests to be performed for presumptive *Brucella* recognition include:

CATALASE

Warning! For safety purposes, it is recommended that this test be performed in a BSC, covered petri dish or tube to ensure the containment of aerosols that are produced when the test organism generates a positive result (production of bubbles).

Brucella spp. are catalase positive (+).

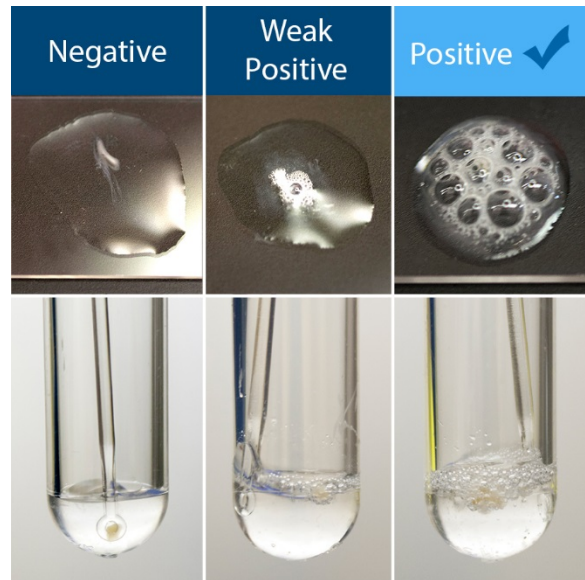

OXIDASE

Brucella species will be oxidase positive. The oxidase test (0.5 tetramethyl-p-phenylenediamine) will have slightly variable results between species. *B. abortus*, *B. melitensis*, and *B. suis* are all oxidase positive (+) organisms and *B. canis* isolates may be oxidase variable.

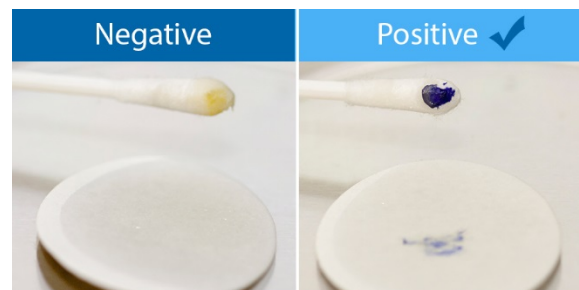

UREA

The urease test can be conducted using Christensen's Urea agar (known as Christensen's method) or rapid urea discs. *Brucella* species will be urease positive with varying times of positive reactions.

Using the Christensen's tube test, urea hydrolysis can be observed in as early as 15 min incubation with *B. suis* and *B. canis* strains and within 1 day of incubation with most strains of *B. abortus*, and *B. melitensis*. Some *B. melitensis* strains can take even longer to be positive. It is recommended to incubate slants or broths aerobically at 35°C and observe for color change to intense magenta or pink at 15 min, 2 hour, and up to 72 hours. If the disc method is used, discs should also be incubated aerobically at 35°C and observe for color development at 15 min to 24 hours.

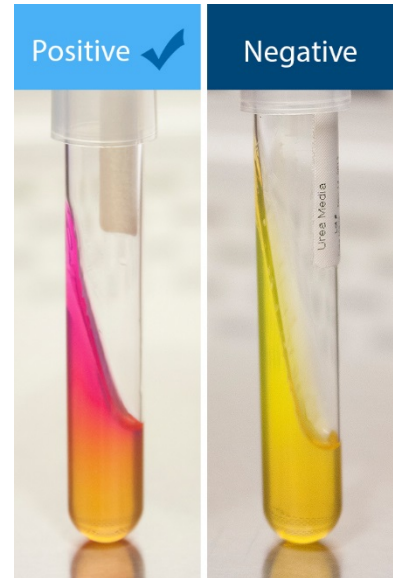

SATELLITE (X/V FACTORS)

Brucella growing on the entire plate. Negative for X and V factors.

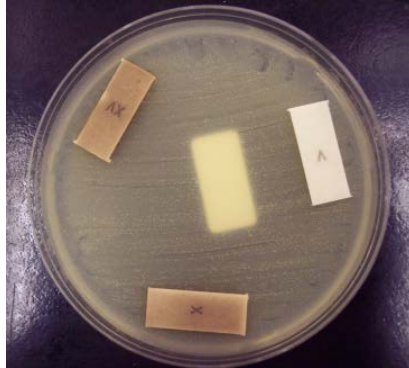

Haemophilus demonstrating growth only around the X and V (combined) disc.

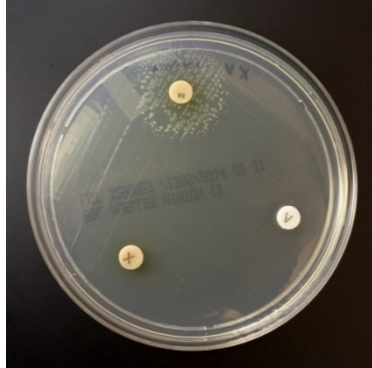

Brucella species can be confused with *Haemophilus*; however *Haemophilus* will not grow on BAP and should be noted when determining differential identifications. When in doubt, differentiate between these two genera by performing a satellite test or an X and V factor test. Satellite test: Inoculate a blood agar plate, followed by cross-streaking or spotting with *Staphylococcus aureus* ATCC 25923. After 24-48 hours of incubation in 5% CO₂, *Haemophilus* will demonstrate satellite growth around the *S. aureus*, while *Brucella* growth will be present on the BAP but is not limited to the area around the *Staphylococcus*. X and V Factor test: Follow the manufacturer's instructions for performing the test. *Brucella* growth will be present on the tryptic soy agar (TSA) but is not limited to the area around the X and V strips/discs. *Haemophilus* will demonstrate growth only around the X and V (combined) strip/disc.

MOTILITY

Although *Brucella* species are nonmotile, motility testing is not a recommended Sentinel Laboratory procedure. *Brucella* species do not grow in semi-solid test medium, and wet mount testing should not be performed due to the unnecessary risk the test presents. Motility testing does not provide useful presumptive identification information after the recommended Sentinel Laboratory procedures.

DRUG RESISTANCE AND SUSCEPTIBILITY

Brucella species are susceptible to tetracyclines and streptomycin or TMP-SMX. *Brucella* is resistant to penicillins and cephalosporins. Antimicrobial susceptibility testing of *Brucella* is neither needed nor appropriate for Sentinel Laboratories to perform. CLSI lists “susceptible only” breakpoints meaning that resistance rarely occurs and should be confirmed in a reference laboratory equipped to test in a BSL-3 facility.

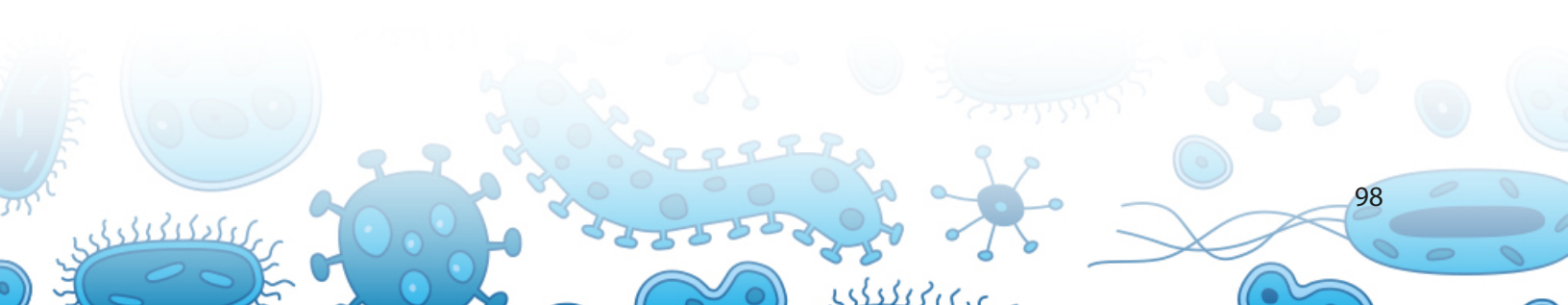

TABLE 2, POSSIBLE MISIDENTIFICATIONS FOR BRUCELLA

Possible Misidentifications for Brucella Include:	
Organism	Differential Test
<p><i>Haemophilus species</i> (Also will appear as tiny coccobacillus in Gram stain)</p>	<p><i>Haemophilus</i> is catalase, urease and oxidase variable. <i>Haemophilus</i> will not grow on blood agar. <i>Haemophilus</i> will demonstrate satellite growth around <i>S. aureus</i> on blood agar, while <i>Brucella</i> growth is present on blood agar, and is not limited to the area around the <i>Staphylococcus</i>.</p>
<p><i>Oligella ureolytica</i> (Also will appear as tiny coccobacillus in Gram stain, usually found only in the urine)</p>	<p>Both this organism and <i>Brucella</i> are catalase, urease and oxidase positive. <i>O. ureolytica</i> will show delayed motility. Note: Since <i>Oligella</i> has poor motility reaction, it would be better ruled-out with PDA which is included in some rapid urea tests. Motility is also not necessary since <i>O. ureolytica</i> is rarely found in the blood or sterile sites where <i>Brucella</i> is more likely to be found. <i>O. ureolytica</i> is a rare urinary pathogen.</p>
<p><i>Psychrobacter phenylpyruvicus</i></p>	<p>Both this organism and <i>Brucella</i> are catalase, urease and oxidase positive.</p>
<p><i>Psychrobacter immobilis</i></p>	<p>Both this organism and <i>Brucella</i> are catalase, urease and oxidase positive. <i>P. immobilis</i> will prefer to grow at 20°C. May have an odor of roses (however, do NOT sniff cultures).</p>
<p><i>Bordetella bronchiseptica</i></p>	<p>Both this organism and <i>Brucella</i> are catalase, urease and oxidase positive. <i>Bordetella bronchiseptica</i> is motile, and <i>Brucella</i> is nonmotile. Note: Motility testing is not needed to rule-out <i>Bordetella</i> since <i>B. bronchiseptica</i> grows on MAC, and is a rarely encountered organism in sterile site specimens.</p>
<p><i>Paracoccus yeei</i></p>	<p>Both this organism and <i>Brucella</i> are catalase, urease and oxidase positive. <i>P. yeei</i> will appear mucoid on BAP.</p>

Brucellosis can be diagnosed in a laboratory by finding bacteria in samples of blood, bone marrow or other bodily fluids. Sentinel Laboratories should always consult with their State or Local LRN Reference Laboratory for appropriate specimens for testing.



BACTERIAL ISOLATION

Isolation of *Brucella* is often delayed compared to other bloodstream pathogens, with peak isolation occurring at 3 to 4 days compared to 6 to 36 hours for most other pathogens. Although incubation time of 21 days with weekly or terminal blind subculture are advocated, careful studies in *Brucella*-endemic areas using automated culture systems suggest that a maximal incubation time of 10 days is sufficient for reliable recovery of this organism. Terminal subcultures at 7 days have been reported to increase yield. *Brucella* is most commonly isolated from blood cultures. It can also, however, be isolated from:

- Bone marrow
- Cerebrospinal fluid
- Wounds
- Purulent discharge
- Joint fluid

TABLE 3. ACCEPTABLE SAMPLE TYPES

Collection and Transport of Clinical Specimens for Laboratory Rule-Out Testing	
Bone marrow or whole blood	Considered the best specimen for culture but can be limited in chronic cases. Collect directly into an appropriate blood culture bottle. Aseptically inoculate liquid blood culture bottles with maximum amount of blood or body fluid per manufacturers' instructions. Incubate at 35°C. Transport bottles at room temperature as soon as possible to obtain the diagnosis. Alternatively, follow the manufacturer's instructions for the lysis-centrifugation method and inoculate pellet to BAP, CHOC and MAC. Incubate plates at 35°C in a humidified incubator with 5 to 10% CO ₂ .
Joint or abdominal fluid	Collect directly into an appropriate blood culture bottle. Transport bottles at room temperature as soon as possible to obtain the diagnosis.
Spleen, liver abscesses	Tissue pieces (at least the size of a pea) should be collected and kept moist. Transport in sterile container at room temperature within 1 hour of collection. May add 1-2 drop of sterile saline to keep moist.
Serum	Collect at least 1 mL without anticoagulant for serologic diagnosis. ¹ Store at 4°C until testing is performed. Acute specimen is collected as soon as possible after onset of disease. Convalescent-phase should be collected >14 (14 – 21) days after the acute specimen.
Tissues	Inoculate BAP, CHOC and MAC and incubate at 35°C in a humidified incubator with 5 to 10% CO ₂ for 7 days (MAC need only be incubated for 3 days at 35°C in ambient air or 5 to 10% CO ₂ .) Humidity may be maintained by placing a pan of water in the bottom of the incubator or by wrapping the plates with gas permeable tape.

¹ Tests include the titrated Rose Bengal test, microagglutination test, microtiter-adapted Coombs test, and immunocapture-agglutination test, all of which are more sensitive than EIA tests, which vary in their sensitivity and specificity.

All plates either from direct inoculation of specimens or from subculture of broths should be examined daily for growth of tiny colonies. When sending specimens to a LRN Reference Laboratory for confirmation, please be sure the laboratory is aware of your suspected diagnosis.

SEROLOGY

In addition to bacterial isolation, serological tests can be performed on some *Brucella* species. CDC utilizes a test called the *Brucella* microagglutination test (BMAT), a modified version of the serum (tube) agglutination test (SAT), that can detect antibodies to *Brucella* species (*abortus*, *melitensis* or *suis*). There is no serological test available to detect antibodies to *B. canis*.

LABORATORY TESTING INFORMATION

Refer to the ASM Sentinel Level Clinical Laboratory Protocols for more detailed information: <http://www.asm.org/index.php/science-skills-in-the-lab/sentinel-guidelines>. For additional testing information, please contact your local LRN Reference Laboratory.

RULE-OUT FLOWCHART

The Sentinel Laboratory Rule-Out or Referral of *Brucella* is accomplished by utilizing the ASM Sentinel Laboratory Guidelines and Protocols, a summary flowchart below will aid in the process.

If you see the following characteristics:

- Tiny faintly staining Gram negative coccobacilli
- Slow growing (48 h) suspicious colonies from agar plates and positive blood culture bottles
- Growth on both BAP and CHOC of pinpoint colonies at 24 h, and more easily seen as white, non-hemolytic, non-mucoid colonies at 48 – 72 h (does not require X & V factor/satellite around *S. aureus*)
- No growth on MAC/EMB
- Catalase (+), oxidase (+), and urease (+)
- NOTE: If a tiny Gram negative rod or coccobacillus is isolated in a Sentinel Laboratory and it does not grow on MacConkey agar, it should not be processed for identification by a multi-test kit or automated system.

Then you cannot rule out *Brucella* spp.



BRUCELLA IDENTIFICATION FLOWCHART

SAFETY: As soon as *Brucella* is suspected, perform ALL further work in a Class II BSC using BSL-3 practices.

Major characteristics of *Brucella* species:

Gram stain morphology: Small (0.4 x 0.8µm), Gram negative coccobacillus
THINK BRUCELLA

Colony morphology: Subculture positive aerobic blood culture to BAP, CHOC. Incubate in 5-10% CO₂ at 35°C, Spot BAP with *S. aureus* ATCC 25923 for satellite test. Note poorly growing colonies after 24 hour incubation on BAP and CHOC.

Incubate plates for at least two additional days if no growth in 24 hours.

Organism does NOT grow on MAC/EMB. (Pinpoint colonies infrequently after extended Incubation; 7 days)

Is the organism only growing on BAP without the need to satellite around the *S. aureus* at 24-48 hours?

No

Consider *Haemophilus*

Yes

Oxidase positive and catalase positive?

No

Think *Francisella* (see procedure)

Yes

Urea positive?

No

Reincubate and see written procedure

Yes

Brucella not ruled out.

Contact LRN Reference Level Laboratory to refer the isolate.

Report: Possible *Brucella* species submitted to LRN Reference Laboratory.
Antimicrobial therapy: Rifampin or Streptomycin plus Doxycycline

ASM, 3/30/16

Refer the Patient Specimen or Isolate to your local LRN Reference Laboratory

If the organism cannot be ruled out then you must secure all of the plates, tubes, bottles, slides, and clinical specimens in case the isolate is confirmed as a select agent.

REPORTING AND NOTIFICATION TO STATE OR LOCAL PUBLIC HEALTH

Suspect cases should be immediately reported to the local health department for investigation. Prior to submitting specimens for testing, your LRN Reference Laboratory must be contacted for specimen submission guidance and to provide test notification. For confirmed cases, clinical laboratories must always refer to their State / Local and Federal disease notification and reporting requirements. See your state specific contact information in the State Section and the following link for Federal guidelines. <http://www.selectagents.gov/>.

When brucellosis is suspected in a patient, clinicians should note "suspect or rule out brucellosis" on the laboratory submission forms to inform any appropriate personnel.

If you see:

- Tiny (0.4 by 0.8 μm), Gram negative, coccobacilli, that faintly stain on a Gram stain;
- Slow growing (48 hour) suspicious colonies from agar plates and positive blood culture bottles;
- Growth on both BAP and CHOC but not on MAC of pinpoint colonies at 24 hour, and more easily seen as white, non-hemolytic, non-mucoid colonies at 48 hour.

NOTE: If a Gram negative rod or coccobacillus is isolated in a Sentinel Laboratory and it does not grow on MacConkey agar, it should not be processed for identification by a multi-test kit or automated system.

If the above criteria are met, perform the following biochemical tests in a BSC:

- Oxidase test; *Brucella* species will be positive
- Catalase test; *Brucella* species will be positive
- Urease test; *Brucella* species will be positive with varying result times

NOTE: Urease production can be delayed and is not required to make the presumptive diagnosis.

Then you cannot Rule-Out *Brucella*. Refer the Specimen or Isolate to your State or Local LRN Reference Laboratory.

1. Generate a report to the physician that *Brucella* species cannot be ruled out.
2. Do not attempt full identification and susceptibility testing in the Sentinel Clinical Laboratory.
3. Immediately notify your designated LRN Reference Laboratory, which will provide the referring laboratory with guidance and recommendations for retaining the specimen or isolate and submission for confirmative identification.

4. Preserve original specimens pursuant to a potential criminal investigation and transfer to your designated LRN Reference Laboratory in accordance with state and local requirements. In particular, the appropriate material, including blood culture bottles, tubes and plates, and actual clinical specimens (aspirates, biopsies, sputum specimens) should be documented, and either submitted to the LRN Reference Laboratory or saved until the Reference Laboratory confirms the identification.
5. Do not ship specimens or cultures to LRN Reference Laboratories without prior arrangements.
6. Notify other public health authorities (e.g. state public health department epidemiologist/health officer) as required by local and state communicable disease reporting requirements. The state public health laboratory/state public health department will notify law enforcement officials (state and federal), such as local FBI agents, as appropriate.
7. Within the hospital setting, immediately notify the infection preventionists and/or infectious disease service so that the patient can be treated appropriately, infectious precautions can be taken, and a further investigation of the patient's history can be made.
8. Consult with the LRN Reference Level Lab about additional clinical specimens that may be submitted for testing.
9. Initiate documentation, showing the specimen identification control, notification and transfer to the designated LRN Reference Laboratory, and documentation of all plates and tube cultures, which will need to be destroyed or transferred once identification has been completed.

Sentinel Laboratories should consult with the designated LRN Reference Laboratory prior to or concurrent with testing, if *Brucella* species is requested by the physician or a bioterrorist event is suspected. Obtain guidance from the state public health laboratory as appropriate (e.g., requests from local law enforcement or other local government officials). FBI and state public health laboratory/state public health department will coordinate the transfer of isolates/specimens to a higher-level LRN laboratory as appropriate.

If *Brucella* species is ruled out, proceed with efforts to identify using established procedures.

Reporting all identified Select Agents is required by completing Form 4 A within 7 days of confirmed identification. If the isolate is from a Proficiency test sample, Form 4 B is to be completed within 90 days of receipt of the sample. Your designated LRN Reference Laboratory will advise you with completion of required forms (e.g., Forms 2, 3, and 4). Always refer to www.selectagents.gov for the latest guidance and versions of these forms.

SHIPPING AND TRANSFERS

Upon notification to the local health department epidemiology program and coordination with your local Public Health LRN Reference Laboratory of a suspected *Brucella*, laboratories should be prepared to properly package and ship the sample(s). If a culture is being submitted for LRN Rule-Out Testing, the shipment should be classified, handled, packaged and transported as "Suspected Category A." Please note that an organism with a confirmed select agent identification will require a CDC/APHIS

Form 2 for transfer. See the *Packaging and Shipping* Section contained within this guidance manual for additional information about sample classification and shipping procedures.

DESTRUCTION AND DECONTAMINATION

The Public Health Agency of Canada has created Pathogen Safety Data Sheets for numerous human pathogens. These technical documents are intended to describe the hazardous properties of listed organisms and recommendations for work involving these agents in a laboratory setting. A complete list of the organisms as well as other safety related information is available here:

<http://www.phac-aspc.gc.ca/lab-bio/res/psds-ftss/index-eng.php>.

Brucella organisms are easily killed by common disinfectants and heat. Standard hospital approved disinfectants are adequate for cleaning patient rooms. Decontamination of laboratory surfaces is easily accomplished using a fresh solution of 10% household bleach. Plates and specimens should be destroyed as directed by the LRN Reference Laboratory when the identification is confirmed.

If the identification is confirmed then you must either transfer or destroy all remaining materials, isolates, patient samples, etc. within 7 days. Refer to the Biosafety, Biosecurity and Regulations section for directions on how to destroy, secure, or transfer the agent.

(See [DecontaminationSelectAgents JobAid 10 06 2015 Final Job Aid](#)) Work with your LRN Reference Laboratory on how to fill out the required paperwork.

Your designated LRN Reference Laboratory must advise you on destruction or transfer of isolates. Generally, all plates and clinical material that contain the organism should be autoclaved, incinerated on-site or submitted to the designated LRN Reference Laboratory for disposal. Alternatively, contaminated items should be soaked in 10% bleach or 10% formalin for 24 hours.

Brucella organisms can survive in carcasses and organs for up to 135 days, on paper for 32 days, in soil for 125 days, and in blood at 4°C for 180 days. *Brucella* species are susceptible to many disinfectants such as 1% sodium hypochlorite, 70% ethanol, iodine/alcohol solutions, glutaraldehyde, and formaldehyde. They are susceptible to moist heat (121°C for at least 15 min) and dry heat (160-170°C for at least 1 hour). *Brucella* material should be decontaminated before disposal when possible (steam sterilization, incineration, chemical disinfection).

If a spill occurs, allow aerosols to settle; wearing protective clothing, gently cover spill with paper towels and apply 1% sodium hypochlorite, starting at perimeter and working towards the center; allow sufficient contact time (30 min) before clean up.

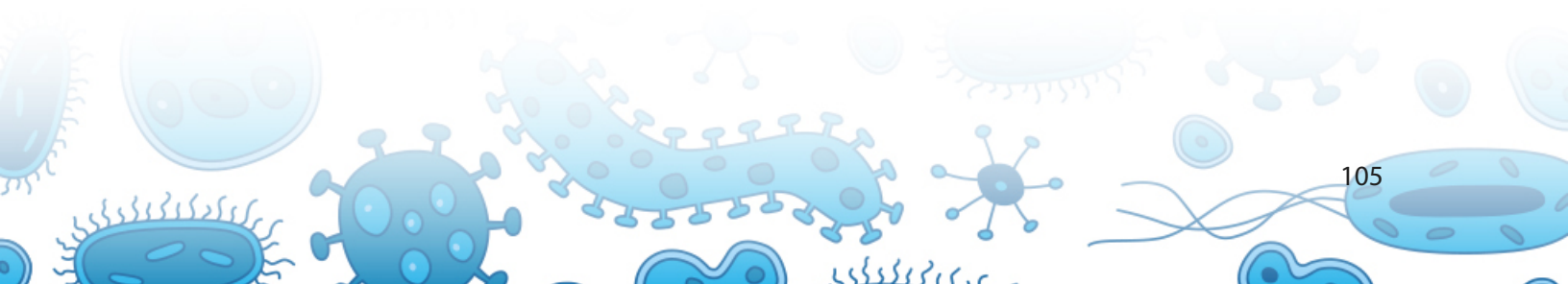

EXPOSURES AND MEDICAL TREATMENT

For those at risk of exposure, recommendations will vary depending on whether the risk is high or low. The CDC provides specific *Brucella* risk level guidance to guide lab workers on how to determine their risk level, which can be found here: <http://www.cdc.gov/brucellosis/laboratories/risk-level.html>.

Reported activities related to *Brucella* exposure include:

- Sniffing bacteriological cultures
- Direct contact with cut or abraded skin
- Mouth pipetting
- Inoculations
- Sprays into eyes, nose, and mouth

There are currently no vaccines available for use in humans in the U.S. and no identified prophylaxis.

SEROLOGICAL MONITORING AFTER LABORATORY EXPOSURE

The immune response to *Brucella* is characterized by an initial production of IgM antibodies followed afterward by the production of IgG antibodies. The major antigens that are useful for diagnosis of brucellosis are the smooth (S) lipopolysaccharide (LPS) of the outer membrane and internal proteins. The serum (tube) agglutination test (SAT) detects antibodies to the S-LPS. Antibodies reacting against S-LPS can also be detected by other tests, such as ELISA (enzyme-linked immunosorbent assay) and the Coombs test. It is important to note that the Coombs test remains positive longer than other agglutination tests. CDC recommends that *Brucella* serology testing only be performed using tests approved by the Food and Drug Administration (FDA), or validated under the Clinical Laboratory Improvement Amendments (CLIA) and shown to reliably detect the presence of *Brucella* antibodies. Results from these tests should be considered supportive evidence for recent infection only and interpreted in the context of a clinically compatible illness and exposure history. Serology for laboratory workers exposed to *Brucella* are drawn at 0, 6, 12, 18 and 24 weeks post exposure.

Any potential exposures should be immediately reported to the local health department and will require the completion of CDC-APHIS Form 3. Refer to the Biosafety, Biosecurity, and Regulations Section for more information and guidance ([Form 3: APHIS/CDC Select Agent Job Aid](#)) or the Select Agent website (<http://www.selectagents.gov/form3.html>). You can also contact your LRN Reference Laboratory for assistance.

For current treatment recommendations, including post-exposure prophylaxis information, please visit the CDC *Brucellosis* page. <http://www.cdc.gov/brucellosis/laboratories/risk-level.html>

REFERENCES

ASM Sentinel Lab Guidelines for Brucella
<http://www.asm.org/images/PSAB/LRN/Brucella316.pdf>

Public Health Agency of Canada, Brucella Pathogen Safety Data Sheet

<http://www.phac-aspc.gc.ca/lab-bio/res/psds-ftss/msds23e-eng.php>

CDC Case Definition

<http://wwwn.cdc.gov/nndss/conditions/brucellosis/case-definition/2010/>

MMWR ARTICLES

CDC. [Human Exposures to Marine *Brucella* Isolated from a Harbor Porpoise - Maine, 2012](#). MMWR 2012; 61(25):461-463.

CDC. [Brucella suis Infection Associated with Feral Swine Hunting --- Three States, 2007--2008](#). MMWR 2009; 58(22):618-621.

CDC. [Public Health Consequences of a False-Positive Laboratory Test Result for *Brucella* --- Florida, Georgia, and Michigan, 2005](#). MMWR 2008; 57(22):603-605.

CDC. [Update: Potential Exposures to Attenuated Vaccine Strain *Brucella abortus* RB51 During a Laboratory Proficiency Test --- United States and Canada, 2007](#). MMWR 2008; 57(2):36-39.

CDC. [Laboratory-Acquired Brucellosis --- Indiana and Minnesota, 2006](#). MMWR January 18, 2008; 57(2):39-42.

CDC. [Notice to Readers: Potential Exposure to Attenuated Vaccine Strain *Brucella abortus* RB51 During a Laboratory Proficiency Test --- United States, 2007](#). MMWR 2007; 56(50):1320-1321.

CDC. [Suspected Brucellosis Case Prompts Investigation of Possible Bioterrorism-Related Activity --- New Hampshire and Massachusetts, 1999](#). MMWR June 16, 2000; 49(23):509-512.

CDC. [Human Exposure to *Brucella abortus* Strain RB51 -- Kansas, 1997](#). MMWR March 13, 1998; 47(9):172-175.

CDC. [Case Definitions for Infectious Conditions Under Public Health Surveillance](#). MMWR May 2, 1997; 46(RR10):1-55.

CDC. Guidelines for Safe Work Practices in Human and Animal Medical Diagnostic Laboratories <http://www.cdc.gov/mmwr/preview/mmwrhtml/su6101a1.htm>. MMWR January 6, 2012 / 61(01);1-101.

EID ARTICLES

CDC. [Laboratory Exposures to Brucellae and Implications for Bioterrorism](#). EID Volume 11, Number 8- August 2005.

FACT SHEETS

<http://www.cdc.gov/brucellosis/exposure/occupational-risks.html>



Burkholderia mallei (GLANDERS)

RECOMMENDATIONS FOR SAFE LABORATORY PRACTICES

Burkholderia mallei is an infectious organism. Exposure occurs through aerosolization, and infections in the clinical/research laboratory have occurred as a result of manipulating cultures outside of a biosafety cabinet (BSC). Any procedure that can generate an aerosol should be performed in a biosafety cabinet. All patient specimens and culture isolates should be handled while wearing gloves and appropriate PPE.

Refer to the Biosafety, Biosecurity and Regulations section contained within this guidance manual, the Biosafety in Microbiological and Biomedical Laboratories (BMBL) (<http://www.cdc.gov/biosafety/publications/bmb15/>) and Guidelines for Safe Work Practices in Human and Animal Medical Diagnostic Laboratories

(<http://www.cdc.gov/mmwr/preview/mmwrhtml/su6101a1.htm>) for more information.

DATE APPROVED:

8 / 1 / 2016

SAFETY CONSIDERATIONS:

As soon as *Burkholderia mallei* is suspected in the laboratory, perform ALL further work within in containment such as within a Class II Biological Safety Cabinet (BSC) and observe and follow BSL-3 practices.

DISEASE TRANSMISSION AND CLINICAL PRESENTATION

<http://www.cdc.gov/glanders/>

Glanders is an infectious disease that is caused by the bacterium *Burkholderia mallei*. Glanders is primarily a disease affecting horses, and human infections are extremely rare. It also affects donkeys and mules and can be naturally contracted by other mammals such as goats, dogs, and cats. Equines are the primary reservoir. *Burkholderia mallei* has been documented as a biowarfare agent in World War I.

Symptoms of glanders commonly include:

- Fever with chills and sweating
- Muscle aches
- Chest pain
- Muscle tightness
- Headache
- Nasal discharge
- Light sensitivity (sometimes with excessive tearing of the eyes)

The particular symptoms experienced, however, will vary depending on the type of infection. Infection of *Burkholderia mallei* in humans is often fatal without medical intervention. The incubation period is typically one to fourteen days. The four types of infection are localized, pulmonary, bloodstream, and chronic.

ACCEPTABLE SAMPLE TYPES

<http://www.asm.org/index.php/science-skills-in-the-lab/sentinel-guidelines>

Collection and Transport of Clinical Specimens for Laboratory Rule-Out Testing	
Bone marrow or whole blood	<ul style="list-style-type: none">• Considered the best specimen for culture• Collect directly into an appropriate blood culture bottle• Transport bottles at room temperature as soon as possible to obtain the diagnosis
Sputum or bronchoscopically obtained specimens	<ul style="list-style-type: none">• Collect expectorated specimen into sterile transport cup or collect during bronchoscopy procedure.• Transport at room temperature up to 2h• If it is known that material will be transported from 2-24 h after collection, then store and transport at 2-8°C.
Tissue specimens (biopsies, abscess aspirates) and wound swabs	<ul style="list-style-type: none">• Tissue pieces (at least the size of a pea) should be collected and kept moist• Transport in sterile container at room temperature within 1 hour of collection• Alternatively a swab from a tissue sample can be submitted in hospital transport tube with medium to stabilize specimen (e.g. Amies charcoal).
Urine	<ul style="list-style-type: none">• Collect at least 1 mL into leak-proof container• Transport at room temperature up to 2 h• Refrigerate 2 up to 24 h until culture inoculation

MICROSCOPY CHARACTERISTICS

GRAM STAIN

- Small, Gram negative bacilli or slightly curved coccobacilli
- Cells are arranged in pairs, parallel bundles, or the Chinese-letter form

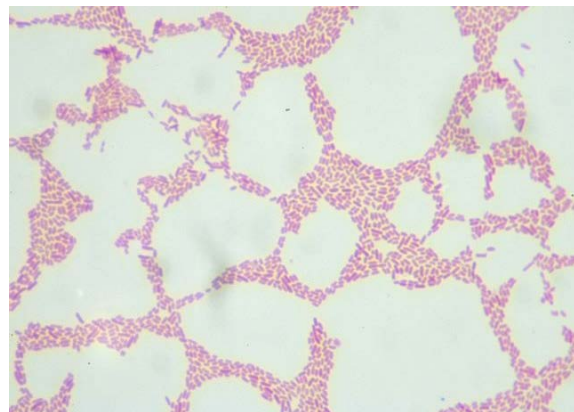

COLONY MORPHOLOGY

- Pinpoint colonies on Sheep Blood agar (BAP) after 24 h
- Smooth, gray, translucent on BAP after 48 h
- No growth or pinpoint colonies on MAC or EMB after 72 h
- No growth at 42°C at 48 h
- Resistant to colistin and polymyxin B
- Resistant to penicillin
- Susceptible to amoxicillin/clavulanic acid
- No pigment on Mueller Hinton agar

24 HOURS ON BAP



72 HOURS ON BAP



48 HOURS ON BAP



24 HOURS ON CHOC

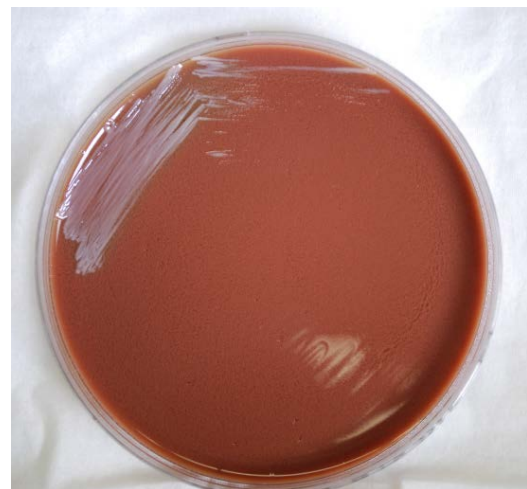

48 HOURS on CHOC

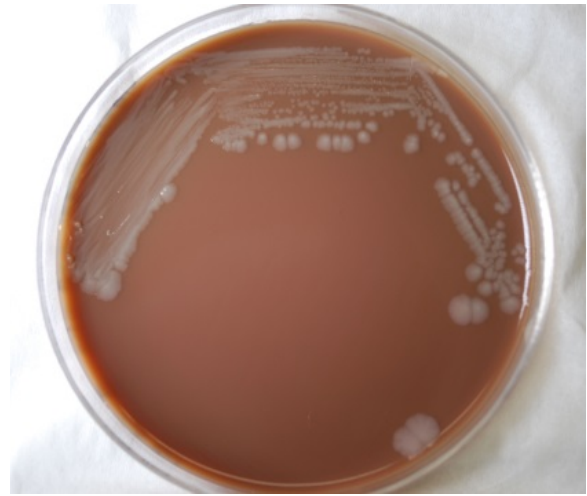
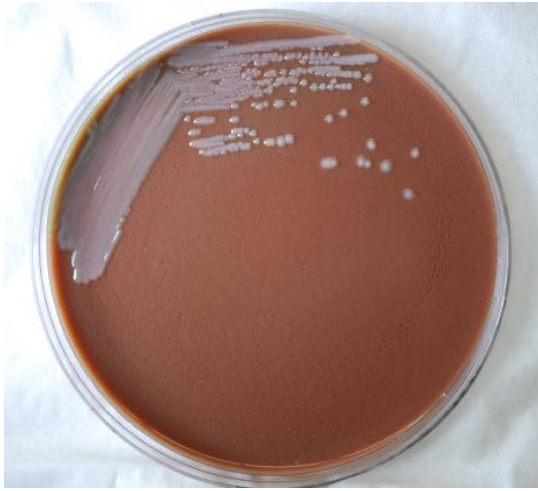

72 HOURS on CHOC

BIOCHEMICAL PROFILE AND KEY ORGANISM CHARACTERISTICS

WARNING: Using automated systems, including Mass Spectrometry (MALDI-TOF) technology may result in exposure to dangerous pathogens, and could result in erroneous identification, e.g., *Bacillus anthracis* misidentified as *B. cereus*; *Yersinia pestis* misidentified as *Y. pseudotuberculosis*.

MALDI-TOF IDENTIFICATION

If your laboratory uses mass spectrometry (MALDI-TOF) for bacterial identification, and if the manufacturer provides your facility with an alternate tube extraction method, it is recommended that the resulting extract be filtered using a 0.2 μm (or less) filter. This additional step is recommended to reduce the chance of laboratory contamination with viable bacteria and spores.

BIOCHEMICAL TESTS TO BE PERFORMED INCLUDE:

CATALASE

Warning! For safety purposes, it is recommended that this test be performed in a BSC, covered petri dish or tube to ensure the containment of aerosols that are produced when the test organism generates a positive result (production of bubbles).

Burkholderia mallei is catalase (+).

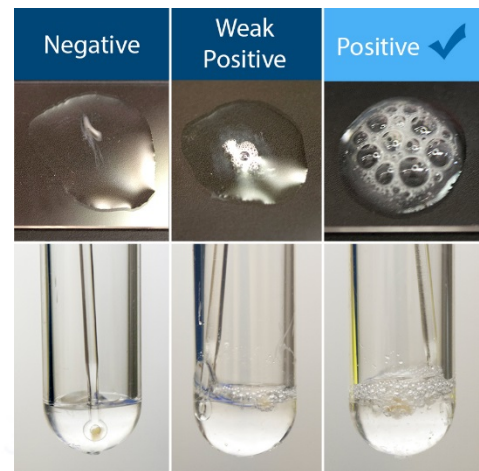

INDOLE

Burkholderia mallei is indole negative (-).



MOTILITY

Use Motility Test Medium with 2,3,5-triphenyltetrazolium chloride (TTC).

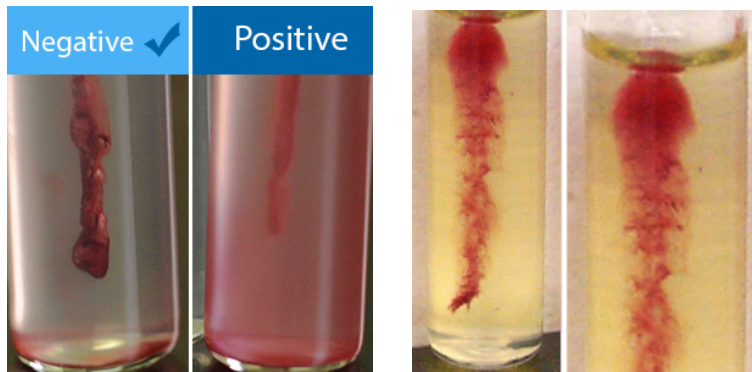

Burkholderia mallei is nonmotile (-).

OXIDASE

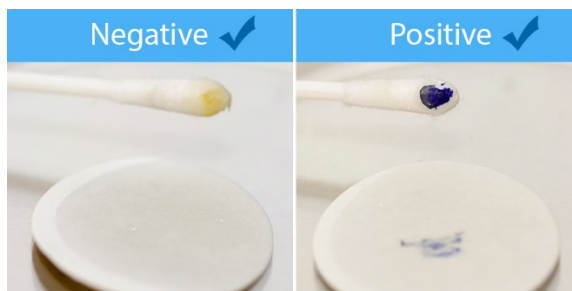

Burkholderia mallei is oxidase variable.

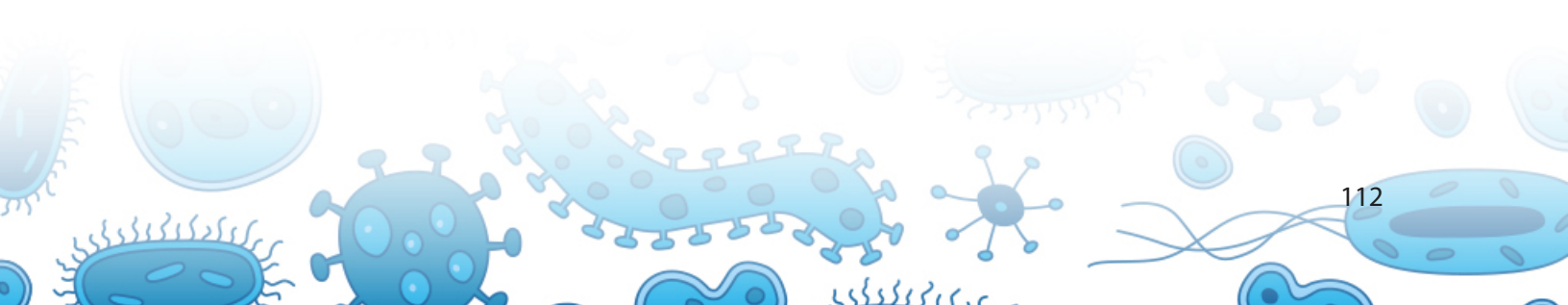

ADDITIONAL SCREENING TEST ARGININE DIHYDROLASE (DECARBOXYLASE):

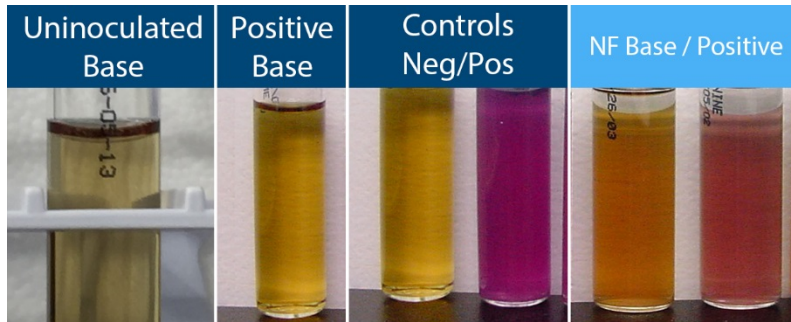

Burkholderia mallei is arginine positive. (see NF Base/Positive)

POSSIBLE MISIDENTIFICATIONS

Possible Misidentifications for <i>Burkholderia mallei</i> Include:	
Organism	Differential Test
<i>Burkholderia cepacia</i>	Resistant to amoxicillin-clavulanic acid, lactose fermenter (LF) on MacConkey and EMB, motile, arginine negative
<i>Chromobacterium violaceum</i>	Hemolysis, violet pigment on BAP, motile
<i>Pseudomonas stutzeri</i>	Growth on MacConkey, arginine negative
<i>S. maltophilia</i>	Growth on MacConkey, arginine negative
<i>Bacillus</i> spp. may appear Gram negative	Sensitive to penicillin
<i>Pandoraea</i> spp.	Growth on MacConkey
<i>Ralstonia</i> spp.	Growth on MacConkey

LABORATORY TESTING INFORMATION

Refer to the ASM Sentinel Level Clinical Laboratory Protocols for more detailed information: <http://www.asm.org/index.php/science-skills-in-the-lab/sentinel-guidelines>. For additional testing information, please contact your local LRN Reference Laboratory.

RULE-OUT FLOWCHART

If you see the following characteristics:

- Small, Gram negative coccobacilli
- Smooth, gray, translucent colonies on BAP without hemolysis or distinctive odor
- Catalase (+), Oxidase variable, Indole (-)
- Nonmotile
- Resistant to Polymyxin B or colistin
- Susceptible to amoxicillin-clavulanic acid
- Resistant to penicillin
- No growth at 42 degrees Celsius
- And cannot rule out *Burkholderia mallei* using the protocol flow chart....

Then you cannot rule out *B. mallei*

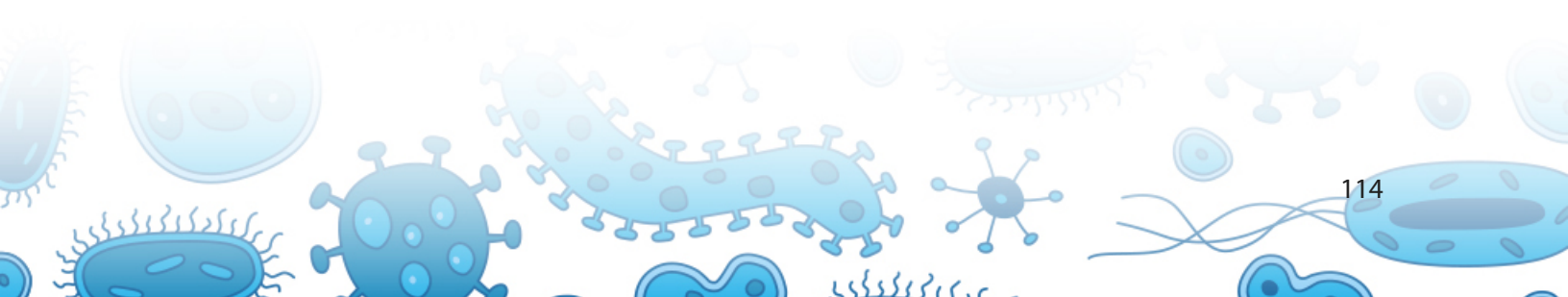

Burkholderia mallei IDENTIFICATION FLOWCHART

SAFETY: As soon as *Burkholderia* is suspected, perform ALL further work in a Class II BSC using BSL-3 practices.

Major characteristics of *Burkholderia mallei*:

Gram stain morphology: Gram negative coccobacilli or small rods

Colony morphology: Poor growth at 24 hr; better growth of gray, translucent colonies without pigment or hemolysis at 48 hours on BAP; poor or no growth on MAC/EMB in 48 h; no distinctive odor

Reactions: Oxidase-variable; indole negative; catalase positive

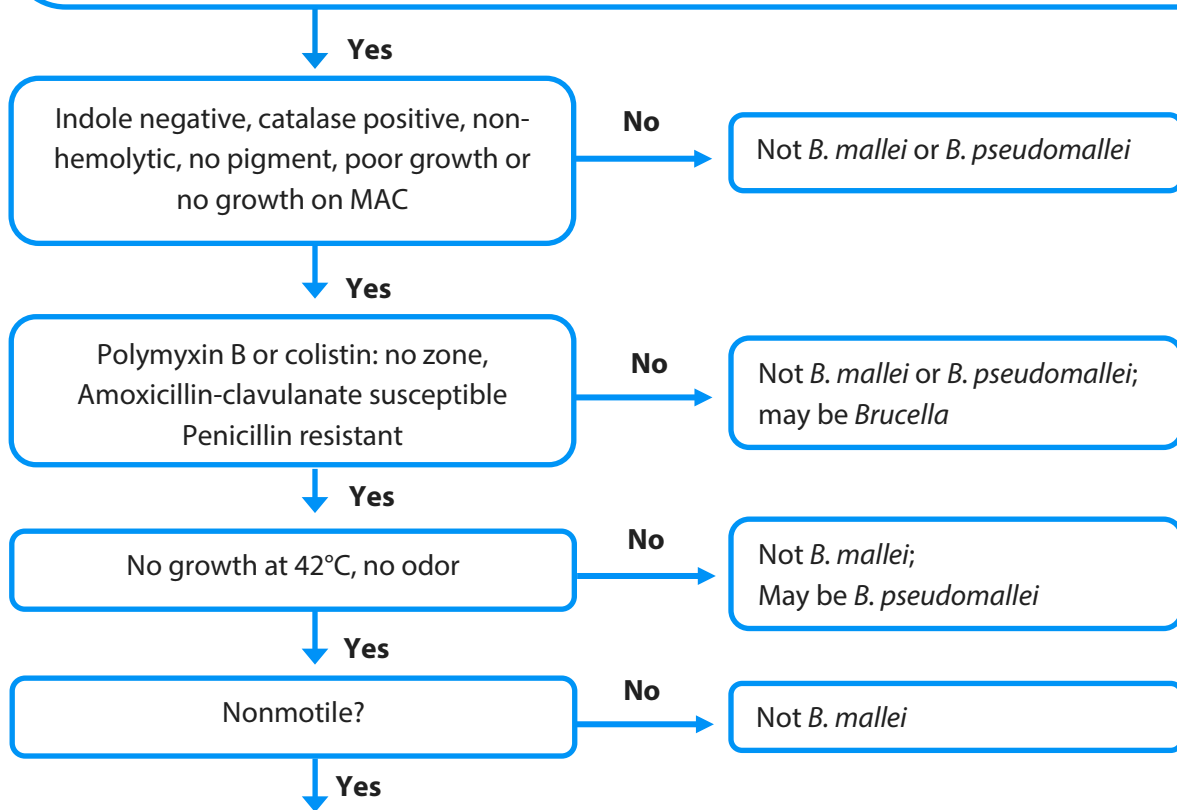

B. mallei not ruled out.

Contact your LRN Reference Level Laboratory to refer isolate.

Report: Possible *Burkholderia mallei* submitted to LRN Reference Level Laboratory.

Additional screening test: *B. mallei* and *B. pseudomallei* are Arginine positive, unlike many other *Burkholderia* spp. (Test can be observed in kit identification systems.)

Refer the Patient Specimen or Isolate to your local LRN Reference Laboratory

If the organism cannot be ruled out then you must secure all of the plates, tubes, bottles, slides, and clinical specimens in case the isolate is confirmed as a select agent. Please refer to the *Burkholderia mallei* identification flow chart and bench card.

REPORTING AND NOTIFICATION TO STATE OR LOCAL PUBLIC HEALTH

Suspect cases should be immediately reported to the local health department for investigation. Prior to submitting specimens for testing, your LRN Reference Laboratory must be contacted for specimen submission guidance and to provide test notification. For confirmed cases, clinical laboratories must always refer to their State / Local and Federal disease notification and reporting requirements. See your state specific contact information in the State Section and the following link for Federal guidelines. <http://www.selectagents.gov/>

SHIPPING AND TRANSFERS

Upon notification to the local health department epidemiology program and coordination with your local Public Health LRN Reference Laboratory of suspected *Burkholderia mallei*, laboratories should be prepared to properly package and ship the sample(s). If a culture is being submitted for LRN Rule-Out Testing, the shipment should be classified, handled, packaged and transported as "Suspected Category A." Please note that an organism with a confirmed select agent identification will require a CDC/APHIS Form 2 for transfer. See the *Packaging and Shipping* Section contained within this guidance manual for additional information about sample classification and shipping procedures.

DESTRUCTION AND DECONTAMINATION

The Public Health Agency of Canada has created Pathogen Safety Data Sheets for numerous human pathogens. These technical documents are intended to describe the hazardous properties of listed organisms and recommendations for work involving these agents in a laboratory setting. A complete list of the organisms as well as other safety related information is available here:

<http://www.phac-aspc.gc.ca/lab-bio/res/psds-ftss/index-eng.php>.

The Pathogen Safety Data Sheet for *Burkholderia mallei* is available here:

<http://www.phac-aspc.gc.ca/lab-bio/res/psds-ftss/msds25e-eng.php>

If the identification is confirmed then you must either transfer or destroy all remaining materials, isolates, patient samples, etc. within 7 days. Refer to the Biosafety, Biosecurity and Regulations section for directions on how to destroy, secure, or transfer the agent (See [DecontaminationSelectAgents_JobAid_10_06_2015_Final_Job_Aid](#)). Work with your LRN Reference Laboratory on how to fill out the required paperwork.

EXPOSURES / MEDICAL/ CASE DEFINITION

Since human cases of glanders are rare, there is limited information about antibiotic treatment in humans. Sulfadiazine has been found to be an effective in experimental animals and in humans.

For current treatment recommendations, please go to the CDC Glanders web site:

<http://www.cdc.gov/glanders/>.

Any potential exposure should be immediately reported to the local health department and will require the completion of CDC-APHIS Form 3. Refer to the Biosafety, Biosecurity, and Regulations Section for more information and guidance ([Form 3: APHIS/CDC Select Agent Job Aid](#)) or the Select Agent website (<http://www.selectagents.gov/form3.html>). You can also contact your LRN Reference Laboratory for assistance.

REFERENCES

ASM Guidelines: *Burkholderia mallei*

<http://www.asm.org/index.php/science-skills-in-the-lab/sentinel-guidelines>

Pathogen Safety Data Sheet: *Burkholderia mallei*

<http://www.phac-aspc.gc.ca/lab-bio/res/psds-ftss/msds25e-eng.php>

Biosafety in Microbiological and Biomedical Laboratories (BMBL)

<http://www.cdc.gov/biosafety/publications/bmb15/>

Glanders information

<http://www.cdc.gov/glanders/>



Burkholderia pseudomallei (MELIOIDOSIS)

RECOMMENDATIONS FOR SAFE LABORATORY PRACTICES

Burkholderia pseudomallei is a highly infectious organism, and laboratory exposures have been documented. Exposure occurs through aerosolization, and infections in the clinical/research laboratory have occurred as a result of manipulating cultures outside of a biosafety cabinet (BSC). Any procedure that can generate an aerosol should be performed in a biosafety cabinet. All patient specimens and culture isolates should be handled while wearing gloves and appropriate PPE.

Refer to the Biosafety, Biosecurity and Regulations section contained within this guidance manual, the Biosafety in Microbiological and Biomedical Laboratories (BMBL) (<http://www.cdc.gov/biosafety/publications/bmb15/>) and Guidelines for Safe Work Practices in Human and Animal Medical Diagnostic Laboratories (<http://www.cdc.gov/mmwr/preview/mmwrhtml/su6101a1.htm>) for more information.

DATE APPROVED:

8 / 1 / 2016

SAFETY CONSIDERATIONS:

As soon as *Burkholderia pseudomallei* is suspected in the laboratory, perform ALL further work within in containment such as within a Class II Biological Safety Cabinet (BSC) and observe and follow BSL-3 practices.

DISEASE TRANSMISSION AND CLINICAL PRESENTATION

Melioidosis is caused by exposure to the Gram negative bacillus, *Burkholderia pseudomallei*, and infection can occur in both humans and animals. Melioidosis is also called Whitmore's disease, and it is considered to be primarily a tropical disease. In addition, melioidosis is sometimes referred to as the "Vietnam time bomb" since the disease can reactivate in returning Vietnam veterans after many years in latency.

Common routes of infection include:

- Inhalation of contaminated dust, water droplets, or infectious aerosols
- Ingestion of contaminated water
- Contact with contaminated soil

Melioidosis has a wide range of symptoms that can mimic other diseases, including tuberculosis and common forms of pneumonia. Generally, symptoms appear two to four weeks after exposure, and treatment usually consists of an intensive phase with intravenous anti-microbial therapy for a minimum of 10 days, followed by an eradication phase with oral therapy for three to six months. The following types of infection and symptoms are listed below:

- Localized infection: localized pain or swelling, fever, ulceration, abscess
- Pulmonary infection: cough, chest pain, high fever, headache, anorexia

- Bloodstream infection: fever, headache, respiratory distress, abdominal discomfort, joint pain, disorientation
- Disseminated infection: fever, weight loss, stomach or chest pain, muscle or joint pain, headache, seizures

No vaccine is currently available for humans or animals to prevent infections with *Burkholderia pseudomallei*.

ACCEPTABLE SAMPLE TYPES

<http://www.asm.org/index.php/science-skills-in-the-lab/sentinel-guidelines>

Collection and Transport of Clinical Specimens for Laboratory Rule-Out Testing	
Bone marrow or whole blood	<ul style="list-style-type: none"> • Considered the best specimen for culture • Collect directly into an appropriate blood culture bottle • Transport bottles at room temperature as soon as possible to obtain the diagnosis
Sputum or bronchoscopically obtained specimens	<ul style="list-style-type: none"> • Collect expectorated specimen into sterile transport cup or collect during bronchoscopy procedure. • Transport at room temperature up to 2h • If it is known that material will be transported from 2-24 h after collection, then store and transport at 2-8°C.
Tissue specimens (biopsies, abscess aspirates) and wound swabs	<ul style="list-style-type: none"> • Tissue pieces (at least the size of a pea) should be collected and kept moist • Transport in sterile container at room temperature within 1 hour of collection • Alternatively a swab from a tissue sample can be submitted in hospital transport tube with medium to stabilize specimen (e.g. Amies charcoal).
Urine	<ul style="list-style-type: none"> • Collect at least 1 mL into leak-proof container • Transport at room temperature up to 2 h • Refrigerate 2 up to 24 h until culture inoculation

MICROSCOPY CHARACTERISTICS

GRAM STAIN

- Small, straight, or slightly curved Gram negative rods (2-5 x 0.4-0.8 μm)
- Smooth form arranged in long, parallel bundles
- Rough form arranged irregularly
- Bipolar staining

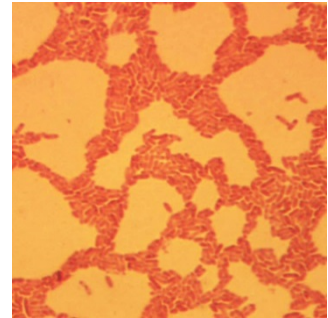

COLONY MORPHOLOGY

- Smooth, creamy white colonies on Sheep Blood agar (BAP) and Chocolate agar (CHOC) at 24 h; may display metallic sheen on BAP and CHOC at 48 h; some colonies become either mucoid or dry and wrinkled after 48-72 h; no violet pigment
- Pink on MAC/EMB agar at 24-48 h due to oxidation of lactose not fermentation

COLONY GROWTH

- Heavy at 42°C at 48 h
- Resistant to colistin and polymyxin B
- Resistant to penicillin
- Susceptible to amoxicillin/clavulanic acid
- No pigment on MH agar
- Distinctive musty or earthy odor (DO NOT SNIFF PLATE)



24 HOURS ON BAP



24 HOURS ON CHOC



48 HOURS ON BAP



48 HOURS ON CHOC



72 HOURS ON BAP



72 HOURS ON CHOC

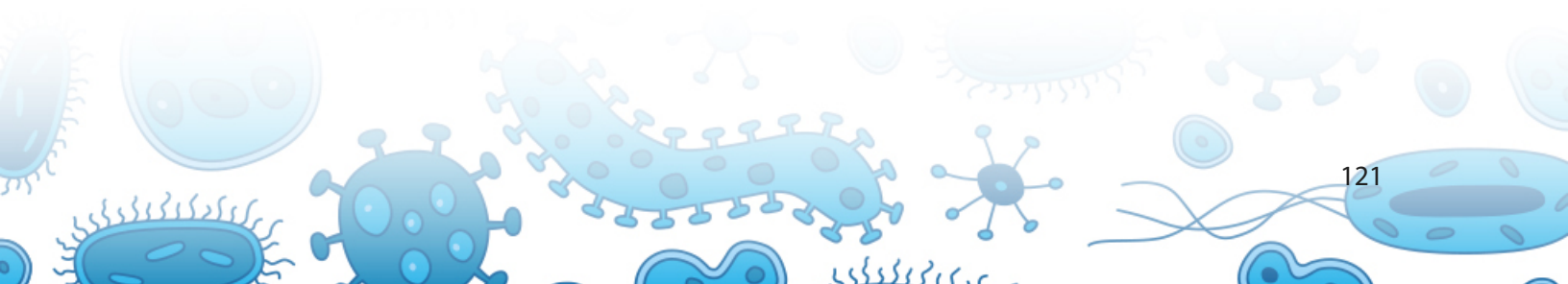

24 HOURS ON MAC

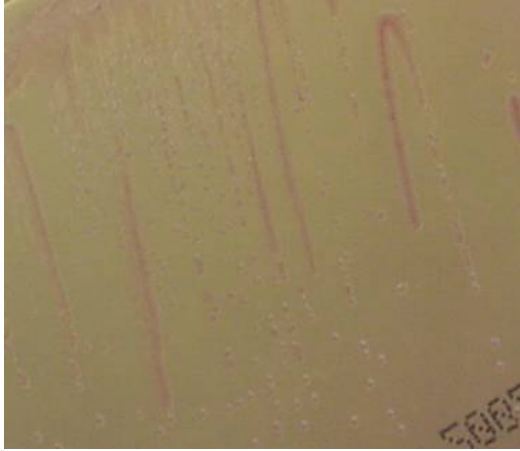

48 HOURS ON MAC

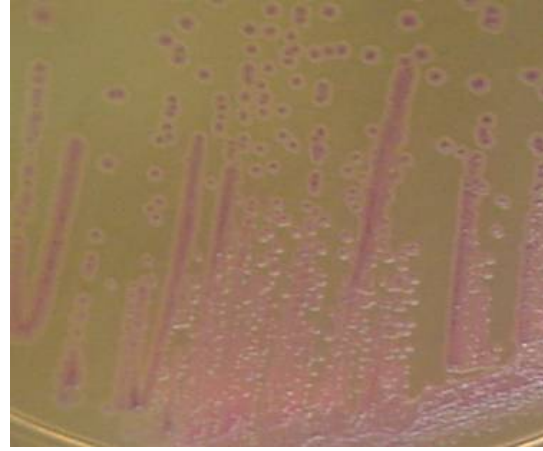

BIOCHEMICAL PROFILE AND ORGANISM CHARACTERISTICS

WARNING: Using automated systems, including Mass Spectrometry (MALDI-TOF) technology may result in exposure to dangerous pathogens, and could result in erroneous identification, e.g., *Bacillus anthracis* misidentified as *B. cereus*; *Yersinia pestis* misidentified as *Y. pseudotuberculosis*.

MALDI-TOF IDENTIFICATION

If your laboratory uses mass spectrometry (MALDI-TOF) for bacterial identification, and if the manufacturer provides your facility with an alternate tube extraction method, it is recommended that the resulting extract be filtered using a 0.2 µm (or less) filter. This additional step is recommended to reduce the chance of laboratory contamination with viable bacteria and spores.

BIOCHEMICAL TESTS TO BE PERFORMED INCLUDE:

CATALASE

Warning! For safety purposes, it is recommended that this test be performed in a BSC, covered petri dish or tube to ensure the containment of aerosols that are produced when the test organism generates a positive result (production of bubbles).

Burkholderia pseudomallei is catalase positive (+).

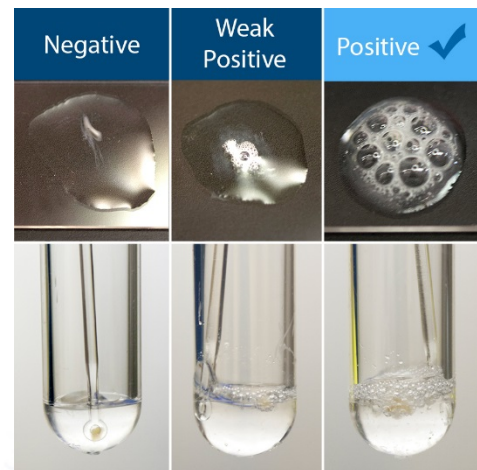

INDOLE

Burkholderia pseudomallei is indole negative (-).

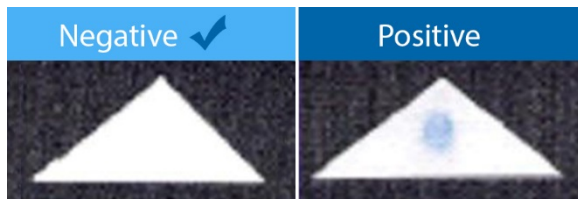

MOTILITY

Use Motility Test Medium with 2,3,5-triphenyltetrazolium chloride (TTC).

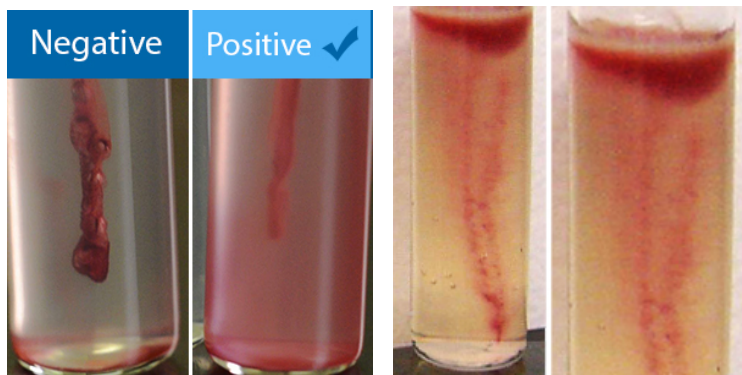

Burkholderia pseudomallei is motile (+).

OXIDASE

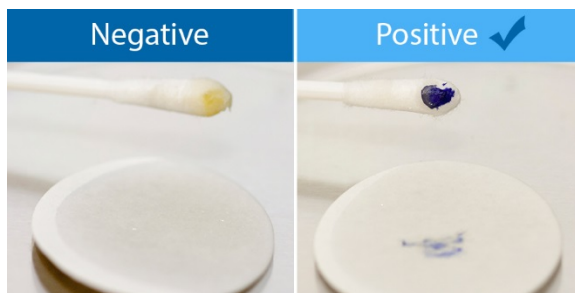

Burkholderia pseudomallei is oxidase positive (+).

ADDITIONAL SCREENING TEST ARGININE DIHYDROLASE (DECARBOXYLASE):

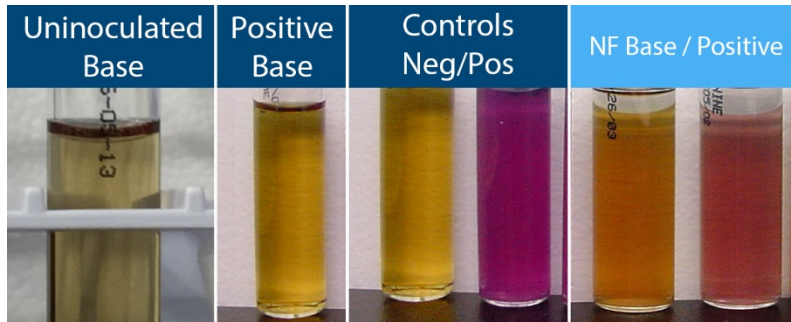

Burkholderia pseudomallei is arginine positive. (see NF Base/Positive)

POSSIBLE MISIDENTIFICATIONS

Possible Misidentifications for <i>Burkholderia pseudomallei</i> Include:	
Organism	Differential Test
<i>Burkholderia cepacia</i>	Resistant to amoxicillin-clavulanic acid, lactose fermenter (LF) on MacConkey and EMB, arginine negative
<i>Chromobacterium violaceum</i>	Hemolysis, violet pigment on BAP
<i>Pseudomonas aeruginosa</i>	Colonial morphology, grape odor (do NOT sniff plates)
<i>Pseudomonas stutzeri</i>	Arginine negative, susceptible to polymyxin B
<i>S. maltophilia</i>	Arginine negative

LABORATORY TESTING INFORMATION

Refer to the ASM Sentinel Level Clinical Laboratory Protocols for more detailed information: <http://www.asm.org/index.php/science-skills-in-the-lab/sentinel-guidelines>. For additional testing information, please contact your local LRN Reference Laboratory.

RULE-OUT FLOWCHART

If you see the following characteristics:

- Gram negative coccobacilli from specimens that may demonstrate bipolar staining
- Growth of creamy white colonies at 48 hours on BAP
- May display metallic sheen on BAP and Chocolate at 48 h
- Growth on MAC in 48 h
- Motile
- Non-hemolytic
- Oxidase (+), Catalase (+), Indole (-)
- May have musty odor (**Not all *B. pseudomallei* have the characteristic odor, which cannot be used to rule out the organism**)
- And cannot rule out *Burkholderia pseudomallei* using the protocol flow chart...

Then you cannot rule out *B. pseudomallei*

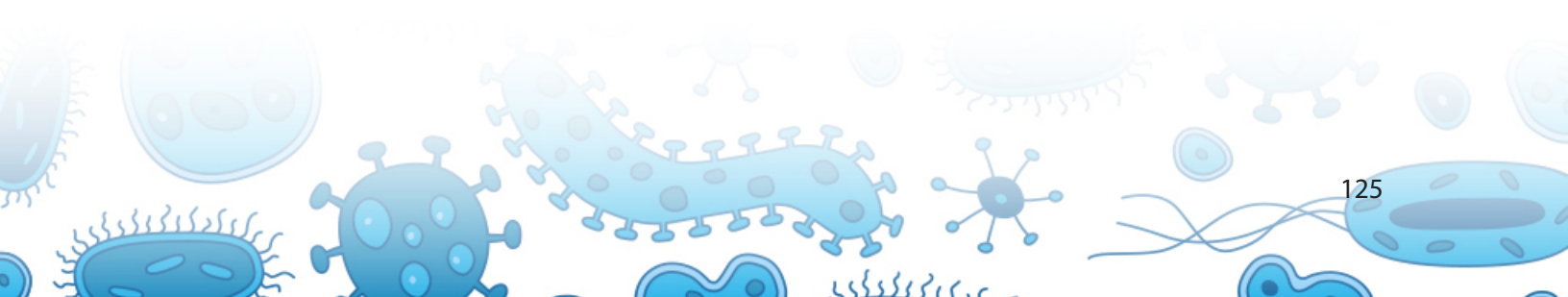

BURKHOLDERIA PSEUDOMALLEI IDENTIFICATION FLOWCHART

SAFETY: As soon as *Burkholderia* is suspected, perform ALL further work in a Class II BSC using BSL-3 practices.

Major characteristics of *Burkholderia pseudomallei*:

Gram stain morphology: Gram negative rod, straight or slightly curved, may demonstrate bipolar morphology at 24 h and peripheral staining, like endospores, as cultures age

Colony morphology: Poor growth at 24 h, good growth of smooth, creamy colonies at 48 h on BAP; may develop wrinkled colonies in time, nonhemolytic. Can demonstrate strong characteristic musty, earthy odor; growth on MAC/EMB in 48 h, no pigment is visible on Mueller-Hinton agar, may have non-violet pigment on BAP.

Reactions: Oxidase positive; indole negative

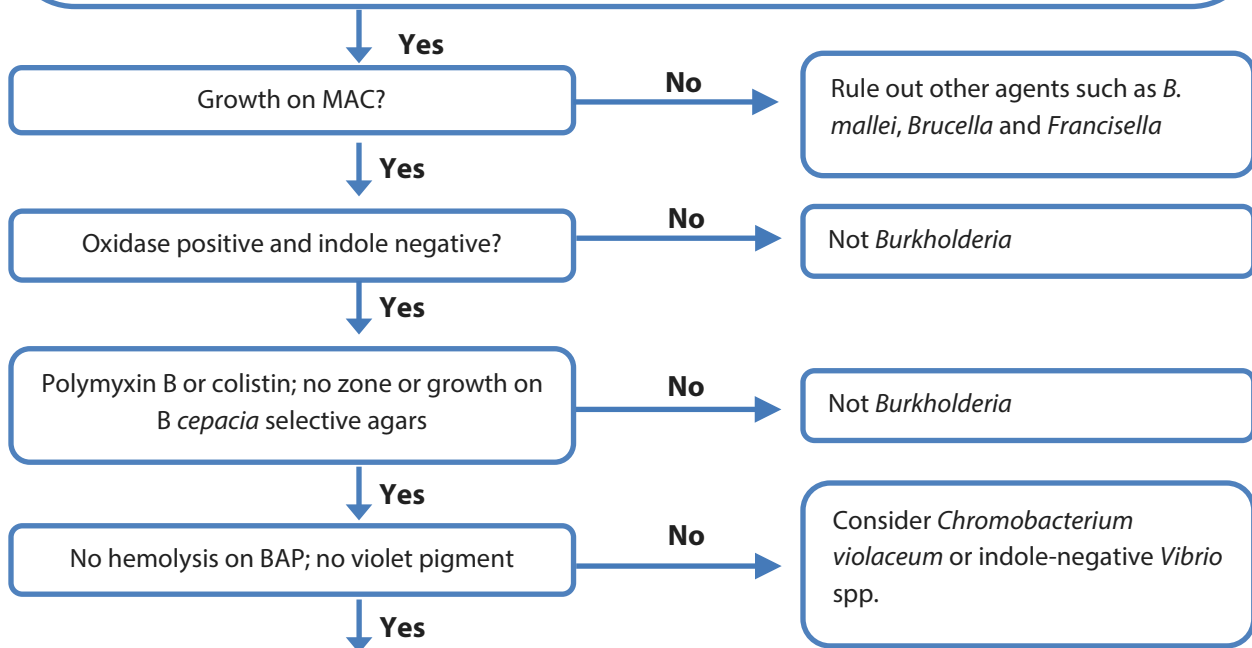

B. pseudomallei not ruled out, especially if colonies have musty odor.
B. pseudomallei is separated from *B. cepacia* by a susceptible amoxicillin-clavulanate test. Although rare in *B. pseudomallei*, resistance cannot rule out the identification.
Contact your LRN Reference Level Laboratory to refer isolate.

Report: Possible *Burkholderia pseudomallei* submitted to LRN Reference Laboratory.

Additional screening test: *B. pseudomallei* and *B. mallei* are arginine positive, unlike other *Burkholderia*.
(Test can be in kit identification systems.)

Unlike *B. mallei*, *B. pseudomallei* grows at 42°C in 48 h and is motile.

Refer the Patient Specimen or Isolate to your local LRN Reference Laboratory

If the organism cannot be ruled out then you must secure all of the plates, tubes, bottles, slides, and clinical specimens in case the isolate is confirmed as a select agent. Please refer to the *Burkholderia pseudomallei* identification flow chart and bench card.

REPORTING AND NOTIFICATION TO STATE OR LOCAL PUBLIC HEALTH

Suspect cases should be immediately reported to the local health department for investigation. Prior to submitting specimens for testing, your LRN Reference Laboratory must be contacted for specimen submission guidance and to provide test notification. For confirmed cases, clinical laboratories must always refer to their State / Local and Federal disease notification and reporting requirements. See your state specific contact information in the State Section and the following link for Federal guidelines. <http://www.selectagents.gov/>

SHIPPING AND TRANSFERS

Upon notification to the local health department epidemiology program and coordination with your local Public Health LRN Reference Laboratory of suspected *Burkholderia pseudomallei*, laboratories should be prepared to properly package and ship the sample(s). If a culture is being submitted for LRN Rule-Out Testing, the shipment should be classified, handled, packaged and transported as "Suspected Category A." Please note that an organism with a confirmed select agent identification will require a CDC/APHIS Form 2 for transfer. See the *Packaging and Shipping* Section contained within this guidance manual for additional information about sample classification and shipping procedures.

DESTRUCTION AND DECONTAMINATION

The Public Health Agency of Canada has created Pathogen Safety Data Sheets for numerous human pathogens. These technical documents are intended to describe the hazardous properties of listed organisms and recommendations for work involving these agents in a laboratory setting. A complete list of the organisms as well as other safety related information is available here:

<http://www.phac-aspc.gc.ca/lab-bio/res/psds-ftss/index-eng.php>.

The Pathogen Safety Data Sheet for *Burkholderia pseudomallei* is available here:

<http://www.phac-aspc.gc.ca/lab-bio/res/psds-ftss/msds26e-eng.php>

If the identification is confirmed then you must either transfer or destroy all remaining materials, isolates, patient samples, etc. within 7 days. Refer to the Biosafety, Biosecurity and Regulations section for directions on how to destroy, secure, or transfer the agent (See [DecontaminationSelectAgents_JobAid_10_06_2015_Final_Job_Aid](#)). Work with your LRN Reference Laboratory on how to fill out the required paperwork.

EXPOSURES / MEDICAL/ CASE DEFINITION

When a melioidosis infection is diagnosed, the disease can be treated with the use of appropriate medication. The type of infection and the course of treatment will impact long-term outcome. Treatment generally starts with intravenous (within a vein) antimicrobial therapy for 10-14 days, followed by 3-6 months of oral antimicrobial therapy. For current treatment recommendations, please see <http://www.cdc.gov/melioidosis/>

For case definition of melioidosis, please see <http://wwwn.cdc.gov/nndss/conditions/melioidosis/case-definition/2012/>

Any potential exposures require completion of CDC-APHIS Form 3. Refer to the Biosafety, Biosecurity, and Regulations Section for more information and guidance ([Form 3: APHIS/CDC Select Agent Job Aid](#)) or the Select Agent website (<http://www.selectagents.gov/form3.html>). You can also contact your LRN Reference Laboratory for assistance.

REFERENCES

ASM Guidelines: *Burkholderia pseudomallei*
<http://www.asm.org/index.php/science-skills-in-the-lab/sentinel-guidelines>

Pathogen Safety Data Sheet: *Burkholderia pseudomallei*
<http://www.phac-aspc.gc.ca/lab-bio/res/psds-ftss/msds26e-eng.php>

Biosafety in Microbiological and Biomedical Laboratories (BMBL)
<http://www.cdc.gov/biosafety/publications/bmb15/>

Melioidosis Information
<http://www.cdc.gov/melioidosis/>



Francisella tularensis (TULAREMIA)

RECOMMENDATIONS FOR SAFE LABORATORY PRACTICES

F. tularensis is a highly virulent bacterium (infectious dose is 10 – 50 cells) and is a highly infectious pathogen. Human clinical specimens (not cultures/isolates) suspected of containing *F. tularensis* can be processed with BSL-2 practices.

If the initial Gram stain and/or culture is suggestive of *F. tularensis*, all manipulation should be performed in a biological safety cabinet (BSL-2) with BSL-3 practices.

Suspected *F. tularensis* manipulation should be performed in a biological safety cabinet (BSL-2) with BSL-3 practices.

Nonclinical (environmental or animal) samples or specimens should not be processed in hospital laboratories. Veterinary laboratories are equipped to handle animal specimens. Nonclinical specimens should be directed to the designated LRN Reference Laboratory.

Refer to the Biosafety, Biosecurity and Regulations section contained within this guidance

manual, the Biosafety in Microbiological and Biomedical Laboratories (BMBL) (<http://www.cdc.gov/biosafety/publications/bmb15/>) and Guidelines for Safe Work Practices in Human and Animal Medical Diagnostic Laboratories (<http://www.cdc.gov/mmwr/preview/mmwrhtml/su6101a1.htm>) for more information.

DISEASE TRANSMISSION AND CLINICAL PRESENTATION

<http://www.cdc.gov/tularemia/laboratoryexposure/>

F. tularensis is a zoonotic pathogen that is widespread throughout the Northern Hemisphere and is responsible for recent tularemia outbreaks in several countries including Norway and Turkey.

Within the United States, tularemia has been reported in every state with the exception of Hawaii and approximately 120 cases are reported a year.

F. tularensis is a zoonotic pathogen with an extremely wide host range that includes mammals, birds and amphibians. The primary hosts for *F. tularensis* are believed to be small rodents (hares, voles, muskrats).

<http://www.cdc.gov/tularemia/>

- Bite of an infected arthropod.
- Ticks, deer fly, horse fly and mosquitoes.

DATE APPROVED:

8 / 1 / 2016

SAFETY CONSIDERATIONS:

As soon as *Francisella tularensis* is suspected in the laboratory, perform ALL further work within in containment such as within a Class II Biological Safety Cabinet (BSC) and follow BSL-3 practices.

- Contact with infected animal or carcasses.
- Ingestion of contaminated food or water.
- Inhalation of infectious aerosols.

The signs and symptoms of tularemia vary depending on how the bacterium enters the body. Illness ranges from mild to life-threatening. All forms are accompanied by fever, which can be as high as 104 °F.



- **Ulceroglandular** This is the most common form of tularemia and usually occurs following a tick or deer fly bite or after handling of an infected animal. A skin ulcer appears at the site where the organism entered the body. The ulcer is accompanied by swelling of regional lymph glands, usually in the armpit or groin.
- **Glandular** Similar to ulceroglandular tularemia but without an ulcer. Also generally acquired through the bite of an infected tick or deer fly or from handling sick or dead animals.
- **Oculoglandular** This form occurs when the bacteria enter through the eye. This can occur when a person is butchering an infected animal and touches his or her eyes. Symptoms include irritation and inflammation of the eye and swelling of lymph glands in front of the ear.
- **Oropharyngeal** This form results from eating or drinking contaminated food or water. Patients with oropharyngeal tularemia may have sore throat, mouth ulcers, tonsillitis, and swelling of lymph glands in the neck.
- **Pneumonic** This is the most serious form of tularemia. Symptoms include cough, chest pain, and difficulty breathing. This form results from breathing dusts or aerosols containing the organism. It can also occur when other forms of tularemia (e.g. ulceroglandular) are left untreated and the bacteria spread through the bloodstream to the lungs.

ACCEPTABLE SAMPLE TYPES

<http://www.asm.org/index.php/science-skills-in-the-lab/sentinel-guidelines>

Collection and Transport of Clinical Specimens for Laboratory Rule-Out Testing	
<p>Tissue Biopsy, scraping of an ulcer, or conjunctival swab</p>	<ul style="list-style-type: none"> • For small tissue samples, add several drops of sterile normal saline into a sterile container to keep the tissue moist • Transport at room temperature for immediate processing • If processing of specimen is delayed beyond 2 hours, keep specimen chilled (2-8°C) • Amies transport media is an appropriate transport medium
<p>Aspirate Lymph node or lesion</p>	<ul style="list-style-type: none"> • Submit in a sterile container • Transport at room temperature for immediate processing. • If processing of specimen is delayed beyond 2 hours, keep specimen chilled (2-8°C)
<p>Bone Marrow</p>	<ul style="list-style-type: none"> • Submit in a sterile container • Transport at room temperature for immediate processing • If processing of specimen is delayed beyond 2 hours, keep specimen chilled (2-8°C)
<p>Blood</p>	<ul style="list-style-type: none"> • Transport inoculated bottles directly to laboratory at room temperature • Hold at room temperature until placed into automated, continuous monitoring blood culture incubators • Do not refrigerate
<p>Respiratory Secretions</p>	<ul style="list-style-type: none"> • Submit in a sterile container • Transport at room temperature for immediate processing • If processing of specimen is delayed beyond 2 hours, keep specimen chilled (2-8°C)
<p>Serum</p>	<ul style="list-style-type: none"> • Collect at least 1 mL without anticoagulant for serologic diagnosis • Store at 4°C until testing is performed. • Acute specimen is collected as soon as possible after onset of disease • Convalescent-phase should be collected >14 days after the acute specimen.

MICROSCOPY CHARACTERISTICS

GRAM STAIN

- Pleomorphic, minute (0.2 - 0.5 μm x 0.7 - 1.0 μm) faintly staining, Gram negative coccobacillus.
- May stain weakly.
- Often difficult to see individual cells.

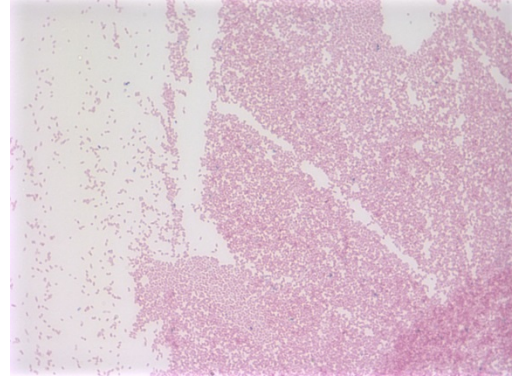

COLONY MORPHOLOGY AND GROWTH CHARACTERISTICS

- Tiny, grey-white, and opaque on Sheep Blood agar (BAP), Chocolate agar (CHOC), Thayer-Martin agar (TM), and BCYE agar. Smooth, shiny, and butyrous.
- Scant to no growth on Sheep Blood agar after 48hrs. Usually too small to be seen at 24hrs.
- Grows better on Chocolate agar.
- No growth on MacConkey (MAC) or EMB agar.
- Slow growth in broth. Requires Cysteine supplementation.
- Grows poorly on BAP initially, or not at all when subcultured. Cysteine-enriched media such as CHOC, TM, BCYE, thioglycollate broth will help support subculture.

COLONIES ON BAP

24 hours on BAP

- After 18 to 24 h: pin-point, translucent colonies usually too small to be seen individually.

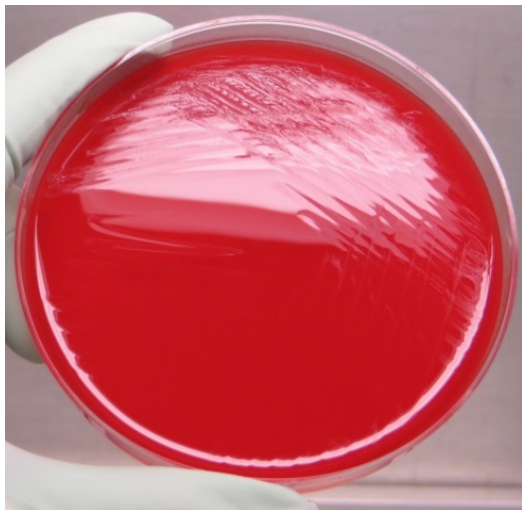

48 hours on BAP

- After 48 h: <1 mm, gray-white, opaque, no hemolysis.

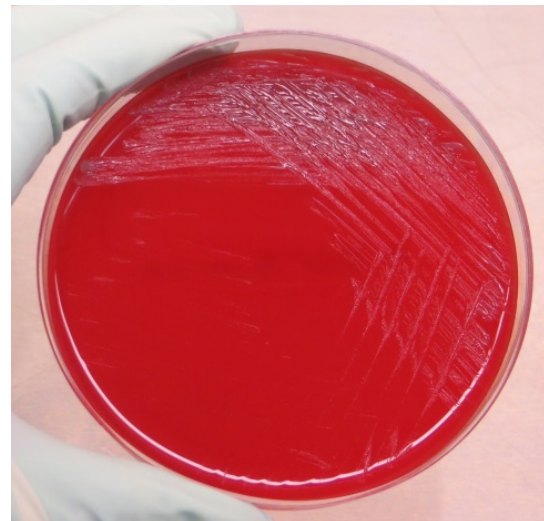

72 hours on BAP

- After 72 h: similar to 48 h but a bit larger.

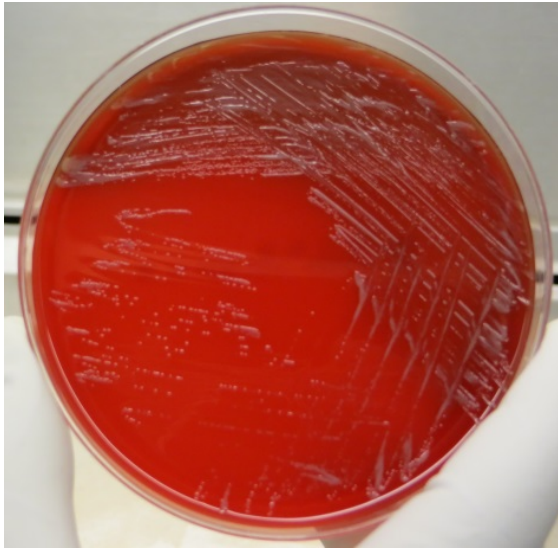

COLONIES ON CHOC

24 hours on CHOC

48 hours on CHOC

72 hours on CHOC

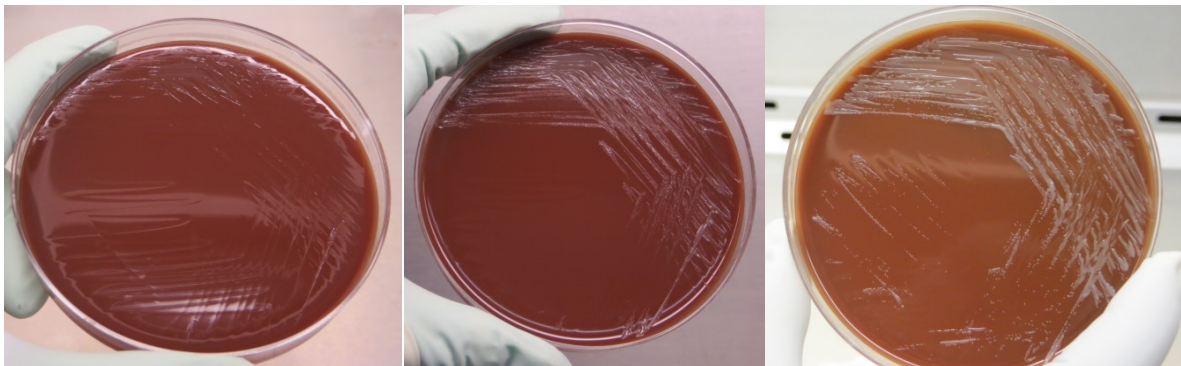

- After 48 h, 1-2 mm white to grey to bluish grey, opaque flat with smooth and shiny surface.



Colonies on BCYE



No growth on MAC

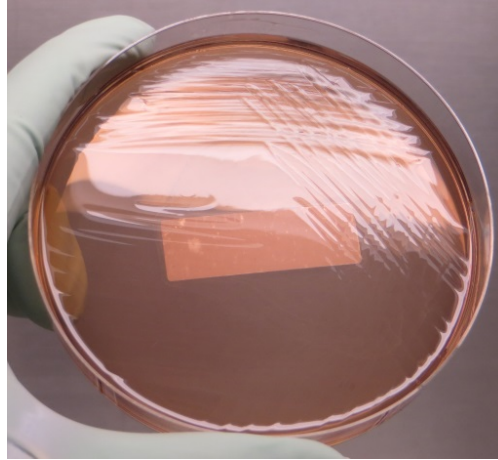

S. AUREUS SATELLITE ON BAP

No satelliting of growth around *S. aureus* on BAP is negative (-) for *F. tularensis*. Does not require X and V factors.

If you see satelliting growth, consider *Haemophilus*.



F. tularensis satellite test negative

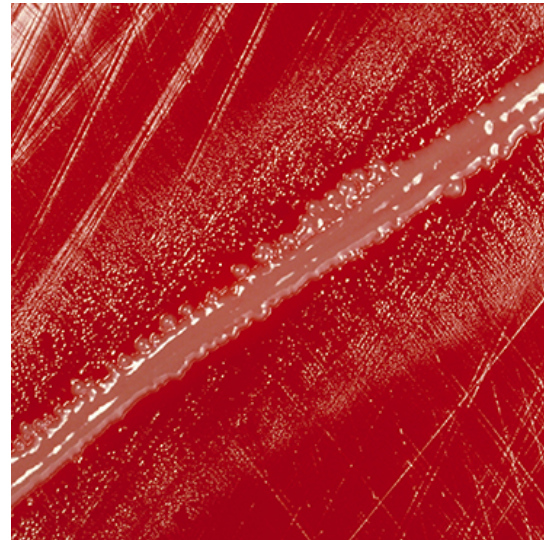

H. influenzae satellite test positive

BIOCHEMICAL PROFILE AND KEY ORGANISM CHARACTERISTICS

WARNING: Using automated systems, including Mass Spectrometry (MALDI-TOF) technology may result in exposure to dangerous pathogens, and could result in erroneous identification, e.g., *Bacillus anthracis* misidentified as *B. cereus*; *Yersinia pestis* misidentified as *Y. pseudotuberculosis*.

MALDI-TOF IDENTIFICATION

If your laboratory uses mass spectrometry (MALDI-TOF) for bacterial identification, and if the manufacturer provides your facility with an alternate tube extraction method, it is recommended that the resulting extract be filtered using a 0.2 μm (or less) filter. This additional step is recommended to reduce the chance of laboratory contamination with viable bacteria and spores.

CATALASE TEST

Warning! For safety purposes, it is recommended that this test be performed in a BSC, covered petri dish or tube to ensure the containment of aerosols that are produced when the test organism generates a positive result (production of bubbles).

F. tularensis is catalase negative (-) or weakly positive (+).

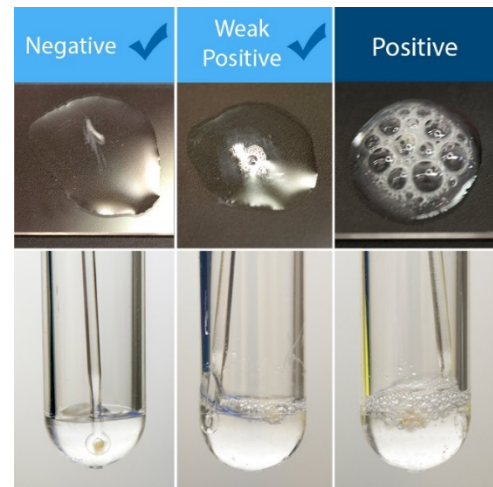

OXIDASE TEST

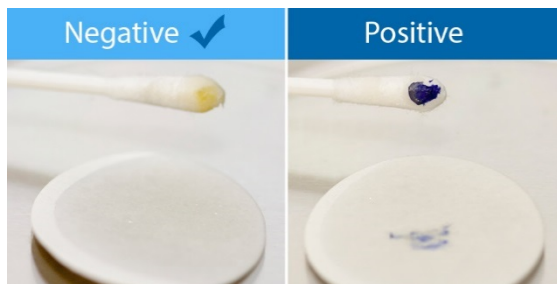

F. tularensis is oxidase negative (-).

β -LACTAMASE TEST

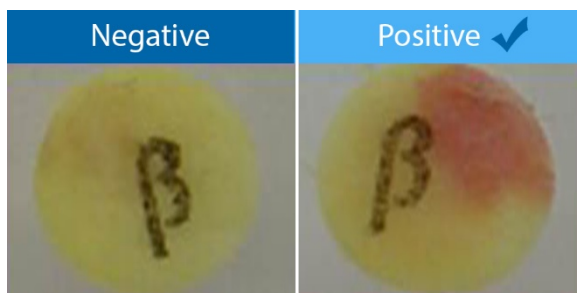

F. tularensis is beta-lactamase positive (+).



POSSIBLE MISIDENTIFICATIONS FOR *F. TULARENSIS* IN THE LAB:

Possible Misidentifications for <i>F. tularensis</i> include:	
Organism	Differential Test
<i>Acinetobacter</i> spp.	MAC positive, oxidase positive
<i>Aggregatibacter</i> spp.	Catalase, positive β -lactamase, negative
<i>Haemophilus</i> spp.	Oxidase positive, requires X & V factors
<i>H. influenzae</i>	Satellite or XV positive
<i>Bordetella</i> Grp. IV	Inert, urea positive
<i>Pasturella</i> spp	Non-sticky, MAC positive
<i>Dysgonomonas</i> spp.	Colonies measure 1 to 2 mm in diameter after 24 h of growth, have a distinct strawberry-like odor
<i>Brucella</i> spp.	Oxidase, urea and catalase positive
<i>Psychrobacter phenylpyruvicus</i>	Oxidase positive
<i>Oligella ureolytica</i>	Oxidase positive

LABORATORY TESTING INFORMATION

Refer to the ASM Sentinel Level Clinical Laboratory Protocols for more detailed information: <http://www.asm.org/index.php/science-skills-in-the-lab/sentinel-guidelines>. For additional testing information, please contact your local LRN Reference Laboratory.

RULE-OUT FLOWCHART

If you see:

- Tiny, Gram negative coccobacilli from blood, lymph node aspirate, skin ulcer, or respiratory specimens,
- Slow growth on chocolate agar, poorly or not at all on blood agar at 72 hours,
- No growth on MAC,
- Oxidase (-), Catalase (-) or weak (+), beta-lactamase (+), satellite (-),

Then you cannot rule out *F. tularensis*

Francisella tularensis IDENTIFICATION FLOWCHART

SAFETY: As soon as *Francisella* is suspected, perform ALL further work in a Class II BSC using BSL-3 practices.

Major characteristics of *Francisella tularensis*

Gram stain morphology: Pleomorphic, minute (0.2 to 0.5 by 0.7 to 1.0 μm) faintly staining, Gram negative coccobacillus

Colony morphology: No growth on MAC/EMB, scant to no growth on BAP after > 48 h. Produces 1-2 mm gray to grayish-white colonies on CHOC after > 48 h

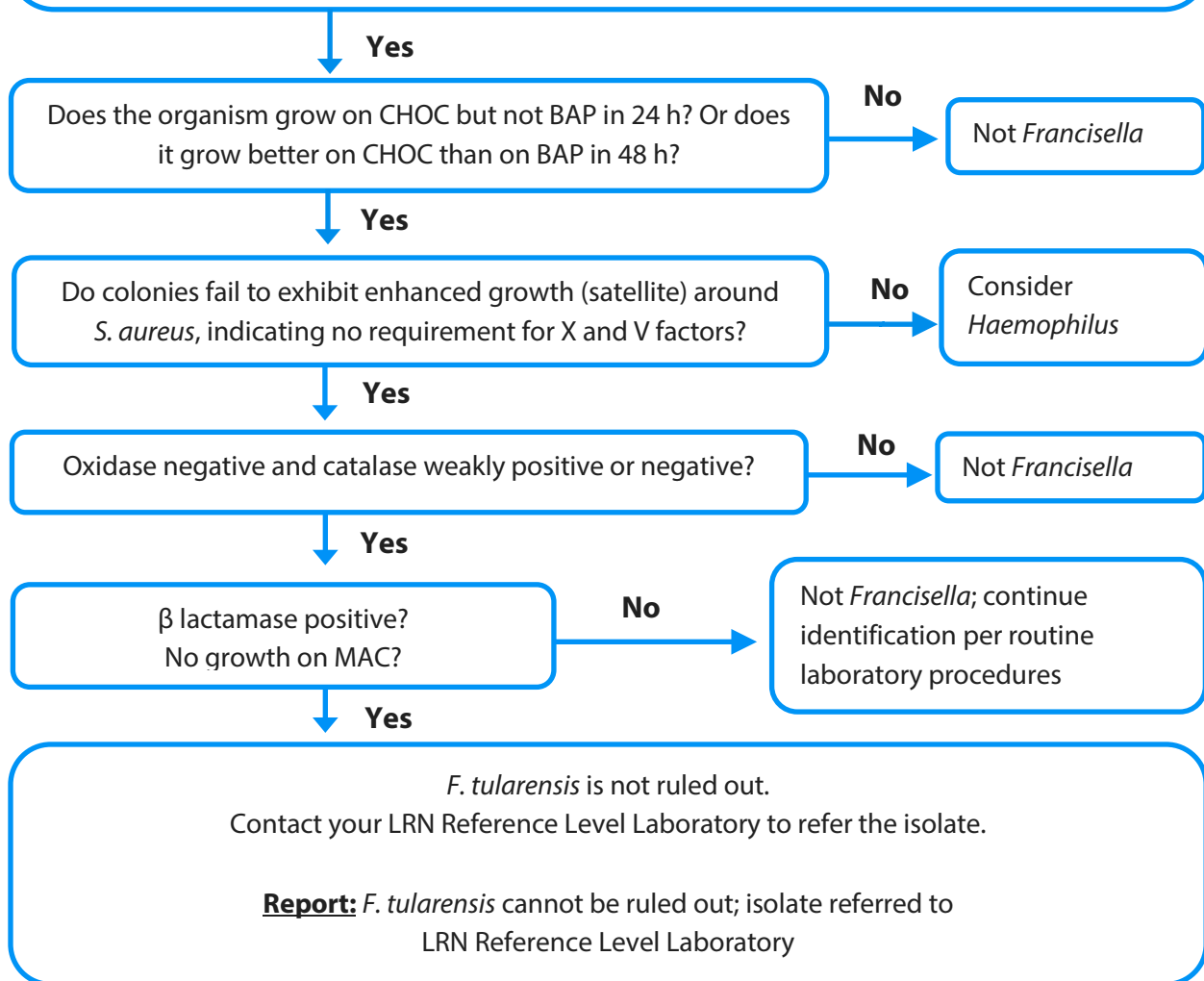

WARNING: Automated identification systems may key out as non-*F. tularensis* (e.g. *Haemophilus influenzae* and *Aggregatibacter*)

ASM, 3/30/16

Refer the Patient Specimen or Isolate to your local LRN Reference Laboratory

If the organism cannot be ruled out then you must secure all of the plates, tubes, bottles, slides, and clinical specimens in case the isolate is confirmed as a select agent.

REPORTING AND NOTIFICATION TO STATE OR LOCAL PUBLIC HEALTH

Suspect cases should be immediately reported to the local health department for investigation. Prior to submitting specimens for testing, your LRN Reference Laboratory must be contacted for specimen submission guidance and to provide test notification. For confirmed cases, clinical laboratories must always refer to their State / Local and Federal disease notification and reporting requirements. See your state specific contact information in the State Section and the following link for Federal guidelines. <http://www.selectagents.gov/>

SHIPPING AND TRANSFERS

Upon notification to the local health department epidemiology program and coordination with your local Public Health LRN Reference Laboratory of a suspected *F. tularensis*, laboratories should be prepared to properly package and ship the sample(s). If a culture is being submitted for LRN Rule-Out Testing, the shipment should be classified, handled, packaged and transported as "Suspected Category A." Please note that an organism with a confirmed select agent identification will require a CDC/APHIS Form 2 for transfer. See the *Packaging and Shipping* Section contained within this guidance manual for additional information about sample classification and shipping procedures.

DESTRUCTION AND DECONTAMINATION

The Public Health Agency of Canada has created Pathogen Safety Data Sheets for numerous human pathogens. These technical documents are intended to describe the hazardous properties of listed organisms and recommendations for work involving these agents in a laboratory setting. A complete list of the organisms as well as other safety related information is available here:

<http://www.phac-aspc.gc.ca/lab-bio/res/psds-ftss/index-eng.php>.

If the identification is confirmed then you must either transfer or destroy all remaining materials, isolates, patient samples, etc. within 7 days. Refer to the Biosafety, Biosecurity and Regulations section for directions on how to destroy, secure, or transfer the agent (See [DecontaminationSelectAgents JobAid 10 06 2015 Final Job Aid](#)). Work with your LRN Reference Laboratory on how to fill out the required paperwork.

EXPOSURES / MEDICAL/ CASE DEFINITION

For current treatment recommendations, please see the CDC tularemia information web site: <http://www.cdc.gov/tularemia/diagnosistreatment/index.html>

Any potential exposures should be immediately reported to the local health department and will require the completion of CDC-APHIS Form 3. Refer to the Biosafety, Biosecurity, and Regulations

Section for more information and guidance ([Form 3: APHIS/CDC Select Agent Job Aid](#)) or the Select Agent website (<http://www.selectagents.gov/form3.html>). You can also contact your LRN Reference Laboratory for assistance. <http://www.cdc.gov/tularemia/laboratoryexposure/index.html>

REFERENCES

CDC Tularemia

<http://www.cdc.gov/Tularemia/>

BMBL

<http://www.cdc.gov/biosafety/publications/bmb15/>

ASM Guidelines

<http://www.asm.org/index.php/science-skills-in-the-lab/sentinel-guidelines>

Select Agent Regulations

<http://www.selectagents.gov/>



Yersinia pestis (PLAGUE)

RECOMMENDATIONS FOR SAFE LABORATORY PRACTICES

Yersinia pestis is a dangerous, highly virulent organism with a low infective dose and culture material should not be manipulated on the open bench. To avoid exposures and potential laboratory acquired infections, work with suspicious cultures in a Class II Biological Safety Cabinet using BSL-3 practices until the presence of a highly infectious agent has been ruled out.

Plague is often misdiagnosed. It occurs rarely in the U.S. even in endemic areas, has a confusing array of clinical presentations, and early stages of disease may be non-specific. The clinical laboratory rarely gets advanced warning that a specimen from a patient suspected of having plague is coming.

Watch for trigger points that may indicate the presence of *Y. pestis* and work in a BSC until it has been ruled out:

- Patient history of travel, hunting/trapping, camping, hiking or farming in, or emigration from, endemic areas.
- Patient occupation or hobby that may indicate a higher risk such as working with animals, gardener/landscaper, laboratory personnel.
- Growth from normally sterile sites (such as blood, CSF, body fluids, lymph node & other aspirates).
- Bipolar-staining gram-negative rods seen in direct Gram stain.
- Slow-growing organism, especially if no growth or poor growth on MAC.

“Sniffing” plates is dangerous and has been linked to lab-acquired infections.

Do not attempt to identify slow-growing or fastidious organisms on automated systems because of the potential for misleading/inaccurate IDs and the danger of aerosols that may cause exposures to personnel.

Refer to the Biosafety, Biosecurity, and Regulations section contained within this guidance manual, the Biosafety in Microbiological and Biomedical Laboratories (BMBL) (<http://www.cdc.gov/biosafety/publications/bmb15/>) and Guidelines for Safe Work Practices in Human and Animal Medical Diagnostic Laboratories (<http://www.cdc.gov/mmwr/preview/mmwrhtml/su6101a1.htm>) for more information.

DATE APPROVED:

8 / 1 / 2016

SAFETY CONSIDERATIONS:

As soon as *Yersinia pestis* is suspected in the laboratory, perform ALL further work within containment such as a Class II Biological Safety Cabinet (BSC) and observe and follow BSL-3 practices.

DISEASE TRANSMISSION AND CLINICAL PRESENTATION

Plague is a zoonotic disease caused by the gram-negative bacillus *Yersinia* (formerly *Pasteurella*) *pestis*, a member of the *Enterobacteriaceae*. It is endemic worldwide, including rural areas of the U.S. West and Southwest. There are 1-17 human cases per year in the U.S., almost 50% of which are from New Mexico.

Map of the U.S. showing the distribution of plague cases, 1970-2012 from <http://www.cdc.gov/plague/maps/index.html>

Reported cases of human plague--United States, 1970-2012

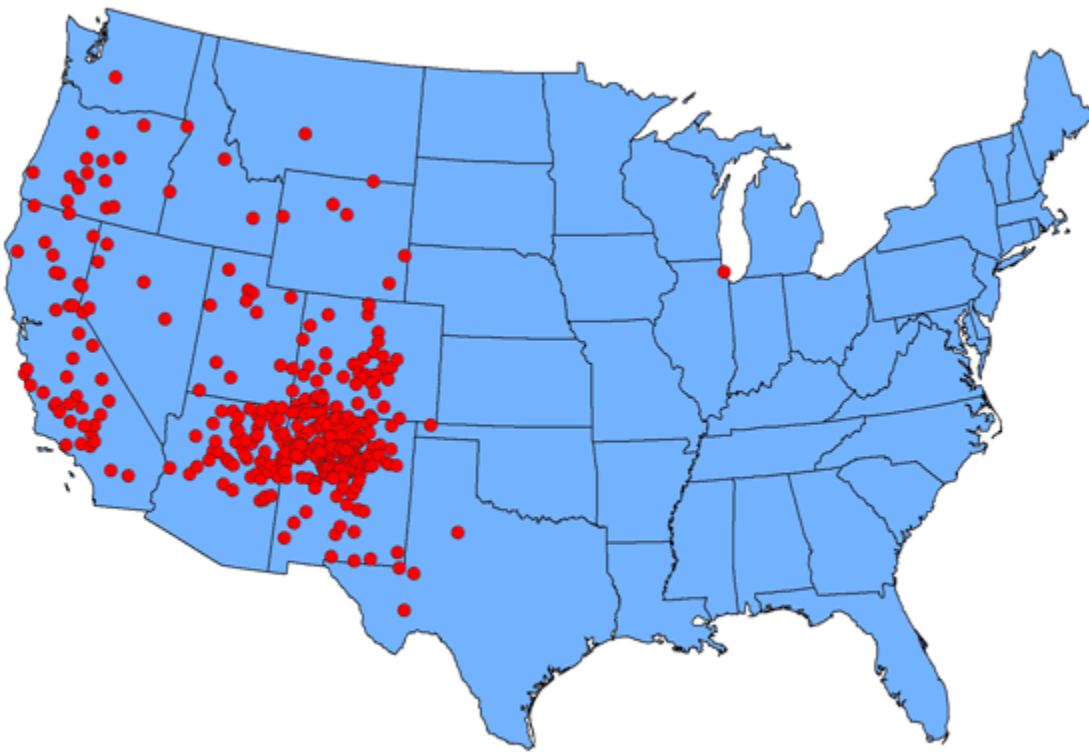

1 dot placed in county of exposure for each plague case

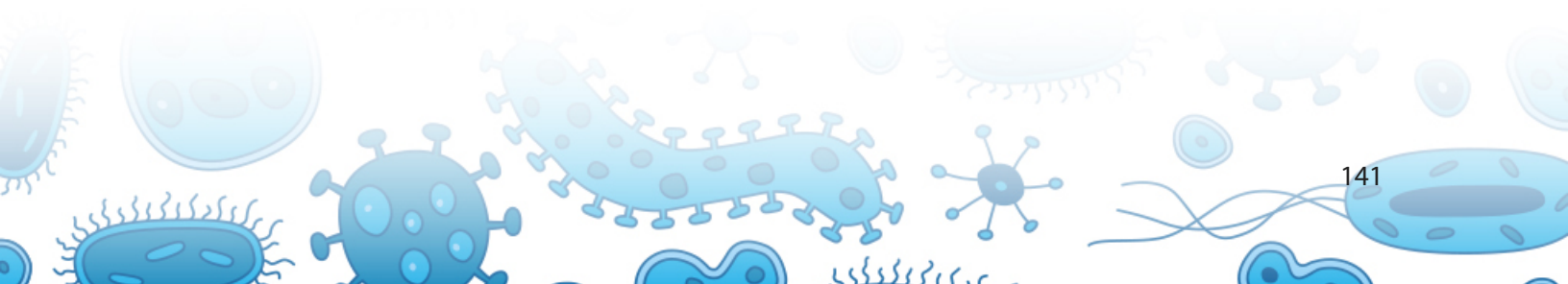

In the U.S. plague can occur year-round, but is most common in the late spring to early fall, associated with climatic and environmental conditions that allow an increase in host rodent populations and their fleas.

Host range:

- A number of species of rodent fleas act as natural vectors.
- Rodent reservoir (rock and ground squirrels, prairie dogs, chipmunks, deer mice, voles, rats, occasionally hares & rabbits).
- Most mammals, including humans and carnivores (such as bobcats, mountain lions, dogs & cats) are accidental hosts; not birds or reptiles.
- Cats & other felids are very susceptible to plague and get very ill; dogs are more resistant. Pets act as “sentinels” for human infections. They can become infected by eating dead animals and may carry infected fleas back to their human owners.
- The host & geographic range of plague overlaps with tularemia - environmental surveillance will often include both, particularly in the Southwest.

Infectious dose: unknown, but is thought to be low; perhaps as few as 100 organisms may cause infection depending on the mode of transmission.

Modes of transmission:

- Bite of infected flea
- Bite from an infected animal (especially an issue for veterinarians)
- Contact with, or ingestion of, infected fluid or tissues
- Inhalation of infectious aerosols

Communicability:

- Not usually transmissible from person-to-person except in pneumonic form (the most likely bioterrorism scenario)
- Animal-to-person infections have occurred via infected droplets or bites (sick cats)



Thrassis bacci 41 days after infection with *Yersinia pestis*

Thrassis bacci, a ground squirrel flea found inhabiting the United States, is one of the primary rodent flea vectors of plague to humans.

During feeding, the flea draws viable *Y. pestis* organisms into its esophagus, which multiply and block the proventriculus just in front of the stomach, later forcing the flea to regurgitate infected blood into the host when it tries to swallow.

Signs and Symptoms/Clinical Presentation:

- Depends on mode of transmission
- Can be confusing to clinician, may be non-specific in early stages, often misdiagnosed

Bubonic

- Transmitted by the bite of an infected flea or exposure to infected material via a wound or break in the skin
- 2-6 day incubation
- Proliferation of bacteria at inoculation site forms a vesicle or ulcer
- Bacteria are transported to local lymph nodes which become extremely painful and inflamed (bubo)
- Fever, chills, headache, malaise; sometimes nausea, vomiting, abdominal pain & diarrhea
- Most common clinical presentation of naturally-acquired disease
- Untreated mortality ~60%, prompt and appropriate antibiotic treatment can reduce it to <5%.
- Untreated bubonic plague can progress to secondary septicemic if bacteria are able to invade the bloodstream
- Not transmitted person-to-person

Septicemic

- Primary
 - Results from contact with, or being bitten by, an infected animal
 - The plague bacillus is directly inoculated into the bloodstream via a bite, wound or break in the skin
 - No buboes may be evident
- Secondary
 - Results from bubonic or pneumonic plague as organisms are spread through the bloodstream
- Initial fever, chills, headache, malaise
- Bacterial endotoxin production leads to multiple organ failure, disseminated intravascular coagulation (DIC) and respiratory distress
- Petechiae, necrosis and gangrene of the extremities (“the black death”)
- May progress to secondary pneumonic plague as bacteria spread to the lungs through the bloodstream
- Untreated mortality ~100%
- Not transmitted person-to-person

Pneumonic

- Primary
 - Results from inhalation of plague bacteria
 - 1-4 day incubation
 - Least common form of natural infection



- Most probable presentation if intentional release as an aerosol
- Secondary
 - Results from spread through the bloodstream of bacteria from untreated bubonic or septicemic plague
- Fever, chills, headache, malaise, dyspnea, hemoptysis
- Rapidly fatal (<24 hours, ~100% mortality) if untreated
- May be transmitted person-to-person, or animal-to-person, extremely contagious

Bubonic Plague



Septicemic Plague



Pneumonic Plague

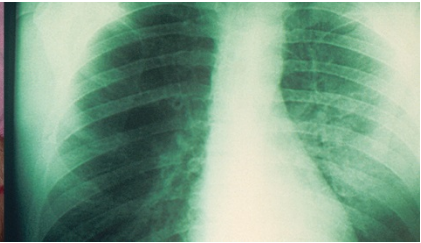

ACCEPTABLE SAMPLE TYPES

For a complete list of specimen types and their collection and handling go to <http://www.asm.org/index.php/science-skills-in-the-lab/sentinel-guidelines>:

- The “Specimen collection/handling for suspected Tier 1 BT agents” table in ASM’s Clinical Laboratory Bioterrorism Readiness Plan
- ASM’s Sentinel Level Clinical Laboratory Guidelines for *Yersinia pestis*

Collection and Transport of Clinical Specimens for Laboratory Rule-Out Testing	
Lower respiratory tract	<ul style="list-style-type: none"> ● Transport specimens in sterile, screw-capped containers at room temperature. ● If it is known that material will be transported from 2-24 h after collection, then store and transport at 2-8°C
Blood	<ul style="list-style-type: none"> ● Transport samples directly to the laboratory at ambient temperature and place onto the blood culture instrument ● Do not refrigerate ● Follow established laboratory protocols for processing blood cultures
Aspirate, tissue or biopsy specimen	<ul style="list-style-type: none"> ● Submit tissue or aspirate in a sterile container. ● For small samples, add 1–2 drops of sterile normal saline to keep the tissue moist. ● Transport sample at room temperature for immediate processing. ● Keep the specimen chilled if processing will be delayed (> 2 h).

Collection and Transport of Clinical Specimens for Laboratory Rule-Out Testing	
Swabs	<ul style="list-style-type: none"> • A swab of tissue is not recommended. • However, if a swab specimen is collected, the swab should be reinserted into an appropriate transport package and sent to the laboratory at room temperature for immediate processing. Keep the specimen chilled if processing will be delayed (>2 h).

MICROSCOPY CHARACTERISTICS

- A plump, Gram negative rod (1.0-2.0 x 0.5 μm).
- Single cells or pairs; chains in liquid media.
- Bipolar staining ("safety pin") with Wayson or Wright-Giemsa stains (may be available in hematology or histology) and may occasionally be seen in Gram stained preparations; more common in direct specimen material than from culture. Bipolar staining (the ends of the cells are darker than the middle) should not be confused with the presence of spores. **Note: Although characteristic of *Y. pestis*, bipolar staining is not always observable and is not unique for *Y. pestis* (other *Yersinia* spp., *E. coli*, *Klebsiella*, *Pasteurella* and *Burkholderia* spp. may also appear bipolar, for example).**
- Broth and blood culture bottles positive for *Y. pestis* may reveal plump, bipolar rods in chains, a very unusual arrangement for a gram-negative rod. This distinctive feature can give a presumptive ID even before there is growth on solid media and should be **immediately** reported to the clinician and LRN reference lab as suspicious for *Y. pestis*.

Gram stain from culture of *Yersinia pestis*

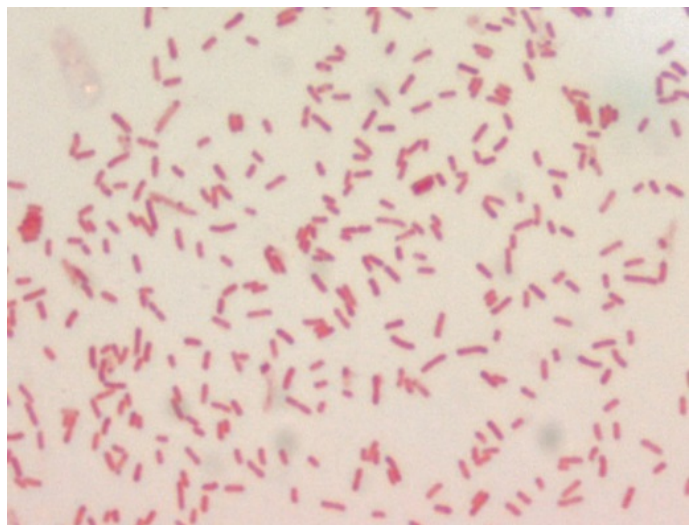

Gram stain of *Yersinia pestis* from a patient blood culture bottle

Note chaining and bipolar-staining Gram negative rods

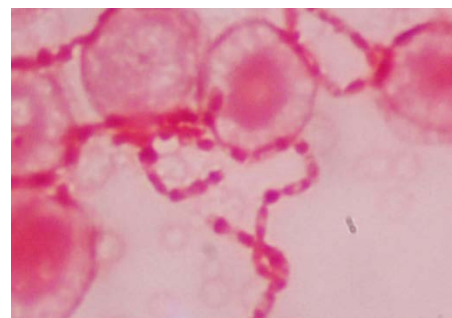

COLONY MORPHOLOGY AND GROWTH CHARACTERISTICS

- Grows well, but slowly, on most non-selective standard laboratory media (e.g., sheep blood, chocolate and tryptic soy agars).
- Grows more slowly than other *Enterobacteriaceae* at 35-37°C, but faster than most other enterics at 25-28°C (optimal but optional).
- Pinpoint, gray-white to slightly yellow, opaque, raised, little or no hemolysis at 24 hours.

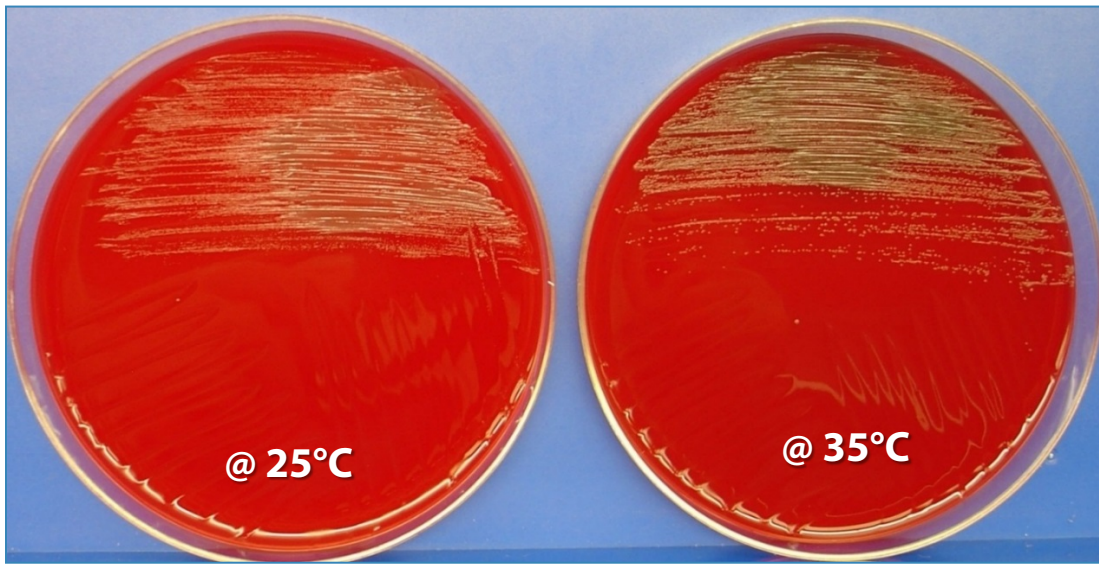

24 HOURS ON BAP at 25°C and 35°C

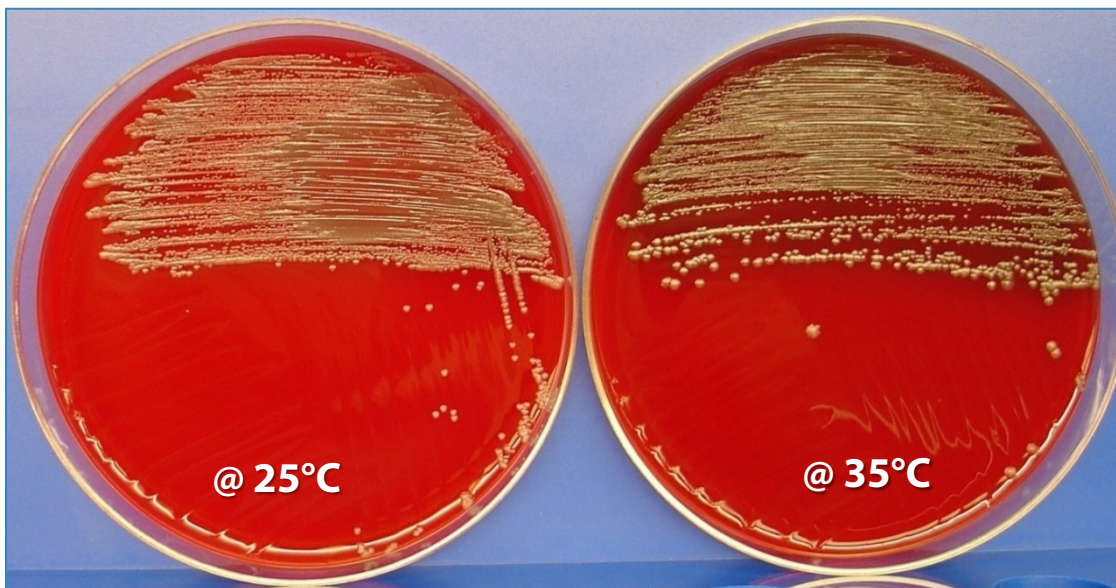

48 HOURS ON BAP at 25°C and 35°C



- After 48-72 hours colonies may have an irregular “fried egg” appearance (raised center with a flattened edge or “skirt”) and a “hammered copper” surface (best seen with oblique light under magnification).
- Older colonies are adherent & sticky, forming strands when lifted from the agar with a loop.
- Grows on MacConkey (MAC) and Eosin Methylene Blue (EMB) agar (may be delayed >24 hours), appearing as small non-lactose fermenting colonies.
- Grows well in routine blood culture systems.

72 HOURS ON BAP

Note “fried egg” appearance (raised center with irregular, flat edge or “skirt”)

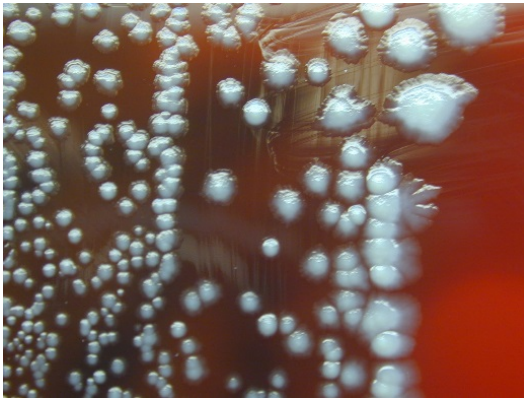

48 HOURS ON BAP

Note adherent, sticky colonies

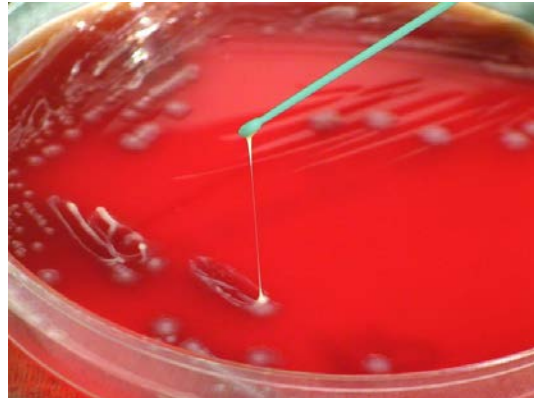

24 HOURS ON MAC

Note pinpoint, lactose-negative colonies

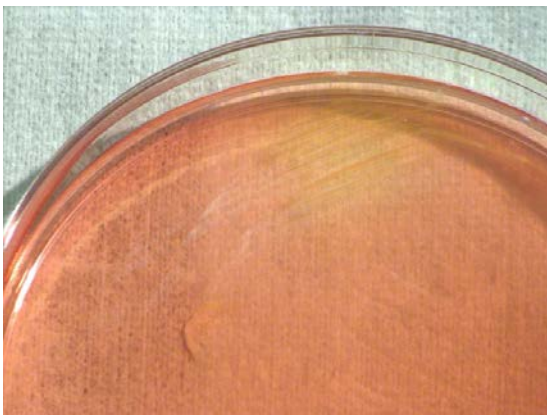

48 HOURS ON MAC

Note small, lactose-negative colonies

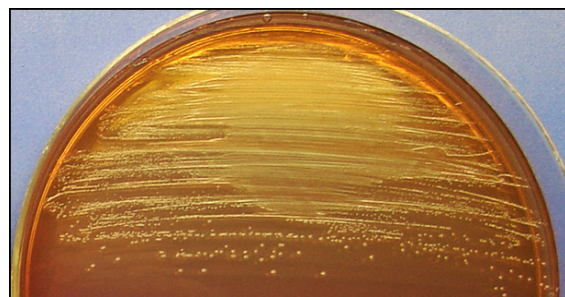

BIOCHEMICAL PROFILE AND KEY ORGANISM CHARACTERISTICS

WARNING: Using automated systems, including Mass Spectrometry (MALDI-TOF) technology may result in exposure to dangerous pathogens, and could result in erroneous identification, e.g., *Bacillus anthracis* misidentified as *B. cereus*; *Yersinia pestis* misidentified as *Y. pseudotuberculosis*.

MALDI-TOF IDENTIFICATION

If your laboratory uses mass spectrometry (MALDI-TOF) for bacterial identification, and if the manufacturer provides your facility with an alternate tube extraction method, it is recommended that the resulting extract be filtered using a 0.2 µm (or less) filter. This additional step is recommended to reduce the chance of laboratory contamination with viable bacteria and spores.

Biochemical Tests to be performed include:

CATALASE

Warning! For safety purposes, it is recommended that this test be performed in a BSC, covered petri dish or tube to ensure the containment of aerosols that are produced when the test organism generates a positive result (production of bubbles).

Y. pestis is catalase positive (+).



OXIDASE

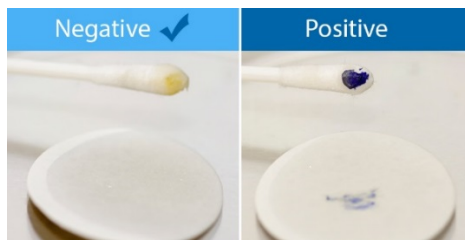

Y. pestis is oxidase negative (-).

SPOT INDOLE

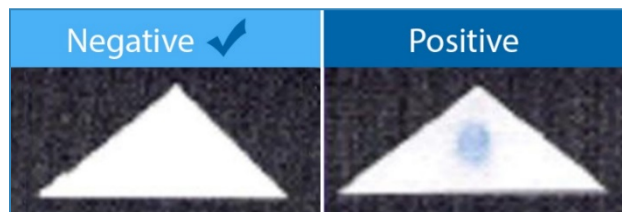

Y. pestis is indole negative (-).

UREA

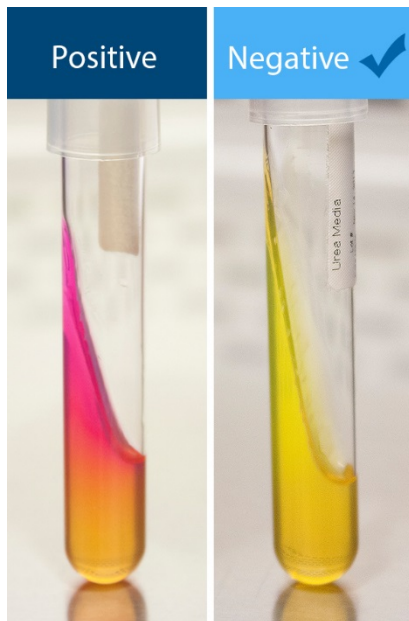

Y. pestis is urease negative (-).

POSSIBLE MISIDENTIFICATIONS

- *Yersinia pestis* is included in the databases of most enteric identification systems, but confidence may be low due to the small number of strains included.
- Automated ID systems are not generally suitable for slow-growing &/or nutritionally fastidious isolates.
- Automated systems may produce aerosols and increase the risk for laboratory acquired infection.
- An identification of *Y. pestis* must be considered presumptive until confirmed by an LRN Reference Laboratory.

Possible Misidentifications for <i>Yersinia pestis</i> Include:	
Organism	Differential Tests
<i>Acinetobacter</i> spp.	May appear as gram-negative coccobacilli, often in pairs Glucose non-fermenter Colony morphology
<i>E. coli</i> , lactose-negative	Faster growth rate Indole positive (80%) Colony morphology
<i>Pantoea</i> (formerly <i>Enterobacter</i>) <i>agglomerans</i>	Faster growth rate May produce yellow pigment ONPG positive (90%)
<i>Pasteurella multocida</i>	Faster growth rate Oxidase positive (may be weak) Indole positive Colony morphology, may appear mucoid
<i>Pseudomonas luteola</i>	May produce yellow pigment Glucose non-fermenter
<i>Pseudomonas</i> spp.	Oxidase positive (except <i>P. luteola</i> & <i>P. oryzae</i>) Glucose non-fermenter
<i>Shigella</i> spp.	Faster growth rate Colony morphology Shigella antisera
<i>Salmonella</i> spp., H ₂ S-negative	Faster growth rate Colony morphology Salmonella antisera
<i>Yersinia enterocolitica</i>	Small gram-negative coccobacilli Urease positive * Indole variable
<i>Yersinia pseudotuberculosis</i>	Urease positive*

* *Y. pseudotuberculosis* and *Y. enterocolitica* give stronger reactions in urea agar or broth when incubated at 25-28°C, but incubation at this temperature is not necessary to demonstrate urease production.

LABORATORY TESTING INFORMATION

- Since *Yersinia pestis* grows slowly, primary plates should be held for 5-7 days.
- Setting up a second set of plates and incubating them at 25-28°C may help isolate *Y. pestis* from other bacteria in mixed cultures from non-sterile sites (sputum, wounds and bites, for example) by out-competing them at the lower temperature.

- If selective and differential CIN (Cefsulodin-Irgasan-Novobiocin) agar is available (usually used to isolate *Yersinia enterocolitica*), it can also be used to separate *Y. pestis* from contaminating bacteria from non-sterile sites. *Yersinia spp.* (including *Y. pestis*) colonies will have deep-red centers surrounded by a transparent border giving the appearance of a bulls-eye.

72 HOURS ON CIN at 37°C

Note deep-red “bull’s-eye” colonies

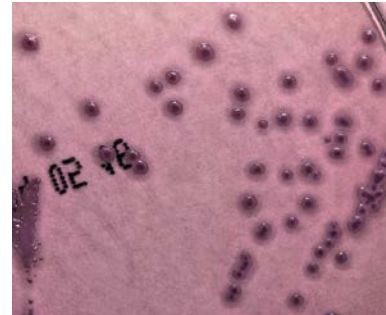

- If cultures from suspected plague cases are negative, serologic testing of paired sera (one sample from as early in the illness as possible plus a second at least 3-4 weeks later) may be available. Contact your LRN reference lab for more information.
- In coordination with the CDC and the Association of Public Health Laboratories (APHL), the ASM provides protocols designed to offer Laboratory Response Network (LRN) Sentinel Level Clinical Laboratories standardized, practical methods and techniques to rule out microorganisms suspected as agents of bioterrorism, or to refer specimens to public health laboratories for confirmation. Refer to the ASM Sentinel Level Clinical Laboratory Protocols for more detailed information: <http://www.asm.org/index.php/science-skills-in-the-lab/sentinel-guidelines>. For additional testing information, please contact your local LRN Reference Laboratory.

RULE-OUT FLOWCHART

- See the following *Yersinia pestis* Identification Flowchart for an algorithm to rule-out or refer a suspicious isolate to your LRN Reference Laboratory.
- Also see the following *Yersinia pestis* Biothreat Agent Bench Card for the Sentinel Clinical Laboratory for a summary of key characteristics (available on the web here:

<http://www.aphl.org/programs/preparedness/documents/aphl-sentinel-laboratory-biothreat-bench-cards.pdf>)

If you see the following characteristics:

- Plump, Gram negative rods (may be bipolar) from blood, lymph node aspirate, or respiratory specimens
- Colonies resemble enterics, but grow more slowly
- Growth better at 25-28°C than most other enterics
- May see “fried egg” or “hammered copper” (under magnification) colonies
- Slow-growing non-lactose fermenter on MAC/EMB
- Catalase (+), oxidase (-), urease (-), and indole (-)

Then you cannot rule out *Y. pestis*

Yersinia pestis IDENTIFICATION FLOWCHART

SAFETY: As soon as *Yersinia pestis* is suspected, perform ALL further work in a Class II BSC using BSL-3 practices.

Major characteristics of *Yersinia pestis*:

Gram stain morphology: Gram negative rods, 0.5 x 1-2 μm

Colony morphology: Slow growing at 35°C with either pinpoint colonies or no growth on BAP after 24h; colonies are 1-2 mm, gray-white to slightly yellow and opaque on BAP after 48 h; non-lactose fermenter on MAC/EMB

Specimen is blood, sputum, or lymph node aspirate

Yes

Oxidase: Negative
Catalase: Positive
Indole: Negative
Urease: Negative

No

Not *Yersinia pestis*.
Continue identification per routine laboratory procedures.
May be other *Yersinia* spp.

Yes

Y. pestis is not ruled out.

Contact LRN Reference Level Laboratory to refer the isolate.

Report: *Y. pestis* cannot be ruled out; isolate referred to LRN Reference Level Laboratory.

WARNING: Some of the automated identification systems do not identify *Y. pestis* adequately. *Y. pestis* has been falsely identified as *Y. pseudotuberculosis*, *Shigella*, H₂S negative *Salmonella*, *Acinetobacter*, and *Pseudomonas* species.

Refer the Patient Specimen or Isolate to your local LRN Reference Laboratory

If the organism cannot be ruled out then you must secure all of the plates, tubes, bottles, slides, and clinical specimens in case the isolate is confirmed as a select agent.

REPORTING AND NOTIFICATION TO STATE OR LOCAL PUBLIC HEALTH

If you see the following characteristics:

- Gram negative rods (may be bipolar) from blood, lymph node aspirate, or respiratory specimens
- Colonies resemble enterics, but grow more slowly
- Growth better at 25-28°C than most other enterics
- May see “fried egg” or “hammered copper” (under magnification) colonies
- Slow-growing non-lactose fermenter on MAC
- Catalase (+), oxidase (-), urease (-), and indole (-)

REPORT TO THE PATIENT’S PHYSICIAN AS “*Yersinia* species, UNABLE TO RULE-OUT *Y. pestis*”

Suspect cases should be immediately reported to the local health department for investigation. Prior to submitting specimens for testing, your LRN Reference Laboratory must be contacted for specimen submission guidance and to provide test notification. For confirmed cases, clinical laboratories must always refer to their State / Local and Federal disease notification and reporting requirements. See your state specific contact information in the State Section and the following link for Federal guidelines. <http://www.selectagents.gov/>

If *Y. pestis* cannot be ruled out then you must secure all of the plates, tubes, bottles, slides, and clinical specimens in case the isolate is confirmed as a select agent by your LRN Reference Lab.

SHIPPING AND TRANSFERS

- Upon notification to the local health department epidemiology program and coordination with your local Public Health LRN Reference Laboratory of a suspected *Yersinia pestis*, laboratories should be prepared to properly package and ship the sample(s).
 - Direct patient specimens (lymph node or tissue biopsy, sputum, CSF, etc.) may be shipped as Category B Biological Substances.
 - If a culture (including a positive blood culture bottle) is being submitted for LRN Rule-Out Testing, the shipment should be classified, handled, packaged and transported as “Suspected Category A.”
- Please note that an organism with a **confirmed** select agent identification will require a CDC/APHIS Form 2 if it is to be transferred rather than destroyed on-site within 7 calendar days. Plague is a Tier 1 Select Agent and not every LRN Reference Laboratory is registered to receive a confirmed Tier 1 agent, so consultation with the Select Agent program may be needed.

- If a culture is being submitted for LRN Rule-Out Testing, the shipment should be classified, handled, packaged and transported as “Suspected Category A.” See the *Packaging and Shipping* section contained within this guidance manual for additional information about sample classification and shipping procedures.

DESTRUCTION AND DECONTAMINATION

- The Public Health Agency of Canada has created Pathogen Safety Data Sheets for numerous human pathogens. These technical documents are intended to describe the hazardous properties of listed organisms and recommendations for work involving these agents in a laboratory setting. A complete list of the organisms as well as other safety related information is available here: <http://www.phac-aspc.gc.ca/lab-bio/res/psds-ftss/index-eng.php>.
- The Pathogen Safety Data Sheet for *Yersinia pestis* is available here: <http://www.phac-aspc.gc.ca/lab-bio/res/psds-ftss/msds169e-eng.php>
- If the identification is confirmed by your LRN Reference Lab then you must either transfer to a Tier 1 Select Agent-registered entity or destroy on-site all remaining materials, isolates, patient samples, etc. within 7 calendar days. Refer to the Biosafety, Biosecurity and Regulations section for directions on how to destroy, secure, or transfer the agent (See [DecontaminationSelectAgents JobAid 10 06 2015 Final Job Aid](#)). Work with your LRN Reference Laboratory on how to fill out the required paperwork.

EXPOSURES / MEDICAL/ CASE DEFINITION

- For the case definition of plague, please see <http://wwwn.cdc.gov/nndss/conditions/plague/case-definition/1996/>
- For current treatment recommendations, including post-exposure prophylaxis (PEP), please see <http://www.cdc.gov/plague/healthcare/clinicians.html>
- A vaccine for plague is not currently available in the U.S.
- Any potential exposure should be immediately reported to the local health department and will require the completion of CDC-APHIS Form 3. Refer to the Biosafety, Biosecurity, and Regulations Section for more information and guidance ([Form 3: APHIS/CDC Select Agent Job Aid](#)) or the Select Agent website (<http://www.selectagents.gov/form3.html>). You can also contact your LRN Reference Laboratory for assistance.

REFERENCES

- Abbott, R.C., and Rocke, T.E., 2012, Plague: U.S. Geological Survey Circular 1372, 79 p., plus appendix. (available at <http://pubs.usgs.gov/circ/1372>)
- APHL Biothreat Agent Bench Cards for the Sentinel Clinical Laboratory: <http://www.aphl.org/programs/preparedness/Documents/APHL-Sentinel-Laboratory-Biothreat-Bench-Cards.pdf>
- ASM (American Society for Microbiology) Sentinel Guidelines for Plague: <http://www.asm.org/images/PSAB/LRN/Ypestis316.pdf>

- CAP LPS & LPX Final Critiques, 2004-2014
- CDC Plague Website: <http://www.cdc.gov/plague/>
- CDC Healthcare Infection Control Practices Advisory Committee (HICPAC) 2007 Guideline for Isolation Precautions: Preventing Transmission of Infectious Agents in Healthcare Settings Table 3. Infection Control Considerations For High-Priority (Cdc Category A) Diseases That May Result From Bioterrorist Attacks Or Are Considered To Be Bioterrorist Threats: http://www.cdc.gov/hicpac/2007IP/2007ip_table3.html
- Heymann, David L. MD, ed., Control of Communicable Diseases Manual, 20th ed., 2015, APHA, pgs. 456-465
- MMWR Guidelines for Safe Work Practices in Human and Animal Medical Diagnostic Laboratories: <http://www.cdc.gov/mmwr/preview/mmwrhtml/su6101a1.htm>
- Nebraska Public Health Laboratory Bench Guide for Hazardous Pathogens, December 2013
- Public Health Agency of Canada Pathogen Safety Data Sheet for *Yersinia pestis*: <http://www.phac-aspc.gc.ca/lab-bio/res/psds-ftss/msds169e-eng.php>
- UPMC Center for Health Security *Yersinia pestis* (Plague) Fact Sheet: <http://www.upmchealthsecurity.org/our-work/publications/2013/plague-fact-sheet>



ALPHAVIRUSES

Eastern Equine Encephalitis (EEE) Virus, Venezuelan Equine Encephalitis (VEE) Virus, and Western Equine Encephalitis (WEE), Chikungunya (CHIKV)

DATE APPROVED:

8 / 1 / 2016

RECOMMENDATIONS FOR SAFE LABORATORY PRACTICES

These alphaviruses, especially VEE virus, are infectious by aerosol in laboratory studies and more than 160 EEE virus, VEE virus, or WEE virus laboratory-acquired infections have been documented. Many infections were due to procedures involving high virus concentrations and aerosol-generating activities such as centrifugation and mouth pipetting. Procedures involving animals (e.g., infection of newly hatched chicks with EEE virus and WEE virus) and mosquitoes also are particularly hazardous.

Due to the high risk of aerosol infection, additional personal protective equipment, including respiratory protection, should be considered for non-immune personnel. Vaccines are available only on a limited basis and may be contraindicated for some personnel. For personnel who have no neutralizing antibody titer (either by previous vaccination or natural infection), additional respiratory protection is recommended for all procedures.

Refer to the Biosafety, Biosecurity and Regulations section contained within this guidance manual, the Biosafety in Microbiological and Biomedical Laboratories (BMBL) (<http://www.cdc.gov/biosafety/publications/bmb15/>) and Guidelines for Safe Work Practices in Human and Animal Medical Diagnostic Laboratories (<http://www.cdc.gov/mmwr/preview/mmwrhtml/su6101a1.htm>) for more information.

SAFETY CONSIDERATIONS:

Diagnostic and research activities involving clinical material, infectious cultures, and infected animals or arthropods should be performed under BSL-3 practices, containment equipment, and facilities.

DISEASE TRANSMISSION AND CLINICAL PRESENTATION

Eastern Equine Encephalitis (EEE), Western Equine Encephalitis (WEE), Venezuelan Equine Encephalitis (VEE), and Chikungunya viruses (CHIKV) belong to the genus Alphaviruses within the family Togaviridae. These zoonotic viruses are maintained in natural transmission cycles of various mosquitoes and avian or small rodent hosts. Humans and horses are accidental hosts that become infected upon the bite of an infected mosquito.

EEE virus occurs in focal locations along the eastern seaboard, the Gulf Coast and some inland Midwestern locations of the United States, in Canada, some Caribbean Islands, and Central and South America. The WEE virus is found mainly in western parts of the United States and Canada although sporadic infections also occur in Central and South America. People infected with Eastern equine encephalitis virus (EEE) can develop systemic (abrupt onset and is characterized by chills, fever, malaise, arthralgia, and myalgia) or encephalitic (fever, headache, irritability, restlessness, drowsiness,

anorexia, vomiting, diarrhea, cyanosis, convulsions, and coma) disease 4 to 10 days from being bitten by an infected mosquito. The type of illness will depend on the age of the person and other host factors. It is possible that some people who become infected with EEE may be asymptomatic.

Currently, local Chikungunya transmission has been identified in 44 countries or territories throughout the Americas. Most people infected with Chikungunya virus (CHIKV) will develop acute fever and polyarthralgia usually beginning 3–7 days after being bitten by an infected mosquito. Although the most common clinical presentations of symptoms are acute onset of fever and polyarthralgia, specifically of the wrists and knees, however other symptoms may include headache, muscle pain, joint swelling particularly of the hands and feet, or maculopapular rash. Chikungunya disease does not often result in death, but the symptoms can be severe and lead to chronic joint pain that in rare cases can be debilitating and lasts for months or years. Many patients will experience relapse of rheumatologic symptoms months after acute illness recovery. Common laboratory findings to help in diagnosis for CHIKV patients are lymphopenia, thrombocytopenia and elevated creatinine levels.

Focal VEE virus outbreaks occur periodically in Central and South America, with rare large regional epizootics involving thousands of equine cases and deaths in predominantly rural settings. Epizootic and enzootic strains of the VEE virus range from northern Argentina to Florida and parts of the Rocky Mountains; however, it is most prevalent in northern South America. VEE usually causes mild to severe influenza-like symptoms such as headache, myalgia, fatigue, vomiting, nausea, diarrhea, pharyngitis and fever appear abruptly, 2 to 5 days after exposure to the virus 4-14% of cases develop neurological complications such as somnolence, convulsions, confusion, photophobia, and coma that develop within 4- 10 days after exposure. Long-term neurological damage can be caused by this virus and it can infect the fetus in pregnant women causing birth defects and stillbirths.

Infectious dose for the alphaviruses remains unknown except for VEE. Studies have shown that only 1 virus particle is needed for VEE infection.

Please refer to the following links for additional information:

<http://www.cdc.gov/EasternEquineEncephalitis/tech/factSheet.html>

<http://www.cdc.gov/chikungunya/>

LABORATORY TESTING INFORMATION

Laboratory diagnosis of arboviral infections is generally accomplished by testing of serum or cerebrospinal fluid (CSF) to detect virus-specific IgM and neutralizing antibodies. Testing for IgM should only be performed if symptoms onset was within 7 days of collection. If testing is requested after the patients initial acute phase (within 7 days of onset), convalescent serum testing can be performed by testing for both IgG and IgM to better confirm the patients results and time of exposure. For some alphaviruses like CHIKV, if a patient is still in acute phase PCR testing should be performed. PCR testing is now available for CHIKV through many commercial and public health laboratories and provides much more sensitive and specific result that can lead to a confirmed a patients diagnosis.

In fatal cases, nucleic acid amplification, histopathology with immunohistochemistry and virus culture of autopsy tissues can also be useful. Some state public health laboratories or other specialized laboratories, including those at CDC, are capable of doing this specialized testing. Contact your local epidemiology department or your state public health department for specific testing and collection guidance.

*Confirmed EEE virus and VEE virus and genomic material are select agents requiring additional actions to comply with the Federal Select Agent regulations.

REPORTING AND NOTIFICATION TO STATE OR LOCAL PUBLIC HEALTH

Suspect cases should be immediately reported to the local health department for investigation. Prior to submitting specimens for testing, your public health laboratory must be contacted for specimen submission guidance and to provide test notification. For confirmed cases, clinical laboratories must always refer to their State or Local disease notification and reporting requirements. See your state specific contact information in the State Section.

SHIPPING AND TRANSFERS

Upon notification to the local health department and the state Public Health Laboratory of a suspected alphavirus infection, laboratories should be prepared to properly package and ship the sample(s). See the *Packaging and Shipping* Section contained within this guidance manual for additional information about sample classification and shipping procedures.

Please note that if an organism is confirmed as a select agent (EEE and VEE), CDC/APHIS Form 2 must be submitted to the Division of Select Agent and Toxins (DSAT) if the samples are to be transferred rather than destroyed on-site within 7 calendar days.

DESTRUCTION AND DECONTAMINATION

The Public Health Agency of Canada has created Pathogen Safety Data Sheets for numerous human pathogens. These technical documents are intended to describe the hazardous properties of listed organisms and recommendations for work involving these agents in a laboratory setting. A complete list of the organisms as well as other safety related information is available here:

<http://www.phac-aspc.gc.ca/lab-bio/res/psds-ftss/index-eng.php>.

The Pathogen Safety Data Sheets for EEE, VEE, and Chikungunya viruses are available here:

EEE: <http://www.phac-aspc.gc.ca/lab-bio/res/psds-ftss/equine-eng.php>

VEE: <http://www.phac-aspc.gc.ca/lab-bio/res/psds-ftss/ven-encephalit-eng.php>

Chikungunya: <http://www.phac-aspc.gc.ca/lab-bio/res/psds-ftss/chikungunya-eng.php>

If the EEE or VEE identification is confirmed then you must either transfer or destroy all remaining materials, isolates, patient samples, etc. within 7 days. Refer to the Biosafety, Biosecurity and

Regulations section for directions on how to destroy, secure, or transfer the agent (See [DecontaminationSelectAgents JobAid 10 06 2015 Final Job Aid](#)) . Work with your LRN Reference Laboratory on how to fill out the required paperwork.

EXPOSURES / MEDICAL/ CASE DEFINITION

No specific antiviral treatment for alphaviral infections is available. Patients with suspected infections should be hospitalized, appropriate serologic and other diagnostic tests ordered, and supportive treatment provided.

Please see following links for case definitions:

<http://www.cdc.gov/nndss/conditions/arboviral-encephalitis/case-definition/1996/>

http://www.searo.who.int/entity/emerging_diseases/topics/Def_Chikungunya_Fever.pdf

For EEE and VEE, any potential exposures should be immediately reported to the local health department and will require the completion of CDC-APHIS Form 3. Refer to the Biosafety, Biosecurity, and Regulations Section for more information and guidance ([Form 3: APHIS/CDC Select Agent Job Aid](#)) or the Select Agent website (<http://www.selectagents.gov/form3.html>). You can also contact your LRN Reference Laboratory for assistance.

REFERENCES

<http://www.cdc.gov/biosafety/publications/bmbI5/>

<http://www.cdc.gov/EasternEquineEncephalitis/tech/factSheet.html>

<http://www.cdc.gov/chikungunya/>

<http://www.phac-aspc.gc.ca/lab-bio/res/psds-ftss/equine-eng.php>

<http://www.phac-aspc.gc.ca/lab-bio/res/psds-ftss/ven-encephalit-eng.php>

<http://www.phac-aspc.gc.ca/lab-bio/res/psds-ftss/chikungunya-eng.php>

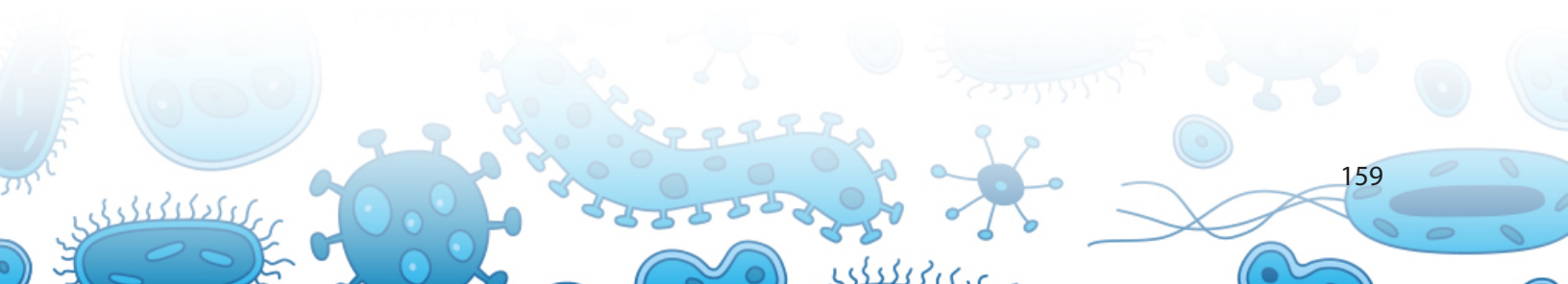

BOTULINUM TOXIN (BoNT) *CLOSTRIDIUM BOTULINUM*

RECOMMENDATIONS FOR SAFE LABORATORY PRACTICES

Botulism neurotoxins and Botulism neurotoxin-producing species of *Clostridium* are designated as Tier 1 agents according to Federal Select Agents and Toxins Regulations. Federal regulations can be viewed at <http://www.selectagents.gov/>. If Botulism toxin poisoning is suspected, do not attempt to culture, identify the organism, or perform toxin assays. Botulism is a medical emergency even when criminal activity is not suspected. Diagnosis is made by clinical findings and confirmed by toxin detection. Toxin detection is available at selected public health laboratories.

Refer to the Biosafety, Biosecurity and Regulations section contained within this guidance manual, the Biosafety in Microbiological and Biomedical Laboratories (BMBL) (<http://www.cdc.gov/biosafety/publications/bmb15/>) and Guidelines for Safe Work Practices in Human and Animal Medical Diagnostic Laboratories (<http://www.cdc.gov/mmwr/preview/mmwrhtml/su6101a1.htm>) for more information.

DATE APPROVED:

8 / 1 / 2016

SAFETY CONSIDERATIONS:

Clostridium toxin is a very potent neurotoxin. Manipulation of specimen material should be avoided and only manipulated using Biosafety Level 3 practices.

DISEASE TRANSMISSION AND CLINICAL PRESENTATION

Clostridium botulinum is a global soil and water-dwelling bacterium that produces spores when conditions are unfavorable. Upon introduction into the body through consumption, a breach in skin, or inhalation, the organism grows and produces debilitating neurotoxins that cause a variety of symptoms leading to acute flaccid paralysis. See the following links for more specific information:

- <http://emergency.cdc.gov/agent/botulism/>
- <http://emergency.cdc.gov/agent/botulism/factsheet.asp>

DIFFERENTIAL DIAGNOSIS

Differential Diagnosis for Adults: Guillain-Barre syndrome, myasthenia gravis, cerebrovascular accident (CVA), bacterial and/or chemical food poisoning, tick paralysis, chemical intoxication (e.g., carbon monoxide), mushroom poisoning, poliomyelitis, psychiatric illness

Differential Diagnosis for Infants: sepsis, meningitis, electrolyte-mineral imbalance, Reye's syndrome, congenital myopathy, Werdnig-Hoffman disease, Leigh disease

LABORATORY TESTING INFORMATION

Initial diagnosis is based on clinical findings, and treatment should not wait for laboratory confirmation. *Clostridium* toxin confirmation is made by demonstrating the presence of toxin in

serum, stool, or food, or by culturing *C. botulinum* from stool, wound, or food. Toxin detection and organism culture is available at selected public health laboratories. For additional information, see the ASM Botulinum Toxin guidelines at: <http://www.asm.org/index.php/science-skills-in-the-lab/sentinel-guidelines>

REPORTING AND NOTIFICATION TO STATE OR LOCAL PUBLIC HEALTH

Suspect cases should be immediately reported to the local health department for investigation. Prior to submitting specimens for testing, your public health laboratory must be contacted for specimen submission guidance and to provide test notification. For confirmed cases, clinical laboratories must always refer to their State or Local disease notification and reporting requirements. See your state specific contact information in the State Section.

ACCEPTABLE SAMPLE TYPES

Isolates – Isolates inoculated onto anaerobic media (such as isolates recovered from wound cultures).

Serum – Collect 10 mL of serum.

Enema Fluid – Collect 20 mL of fluid. Purge with a minimum of sterile, non-bacteriostatic water to minimize dilution of toxin.

Gastric or Vomitus - Collect 20 mL of stool in sterile, leakproof container.

Tissue, Exudate, or wound swab – Specimens should be placed in anaerobic transport media and transported at room temperature.

Autopsy specimens - Feces, gastric contents and serum if available. Collect feces from different levels of both large and small intestine. Transport all specimens as described above.

Feces - Collect 10-50 g of stool in sterile, leakproof container.

Food sample – Collect 10-50 g. Submit food in original container. Place each container into leakproof, sealed transport device.

*For aerosolized release, collect nasal swabs for *C. botulinum* and serum for toxin testing.

SHIPPING AND TRANSFERS

Upon notification to the local health department epidemiology program and coordination with your local Public Health LRN Reference Laboratory of a suspected Botulinum toxin, laboratories should be prepared to properly package and ship the sample(s). All samples other than anaerobic cultures should be transported at 4-8°C. Anaerobic cultures should be submitted in anaerobic media at room temperature. If an anaerobic culture is being submitted for LRN Rule-Out Testing, the shipment should be classified, handled, packaged, and transported as “Suspected Category A.” Please note that an organism with a confirmed select agent identification will require a CDC/APHIS Form 2 for transfer.

See the *Packaging and Shipping* Section contained within this guidance manual for additional information about sample classification and shipping procedures.

DESTRUCTION AND DECONTAMINATION

The Public Health Agency of Canada has created Pathogen Safety Data Sheets for numerous human pathogens. These technical documents are intended to describe the hazardous properties of listed organisms and recommendations for work involving these agents in a laboratory setting. A complete list of the organisms as well as other safety related information is available here:

<http://www.phac-aspc.gc.ca/lab-bio/res/psds-ftss/index-eng.php>.

Contact with freshly prepared solutions of 1:10 household bleach* (sodium hypochlorite >0.1%) or sodium hydroxide (NaOH > 0.25 N) for 30 minutes inactivate BoNT and are recommended for decontaminating work surfaces and spills of *C. botulinum* or BoNT.

If the identification is confirmed then you must either transfer or destroy all remaining materials, isolates, patient samples, etc. within 7 days. Refer to the Biosafety, Biosecurity and Regulations section for directions on how to destroy, secure, or transfer the agent (See [DecontaminationSelectAgents JobAid 10 06 2015 Final Job Aid](#)). Work with your LRN Reference Laboratory on how to fill out the required paperwork.

EXPOSURES / MEDICAL/ CASE DEFINITION

An equine antitoxin product is available for treatment of patients with symptoms consistent with botulism. However, due to the risks inherent in equine products, treatment is not provided as a result of exposure unless botulism symptoms are present.

For current treatment recommendations, please see <http://emergency.cdc.gov/agent/Botulism/clinicians/treatment.asp>

For case definition of *Clostridium botulinum* please see <http://wwwn.cdc.gov/nndss/conditions/botulism/>

Any potential exposures should be immediately reported to the local health department and will require completion of CDC-APHIS Form 3. Refer to the Biosafety, Biosecurity and Regulations Section for more information and guidance or the Select Agent website (<http://www.selectagents.gov/form3.html>). You can also contact your LRN Reference Laboratory for assistance.

REFERENCES

<http://emergency.cdc.gov/agent/botulism/>
<http://www.phac-aspc.gc.ca/lab-bio/res/psds-ftss/index-eng.php>
<http://www.cdc.gov/mmwr/preview/mmwrhtml/mm5041a2.htm>
<http://www.asm.org/index.php/science-skills-in-the-lab/sentinel-guidelines>

<http://www.cdc.gov/biosafety/publications/bmb15/>
<http://www.selectagents.gov/>

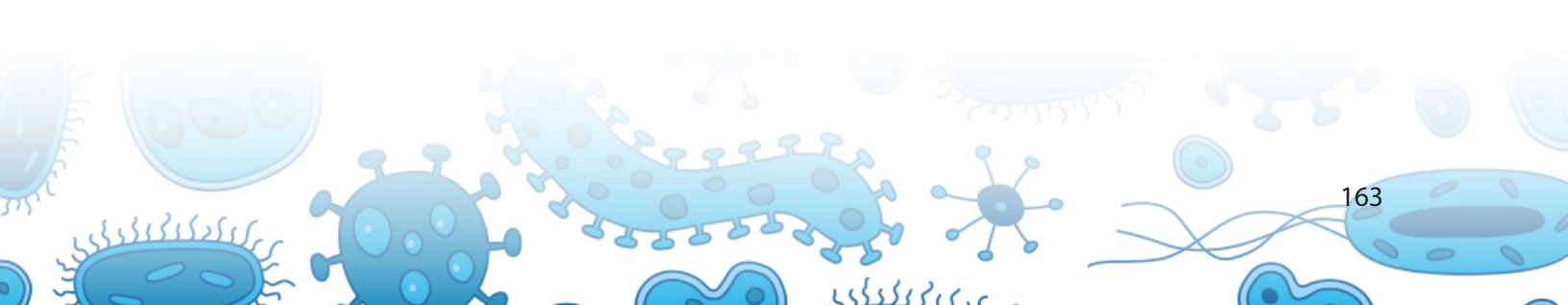

Coxiella burnetii (Q FEVER)



DATE APPROVED:

8 / 1 / 2016

APHL/EID Fellow Amanda Candee collecting environmental samples from a sheep pen in western Colorado. Sheep are a major reservoir for *Coxiella burnetii*.

RECOMMENDATIONS FOR SAFE LABORATORY PRACTICES

Because of the highly infectious nature of this organism (Biosafety Level 3 [BSL-3]), specimens from suspected cases of Q fever should be immediately forwarded to a Local or State Health Department identified as your Laboratory Response Network (LRN) Reference Laboratory. Sentinel Laboratories should not attempt to culture this organism, but should be aware of the potential for inadvertent isolation of *C. burnetii* in cell culture systems designed for virus isolation.

Biohazardous waste should be decontaminated by autoclaving. Contaminated equipment or instruments can be decontaminated with approved disinfectants. Special decontamination procedures are necessary for surfaces potentially contaminated with *C. burnetii*. Household bleach solutions may be ineffective. Minor spills should be covered with absorbent paper, such as paper towels, and then flooded with 70-95% alcohol or 5% MicroChem-Plus (a dual quaternary ammonium compound), which should be allowed to act for 30 min before cleanup. Spills that involve samples with high concentrations of organisms, involve organic matter, or occur in areas of lower temperatures (e.g., refrigerators or freezers), should be exposed to disinfectant solution for 1 h before cleanup. See the American Society for Microbiology (ASM) Guidelines to *C. burnetii*: <http://www.asm.org/index.php/science-skills-in-the-lab/sentinel-guidelines>.

Refer to the Biosafety, Biosecurity and Regulations section contained within this guidance manual, the Biosafety in Microbiological and Biomedical Laboratories (BMBL) (<http://www.cdc.gov/biosafety/publications/bmb15/>) and Guidelines for Safe Work Practices in Human and Animal Medical Diagnostic Laboratories (<http://www.cdc.gov/mmwr/preview/mmwrhtml/su6101a1.htm>) for more information.

SAFETY CONSIDERATIONS:

As soon as *Coxiella burnetii* is suspected in the laboratory, perform ALL further work within in containment such as within a Class II Biological Safety Cabinet (BSC) and observe and follow BSL-3 practices when possible.

DO NOT ATTEMPT TO CULTURE THIS ORGANISM.

DISEASE TRANSMISSION AND CLINICAL PRESENTATION

Q fever is a zoonotic disease caused by *Coxiella burnetii*, a species of bacteria that is distributed globally.

Cattle, sheep, and goats are the primary reservoirs of *C. burnetii*. *C. burnetii* is an intracellular bacterium that must be grown in cell culture.

Annual reported incidence (per million population) for Q Fever in the United States for 2008

(http://www.cdc.gov/qfever/images/statsEpi/QFever_incid.jpg)

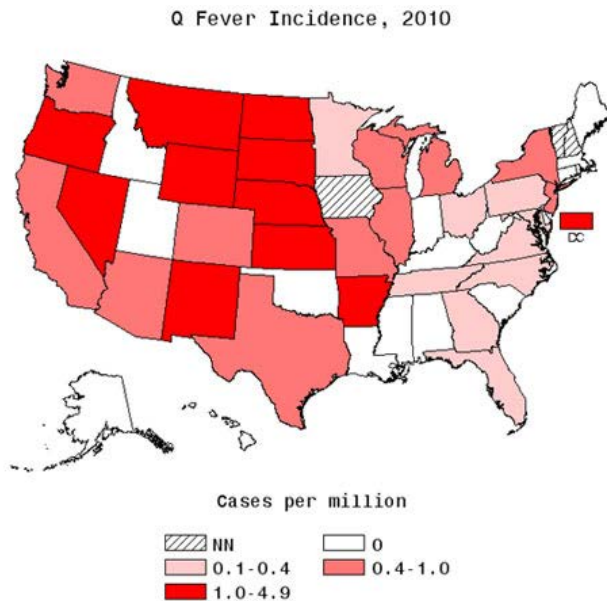

Modes of transmission to humans include tick bites and ingestion of unpasteurized milk or dairy products. Human to human transmission is rare. Humans are often very susceptible to the disease, and very few organisms may be required to cause infection.

ACCEPTABLE SAMPLE TYPES

DO NOT ATTEMPT TO CULTURE THIS ORGANISM but be aware of the potential for inadvertent isolation of *C. burnetii* in cell culture systems designed for virus isolation.

(<http://www.asm.org/index.php/science-skills-in-the-lab/sentinel-guidelines>)

Collection of Clinical Specimens for Transport to Reference Laboratory	
Whole blood	<ul style="list-style-type: none"> • Collect blood in EDTA (lavender) or sodium citrate (blue) top tube. • Maintain at 4°C for storage and shipping for PCR or special cultures. • Collect specimens prior to antimicrobial therapy, if possible.

Collection of Clinical Specimens for Transport to Reference Laboratory	
Tissue, body fluids, and others, including cell cultures and cell supernatants.	<ul style="list-style-type: none"> • Maintain at 2 to 8°C and transport within 24 h. • Store biopsies for PCR or immunohistochemical staining frozen at minus 70° C or on dry ice.
Serum	<ul style="list-style-type: none"> • Acute phase: Collect serum (red-top or serum separator tube [SST], tiger-top tube) as soon as possible after onset of symptoms. • Convalescent phase: Collect a follow-up specimen at ≥14 days. • Separate and store serum frozen until testing.

WARNING: Using automated systems, including Mass Spectrometry (MALDI-TOF) technology may result in exposure to dangerous pathogens, and could result in erroneous identification, e.g., *Bacillus anthracis* misidentified as *B. cereus*; *Yersinia pestis* misidentified as *Y. pseudotuberculosis*.

MALDI-TOF IDENTIFICATION

If your laboratory uses mass spectrometry (MALDI-TOF) for bacterial identification, and if the manufacturer provides your facility with an alternate tube extraction method, it is recommended that the resulting extract be filtered using a 0.2 µm (or less) filter. This additional step is recommended to reduce the chance of laboratory contamination with viable bacteria and spores.

Because of the highly infectious nature of *C. burnetii* it is still recommended that samples be sent to your LRN Reference Laboratory for testing.

LABORATORY TESTING INFORMATION

Refer to the ASM Sentinel Level Clinical Laboratory Protocols for more detailed information: <http://www.asm.org/index.php/science-skills-in-the-lab/sentinel-guidelines>. For additional testing information, please contact your local LRN Reference Laboratory.

REPORTING AND NOTIFICATION TO STATE OR LOCAL PUBLIC HEALTH

Suspect cases should be immediately reported to the local health department for investigation. Prior to submitting specimens for testing, your LRN Reference Laboratory must be contacted for specimen submission guidance and to provide test notification. For confirmed cases, clinical laboratories must always refer to their State / Local and Federal disease notification and reporting requirements. See your state specific contact information in the State Section and the following link for Federal guidelines. <http://www.selectagents.gov/>

REPORTING AND INTERPRETATION OF RESULTS

Whole blood and swabs are tested by Real-time PCR for the presence of *C. burnetii* DNA. Positive samples of *C. burnetii* will be reported and may be forwarded to the Centers for Disease Control and Prevention in Atlanta, Georgia for confirmation of laboratory results.

SHIPPING AND TRANSFERS

Upon notification to the local health department epidemiology program and coordination with your local Public Health LRN Reference Laboratory of a suspected *C. burnetii* sample, laboratories should be prepared to properly package and ship the sample(s). If a culture is being submitted for LRN Rule-Out Testing, the shipment should be classified, handled, packaged and transported as “Suspected Category A.” Please note that an organism with a confirmed select agent identification will require a CDC/APHIS Form 2 for transfer. See the *Packaging and Shipping* Section contained within this guidance manual for additional information about sample classification and shipping procedures.

SHIPMENT OF SPECIMENS

Specimens should be collected as soon as possible and refrigerated if delays are unavoidable. All specimens should be kept at refrigerated temperatures during shipment.

DESTRUCTION AND DECONTAMINATION

The Public Health Agency of Canada has created Pathogen Safety Data Sheets for numerous human pathogens. These technical documents are intended to describe the hazardous properties of listed organisms and recommendations for work involving these agents in a laboratory setting. A complete list of the organisms as well as other safety related information is available here:

<http://www.phac-aspc.gc.ca/lab-bio/res/psds-ftss/index-eng.php>.

If the identification is confirmed then you must either transfer or destroy all remaining materials, isolates, patient samples, etc. within 7 days. Refer to the Biosafety, Biosecurity and Regulations section for directions on how to destroy, secure, or transfer the agent (See [DecontaminationSelectAgents JobAid 10 06 2015 Final Job Aid](#)). Work with your LRN Reference Laboratory on how to fill out the required paperwork.

EXPOSURES / MEDICAL/ CASE DEFINITION

There is no role for prophylactic antimicrobial agents in preventing Q fever after a known exposure and prior to symptom onset; attempts at prophylaxis will likely extend the incubation period by several days but will not prevent infection from occurring.

Doxycycline is the first line treatment for all adults, and for children with severe illness. Treatment should be initiated immediately whenever Q fever is suspected.

For current treatment recommendations, please see <http://www.cdc.gov/qfever/symptoms/index.html>.

For case definition of Q Fever, please see: <http://wwwn.cdc.gov/nndss/conditions/q-fever/case-definition/2009/>.

Any potential exposures should be immediately reported to the local health department and will require completion of CDC-APHIS Form 3. Refer to the Biosafety, Biosecurity and Regulations Section for more information and guidance or the Select Agent website (<http://www.selectagents.gov/form3.html>). You can also contact your LRN Reference Laboratory for assistance.

REFERENCES

<http://www.asm.org/images/PSAB/LRN/Coxiella316.pdf>

<http://www.phac-aspc.gc.ca/lab-bio/res/psds-ftss/coxiella-burnetii-eng.php>

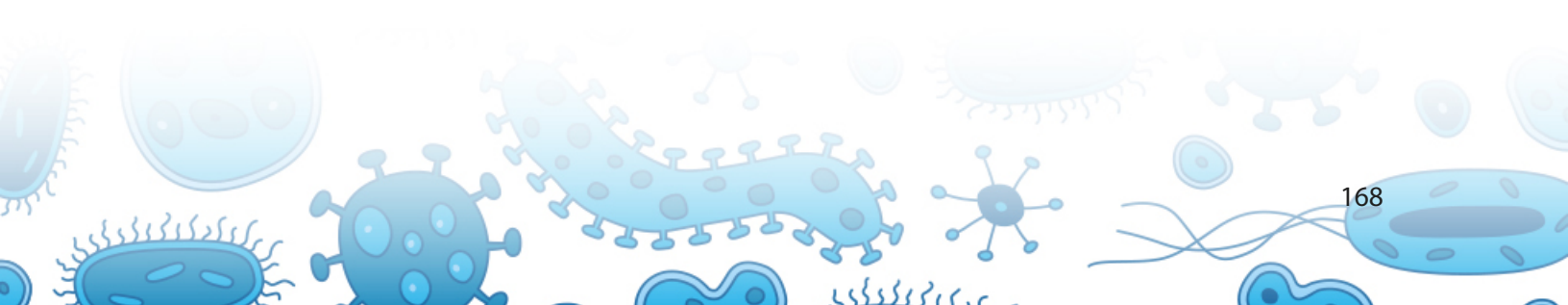

ORTHOPOX VIRUSES (SMALLPOX)

RECOMMENDATIONS FOR SAFE LABORATORY PRACTICES

Caution should be used when collecting clinical specimens thought to contain Smallpox. All processes including collection, processing, and packaging and shipping should be performed in a **BSL-3 laboratory or using BSL-3 practices in a BSL-2 environment.**

The individual collecting the sample should wear the appropriate personal protective equipment including gloves, disposable gown, shoe covers, mask and eyewear or face shield. Respiratory protection is not necessary, but is recommended for individuals without a recent vaccination.

The Public Health Agency of Canada has created Pathogen Safety Data Sheets for numerous human pathogens. These technical documents are intended to describe the hazardous properties of listed organisms and recommendations for work involving these agents in a laboratory setting. A complete list of the organisms as well as other safety related information is available here: <http://www.phac-aspc.gc.ca/lab-bio/res/psds-ftss/index-eng.php>.

Refer to the Biosafety, Biosecurity and Regulations section contained within this guidance manual, the Biosafety in Microbiological and Biomedical Laboratories (BMBL) (<http://www.cdc.gov/biosafety/publications/bmb15/>) and Guidelines for Safe Work Practices in Human and Animal Medical Diagnostic Laboratories (<http://www.cdc.gov/mmwr/preview/mmwrhtml/su6101a1.htm>) for more information.

LABORATORY TESTING INFORMATION

Refer to the ASM Sentinel Level Clinical Laboratory Protocols for more detailed information: <http://www.asm.org/index.php/science-skills-in-the-lab/sentinel-guidelines>. For additional testing information, please contact your local LRN Reference Laboratory.

SAMPLE COLLECTION

If testing is to be conducted at the State Public Health Laboratory, the following samples may be submitted for testing:

DATE APPROVED:

8 / 1 / 2016

SAFETY CONSIDERATIONS:

As soon as any Orthopoxvirus is suspected in the laboratory, perform ALL further work within in containment such as within a Class II Biological Safety Cabinet (BSC) and observe and follow BSL-3 practices when possible.

If Smallpox is suspected, a mandatory CDC Risk Assessment algorithm must be completed prior to sample collection and shipment.

- Vesicular fluid (be sure to collect some cells from the base of the lesion with fluid), skin or crust from the roof of a vesicle,
- Nylon swab of a lesion, or
- Fresh tissue biopsy (Submit swabs, biopsy tissue and scabs dry, **DO NOT** add viral transport medium, a dry swab is preferred.).

Orthopoxviruses are one of eight genera that comprise the Poxviridae family of viruses and includes viruses such as variola virus (Smallpox), vaccinia virus (Smallpox vaccine), and monkeypox.

CDC Smallpox Laboratory Testing:

<http://emergency.cdc.gov/agent/smallpox/lab-testing/>

REPORTING

Specimens submitted for Smallpox testing will be tested for the presence of orthopoxvirus and non-variola orthopoxvirus DNA by PCR. Testing conducted at the State Public Health Laboratory detects the presence of orthopoxvirus DNA but does not exclusively detect the presence of Smallpox DNA. All results will be reported (via phone call) to the submitting agencies and the appropriate State Epidemiology and Disease Control units. Positive results will be reported to Centers for Disease Control and Prevention. Positive sample material may be forwarded to the Centers for Disease Control and Prevention in Atlanta, Georgia for additional laboratory testing.

REPORTING AND NOTIFICATION TO STATE OR LOCAL PUBLIC HEALTH

Suspect cases should be immediately reported to the local health department for investigation. Prior to submitting specimens for testing, your LRN Reference Laboratory must be contacted for specimen submission guidance and to provide test notification. For confirmed cases, clinical laboratories must always refer to their State / Local and Federal disease notification and reporting requirements. See your state specific contact information in the State Section and the following link for Federal guidelines. <http://www.selectagents.gov/>

SHIPPING AND TRANSFERS

Upon completion of the risk assessment it is decided that the sample meets the CDC criteria for Smallpox testing, notification must be made to the local health department epidemiology program in coordination with your local Public Health LRN Reference Laboratory. The local LRN Reference Laboratory will either accept and test the sample or forward the specimen to a laboratory with the appropriate safety level facilities for testing.



Package specimens from each individual being tested separately. **Do not** package samples from multiple patients in one bag. Samples should be shipped within 24 hours of collection and be held at 2-8°C. If samples will not be received in the lab within 24 hours, samples should be stored and shipped on dry ice or at -20°C to -70°C. All packages must meet the current IATA and DOT standards for shipping infectious substances. Please note that an organism with a confirmed select agent identification will require a CDC/APHIS Form 2 for transfer. See the *Packaging and Shipping* Section contained within this guidance manual for additional information about sample classification and shipping procedures.

SMALLPOX VARIOLA VIRUS (ORTHOPOX)

Transmission: Droplet (within 6 feet)

Incubation: 10 to 14 days – Infectious until all scabs separate!

Symptoms: Fever: 3 to 4 days

Rash: Lesions evolve distally (pharynx, face, feet)

Day 1-2 Macules – minute red spots on tongue > palate > face > forehead

Day 2 Papules – red spots slightly raised; virus present

Day 4-5 Vesicles – accumulation of fluid

Day 7 Pustules – fluid becomes pus

Day 8-21 Scabs – absorbed lesions become flat and dried

Smallpox:

Pox all in same stage

Slow development

More pox on arms and legs

Present on palms and soles

Chicken Pox:

Pox in several stages

Rapid development

More pox on trunk of body

Usually absent on palms and soles

Vesicular/Pustular Testing Methods:

Shell vial & DFA – Differentiates VZV and Vaccinia

Monoclonal IFA – Differentiates HSV and Enteroviruses

Molecular tests – PCR and sequencing for *Variola*

Electron microscopy - *Variola*

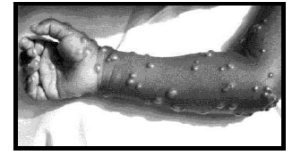
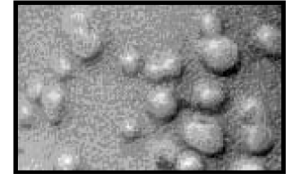

DESTRUCTION AND DECONTAMINATION

If the identification is confirmed then you must either transfer or destroy all remaining materials, isolates, patient samples, etc. within 7 days. Refer to the Biosafety, Biosecurity and Regulations section for directions on how to destroy, secure, or transfer the agent (See [DecontaminationSelectAgents JobAid 10 06 2015 Final Job Aid](#)). Work with your LRN Reference Laboratory on how to fill out the required paperwork.

EXPOSURES / MEDICAL/ CASE DEFINITION

Any potential exposures should be immediately reported to the local health department and will require the completion of CDC-APHIS Form 3. Refer to the Biosafety, Biosecurity, and Regulations Section for more information and guidance ([Form 3: APHIS/CDC Select Agent Job Aid](#)) or the Select Agent website (<http://www.selectagents.gov/form3.html>). You can also contact your LRN Reference Laboratory for assistance.

REFERENCES

CDC Smallpox

<http://emergency.cdc.gov/agent/smallpox/lab-testing/>

Biosafety in Microbiological and Biomedical Laboratories

<http://www.cdc.gov/biosafety/publications/bmb15/>

ASM Guidelines

<http://www.asm.org/index.php/science-skills-in-the-lab/sentinel-guidelines>

Select Agent Program

<http://www.selectagents.gov/>

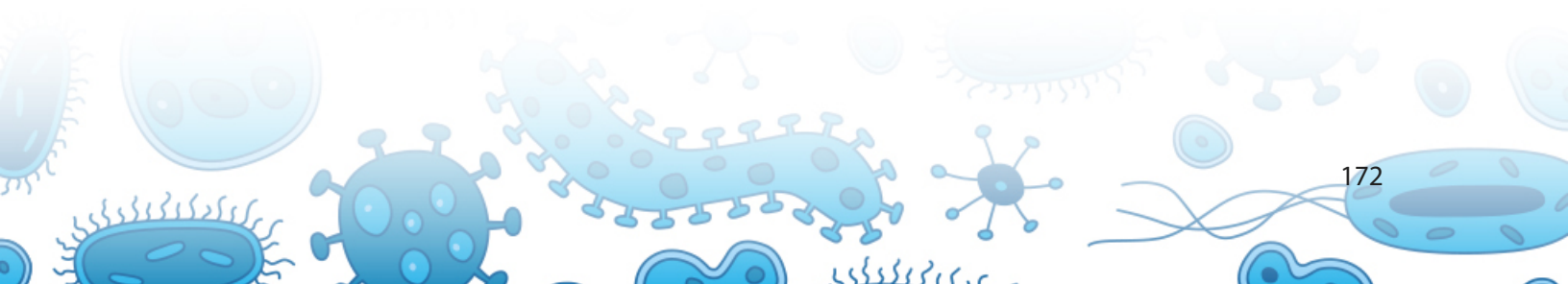

RICINUS COMMUNIS (RICININE)

DISEASE TRANSMISSION AND CLINICAL PRESENTATION

Ricin is a bio toxin that is purified from the hull of the castor bean and is one of the most toxic biologic agents known. Ricin is a toxalbumin, a biological toxin whose mechanism of action is inhibition of protein synthesis (manufacture of proteins) in eukaryotic cells; cell death results from the absence of proteins.

The effects of ricin poisoning depend upon the amount of ricin exposure, the route of exposure and the person's premorbid condition.

Ingestion and mastication of three to eight castor beans is the estimated fatal dose in adults. The fatal dose in children is not known, but likely is less.

Ricin is not as well absorbed into the body via ingestion when compared to injection or inhalation. Inhalation or injection of ricin would be expected to lead to a more rapid onset of signs and symptoms of ricin poisoning and a more rapid progression of poisoning compared to ingestion, given the same exposure amount.

CDC Facts about Ricin: <http://emergency.cdc.gov/agent/ricin/facts.asp>

RICIN TOXIN

Source:

Plan: *Ricinus communis*, Castor beans

Pathogenesis:

B-chain binds to carbohydrate receptors on the cell wall and allows toxin complex to enter the cell

A-chain inactivates ribosomes and halts protein synthesis

Symptoms:

6-18 hrs post exposure

Fever, cough, chest tightness, dyspnea, cyanosis,

Gastroenteritis and necrosis; death in ~72 hrs

Toxicity: (route dependent):

DATE APPROVED:

8 / 1 / 2016

SAFETY CONSIDERATIONS:

Ricin is a highly toxic poison found naturally in castor beans, which are seeds from the plant *Ricinus communis*. Ricin is poisonous if ingested, inhaled or injected. There is no antidote or specific medical treatment available. Patients receive supportive care to minimize the effects of the poison.



Low oral toxicity due to poor absorption and enzymatic digestion in the GI tract
Low dermal toxicity unless mixed with a strong solvent
High inhalation toxicity resulting in severe necrosis and pneumonia
High injection toxicity resulting in necrosis

LABORATORY TESTING INFORMATION

Ricin samples may be tested at your LRN Reference Laboratory in one of two ways, either as an **environmental sample** of the ricin protein itself or from the ricinine marker for ricin from **patient urine samples** of someone suspected of having been exposed to ricin.

ENVIRONMENTAL SAMPLES

Ricin environmental samples are a **Hazardous Material** and should be handled only by a Hazmat specialist. Contact your local Police Department for further assistance.

PATIENT SAMPLES

To check for chemical exposure to ricin, patient samples are tested by the State Public Health Laboratory Chemical Emergency Response Section or LRN-C laboratory if they are capable of testing for ricinine, a marker for ricin. If they are not capable of testing, they will forward the samples to CDC or to a LRN-C laboratory that is able to test for it.

REPORTING AND NOTIFICATION TO STATE OR LOCAL PUBLIC HEALTH

Suspect cases should be immediately reported to the local health department for investigation. Prior to submitting specimens for testing, your public health laboratory must be contacted for specimen submission guidance and to provide test notification. For confirmed cases, clinical laboratories must always refer to their State or Local disease notification and reporting requirements. See your state specific contact information in the State Section and the following link for Federal guidelines.
<http://www.selectagents.gov/>

SHIPPING AND TRANSFERS

Upon notification to the local health department epidemiology program and coordination with your local Public Health LRN Reference Laboratory of a suspected case of Ricin poisoning, laboratories should be prepared to properly package and ship the sample(s). See the *Packaging and Shipping* Section contained within this guidance manual for additional information about sample classification and shipping procedures.

Please note that a confirmed select agent will require a CDC/APHIS Form 2 for transfer.

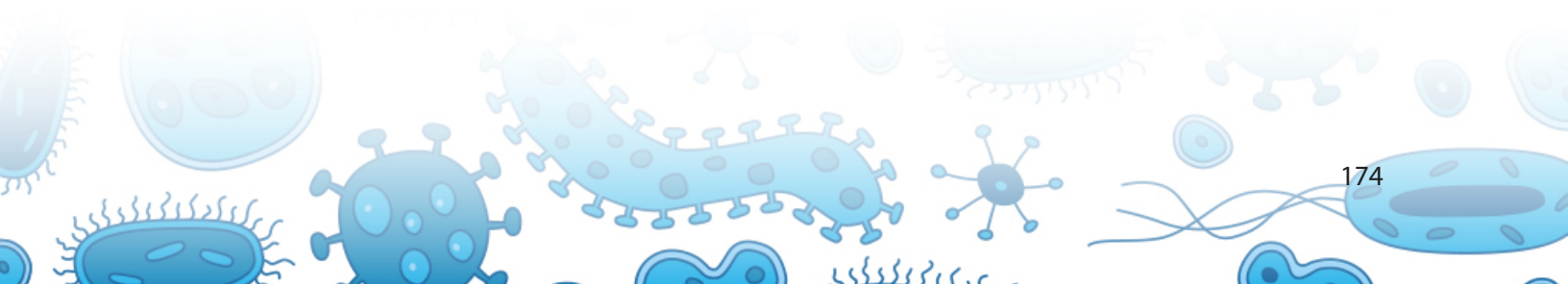

DESTRUCTION AND DECONTAMINATION

If the identification is confirmed then you must either transfer or destroy all remaining materials, patient samples, etc. within 7 days. Refer to the Biosafety, Biosecurity and Regulations section for directions on how to destroy, secure, or transfer the agent (See [DecontaminationSelectAgents JobAid 10 06 2015 Final Job Aid](#)). Work with your LRN Reference Laboratory on how to fill out the required paperwork.

EXPOSURES / MEDICAL/ CASE DEFINITION

There is no antidote or specific medical treatment. Any potential exposures should be immediately reported to the local health department and will require completion of CDC-APHIS Form 3. Refer to the Biosafety, Biosecurity, and Regulations Section for more information and guidance ([Form 3: APHIS/CDC Select Agent Job Aid](#)) or the Select Agent website (<http://www.selectagents.gov/form3.html>). You can also contact your LRN Reference Laboratory for assistance.

Accidental exposure to ricin is extremely unlikely, therefore it would take a deliberate act to make ricin and use it to poison people. There three routes of exposure for ricin: inhalation, ingestion, or injection. People can be poisoned by breathing in ricin mist or powder, swallowing food or water contaminated with ricin, or having a ricin pellet or ricin dissolved in a liquid injected into their bodies. Ricin poisoning is not contagious. It cannot be spread from person to person through casual contact.

The symptoms of ricin poisoning depend on the route of exposure and the dose received. Many organs may be affected in severe cases.

Death from ricin poisoning could take place within 36 to 72 hours of exposure, depending on the route of exposure (inhalation, ingestion, or injection) and the dose received. If death has not occurred in 3 to 5 days, the victim usually recovers.

- **Inhalation:** Initial symptoms of ricin poisoning by inhalation may occur within 8 hours of exposure. The likely symptoms would be respiratory distress (difficulty breathing), fever, cough, nausea, and tightness in the chest. Heavy sweating may follow as well as fluid building up in the lungs (pulmonary edema). This would make breathing even more difficult, and the skin might turn blue. Excess fluid in the lungs would be diagnosed by x-ray or by listening to the chest with a stethoscope. Finally, low blood pressure and respiratory failure may occur, leading to death.
- **Ingestion:** Following ingestion of ricin, initial symptoms typically occur in less than 6 hours. If someone swallows a significant amount of ricin, he or she would develop vomiting and diarrhea that may become bloody. Severe dehydration may be the result, followed by low blood pressure. Other signs or symptoms may include hallucinations, seizures, and blood in the urine. Within several days, the person's liver, spleen, and kidneys might stop working, and the person could die.
- **Skin and eye exposure:** Ricin in the powder or mist form could cause redness and pain of the skin and the eyes.

Note: Showing these signs and symptoms does not necessarily mean that a person has been exposed to ricin.

Quick Facts about Ricin

- Ricin is a highly toxic poison found naturally in castor beans, which are seeds from the plant *Ricinus communis*.
- Ricin is poisonous if ingested, inhaled or injected; the symptoms vary depending upon the route of exposure. It acts as a toxin by inhibiting protein synthesis.
- It is highly unlikely that individuals would be exposed unintentionally to ricin, unless they ingest the castor beans.
- Making ricin is a deliberate act meant to poison people.
- Due to its availability, the US has had several cases where ricin was used to kill or cause illness in others, and to create panic.
- Public Health Laboratories that are members of the LRN test for ricin and ricinine. Ricinine in urine indicates ricin exposure.
- Ricin poisoning is not contagious. It cannot be spread through casual contact. However, individuals could be exposed if they have contact with others who have the ricin toxin on their clothing.
- **There is no antidote or specific medical treatment. Victims receive supportive care to minimize the effects of the poison.**

References

CDC Ricin

<http://emergency.cdc.gov/agent/ricin/facts.asp>

Biosafety in Microbiological and Biomedical Laboratories

<http://www.cdc.gov/biosafety/publications/bmb15/>

Select Agent Program

<http://www.selectagents.gov/>

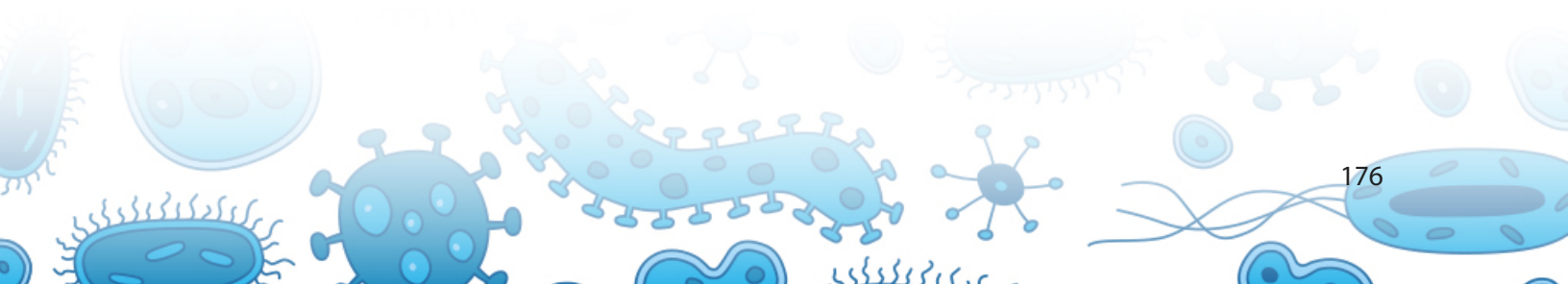

STAPHYLOCOCCAL ENTEROTOXIN B (SEB) *Staphylococcus aureus*

RECOMMENDATIONS FOR SAFE LABORATORY PRACTICES

Health care workers should exercise standard universal precautions; BSL-2 practices, PPE, containment equipment for aerosol generating activities, and facilities should be used when handling Staphylococcal enterotoxins or potentially contaminated material. The use of a laboratory coat, gloves and safety glasses is mandatory when handling toxin or toxin-contaminated solutions. Frequent and careful hand-washing and laboratory decontamination should be strictly enforced when working with Staphylococcal enterotoxin B (SEB). Depending upon a risk assessment of the laboratory operation, the use of a disposable facemask may be required to avoid accidental ingestion.

BSL-3 facilities, equipment, and practices are indicated for activities with a high potential for aerosol or droplet production and those involving the use of large quantities of SEB. Refer to the Biosafety, Biosecurity and Regulations section contained within this guidance manual, the Biosafety in Microbiological and Biomedical Laboratories (BMBL) (<http://www.cdc.gov/biosafety/publications/bmb15/>) and Guidelines for Safe Work Practices in Human and Animal Medical Diagnostic Laboratories (<http://www.cdc.gov/mmwr/preview/mmwrhtml/su6101a1.htm>) for more information.

DATE APPROVED:

8 / 1 / 2016

SAFETY CONSIDERATIONS:

According to the biosafety in microbiological and biomedical laboratories (BMBL) 5th edition, the most common cause of laboratory SEB intoxication is expected to result from accidental self-exposure via the mucous membranes by touching contaminated hands to the face or eyes.

DISEASE TRANSMISSION AND CLINICAL PRESENTATION

Staphylococcal enterotoxin B is an extracellular protein toxin produced by the bacterium *Staphylococcus aureus*. Although SEB has been associated with foodborne illness, SEB has been weaponized in several countries for its use as a biological weapon. *Staphylococcus aureus* can be found worldwide and food intoxication is both widespread and relatively common. SEB toxin may be acquired by either food, water, or an aerosol resulting in a temporary, highly incapacitating illness rather than death. Staphylococcus enterotoxin B is designated as Select Agent according to Federal Select Agents and Toxins Regulations. Federal regulations can be viewed at <http://www.selectagents.gov/>. If a bioterrorism incident is suspected, clinical specimens and culture isolates should be referred to your local public health LRN reference lab and notification of the local health department should be done immediately.

See the ASM Staphylococcal Enterotoxin B guidelines for additional information at <http://www.asm.org/index.php/science-skills-in-the-lab/sentinel-guidelines>

LABORATORY TESTING INFORMATION

Exposure to SEB as a result of a bioterrorist event may include exposure to the enterotoxin alone or both the organism *S. aureus* and the enterotoxin. The diagnosis of SEB intoxication is primarily clinical, with confirmation by epidemiologic assays of environmental or clinical specimens. Routine laboratory findings are nonspecific and therefore not helpful in the diagnosis of SEB intoxication. Specialized testing is currently performed in select laboratories which may include polymerase chain reaction (PCR) to detect SEB gene sequences in environmental, food, and clinical specimens, or enzyme immunoassay (EIA) to detect the toxin in food and toxin production by *S. aureus* isolates. Culture may also be performed on any sample type. Contact your assigned LRN laboratory for testing assistance. Refer to the ASM Sentinel Level Clinical Laboratory Protocols for more detailed information: <http://www.asm.org/index.php/science-skills-in-the-lab/sentinel-guidelines>. For additional testing information, please contact your local LRN Reference Laboratory.

ACCEPTABLE SAMPLE TYPES

Culture isolate – Prepare fresh subculture on agar slant or transport swab. Store at room temperature and transport at 2-8°C.

Clinical - Contact your designated LRN Reference level laboratory for specific guidance prior to specimen collection.

Food - Sentinel laboratories should forward these specimens directly to an LRN Reference or FERN laboratory. Specimens should be stored and transported at 2-8°C.

Environmental (non-food) - **Sentinel facilities should not attempt to collect these samples.** Contact your designated LRN Reference level laboratory for guidance.

REPORTING AND NOTIFICATION TO STATE OR LOCAL PUBLIC HEALTH

Suspect cases should be immediately reported to the local health department for investigation. Prior to submitting specimens for testing, your LRN Reference Laboratory must be contacted for specimen submission guidance and to provide test notification. For confirmed cases, clinical laboratories must always refer to their State / Local and Federal disease notification and reporting requirements. See your state specific contact information in the State Section and the following link for Federal guidelines. <http://www.selectagents.gov/>

SHIPPING AND TRANSFERS

Upon notification to the local health department epidemiology program and coordination with your local Public Health LRN Reference Laboratory of a suspected bioterrorism event involving *Staphylococcus enterotoxin B*, laboratories should be prepared to properly package and ship the sample(s). If a culture is being submitted for LRN Rule-Out Testing, the shipment should be classified, handled, packaged and transported as "Suspected Category A." Please note that SEB is a select agent

requiring registration with the Select Agent and Toxin Division for possession, use, storage and/or the transfer of confirmatory material and will require a CDC/APHIS Form 2 for transfer. See the *Packaging and Shipping* Section contained within this guidance manual for additional information about sample classification and shipping procedures.

DESTRUCTION AND DECONTAMINATION

To ensure complete inactivation, contaminated items should be steam autoclaved at $>121^{\circ}\text{C}$ for one hour (2 hours for volumes greater than 1 liter) and then incinerated. Contaminated surfaces should be treated with fresh 0.5% hypochlorite for 15 minutes (<http://www.cdc.gov/biosafety/publications/bmb15/>).

Staphylococcus enterotoxin B is a Select Agent. If the identification of Staphylococcus enterotoxin B is confirmed then you must either transfer or destroy all remaining materials, isolates, patient samples, etc. within 7 days. Refer to the Biosafety, Biosecurity and Regulations section for directions on how to destroy, secure, or transfer the agent (See [DecontaminationSelectAgents JobAid 10 06 2015 Final Job Aid](#)). Work with your LRN Reference Laboratory on how to fill out the required paperwork.

EXPOSURES / MEDICAL/ CASE DEFINITION

There is no approved vaccination or specific antidote currently available for human use.

Any potential exposure should be immediately reported to the local health department and will require the completion of CDC-APHIS Form 3. Refer to the Biosafety, Biosecurity, and Regulations Section for more information and guidance ([Form 3: APHIS/CDC Select Agent Job Aid](#)) or the Select Agent website (<http://www.selectagents.gov/form3.html>). You can also contact your LRN Reference Laboratory for assistance.

REFERENCES

<http://www.cdc.gov/biosafety/publications/bmb15/>

<http://www.asm.org/index.php/science-skills-in-the-lab/sentinel-guidelines>

<http://www.selectagents.gov/>



VIRAL HEMORRHAGIC FEVERS (VHF)

RECOMMENDATIONS FOR SAFE LABORATORY PRACTICES

Recommendations for safely collecting and transporting specimens remain unchanged. The essential specimens to be submitted for virus isolation are a sample of venous blood, a midstream ("clean catch") specimen of urine, and a throat swab. If postmortem specimens are available, serum, liver, spleen, and kidney tissue are desirable. The following procedures should be followed:

1. Glass containers should not be used. Disposable sharp objects, such as scalpel blades, also should not be handled unnecessarily after use and should be autoclaved or incinerated.
2. Venous blood samples must be collected with extreme care to avoid self-inoculation. 10 mL of clotted blood should be placed in a sealed plastic container. Needles should not be recapped, bent, broken, removed from disposable syringes, or otherwise handled. Blood-taking equipment should be put in a rigid plastic container filled with disinfectant solution and autoclaved or incinerated.
3. Midstream urine specimens should be collected by clean catch. Five milliliters of urine should be put in a plastic screw-cap container with one of the following: rabbit serum albumin diluted to a final concentration of 25%, human serum albumin diluted to a 1% concentration, or bovine serum albumin at a final concentration of 10%.
4. Throat swabs should be placed in plastic screw-cap containers in 1 mL of sterile, phosphate-buffered neutral saline containing 25% rabbit serum, 1% human serum albumin, or 10% bovine serum albumin.

DATE APPROVED:

8 / 1 / 2016

SAFETY CONSIDERATIONS:

As soon as any Viral Hemorrhagic Fever is suspected, Contact your State or County Health Departments. ALL laboratory work must be completed in a Class II Biological Safety Cabinet (BSC) following BSL-3 practices and in the CDC recommended PPE.

The outside of each specimen container should be swabbed with disinfectant, and a label should be attached bearing the patient's name, hospital identification, the date of collection, and the nature of the suspected infection. Then, the specimens should be double-bagged in secure, airtight and watertight bags, which have been similarly labeled. Bags containing specimens should be sponged with disinfectant before they are removed from the patient's room.

MOBILE LABORATORY

CDC has adapted a mobile isolator that can be used as a portable laboratory to investigate cases of suspected or confirmed VHF safely. This facility can be transported immediately to any part of the United States, with an accompanying technician and physician experienced in dealing with

hemorrhagic fevers. The mobile laboratory has facilities for routine hematologic and biochemical studies, as well as for basic bacteriologic and coagulation investigations. Serodiagnostic tests for VHF can be performed in this facility, but cultures for virus isolation cannot. Electrolyte measurements on inactivated serum specimens are also possible, but blood gas analysis is not. Early use of this facility is preferable to delays in investigating the suspected case because of concern about the hazards of handling specimens. Further information about the mobile laboratory and its use can be obtained from the persons listed in the Introduction.

DISEASE TRANSMISSION AND CLINICAL PRESENTATION

Viral hemorrhagic fevers (VHFs) refer to a group of illnesses that are caused by several distinct families of viruses. In general, the term "viral hemorrhagic fever" is used to describe a severe multisystem syndrome (multisystem in that multiple organ systems in the body are affected) where the overall vascular system is damaged, and the body's ability to regulate itself is impaired.

Symptoms are often accompanied by hemorrhage (bleeding); however, the bleeding itself is rarely life-threatening. While some types of hemorrhagic fever viruses can cause relatively mild illnesses, many of these viruses cause severe, life-threatening disease.

Most hemorrhagic fever viruses are classified as risk group 4 (refer to the BMBL for more information) pathogens and isolates must be handled in a BSL-4 laboratory. A list of these viruses appears in the Special Pathogens Branch disease information index:

www.cdc.gov/ncezid/dhcpp/vspb/diseases.html. The two non-risk group 4 viruses that cause hemorrhagic fevers are Dengue Hemorrhagic Fever and Yellow Fever.

Most VHFs are zoonotic. This means that these viruses naturally reside in an animal reservoir host or arthropod vector. They are totally dependent on their hosts for replication and overall survival. For the most part, rodents and arthropods are the main reservoirs for viruses causing VHFs. Viruses that cause

VHFs are distributed over much of the globe. However, because each virus is associated with one or more particular host species, the virus and the disease it causes are usually seen only where the host species live(s).

Viruses causing hemorrhagic fever are initially transmitted to humans when the activities of infected reservoir hosts or vectors and humans overlap. The viruses carried in rodent reservoirs are transmitted when humans have contact with urine, fecal matter, saliva, or other body excretions from infected rodents. The viruses associated with arthropod vectors are spread most often when the vector mosquito or tick bites a human, or when a human crushes a tick. However, some of these vectors may spread virus to animals, livestock, for example. Humans then become infected when they care for or slaughter the animals.

Some viruses that cause hemorrhagic fever can spread from one person to another, once an initial person has become infected. Ebola, Marburg, Lassa and Crimean-Congo hemorrhagic fever viruses are examples. See additional section for Ebola specific instructions. This type of secondary transmission of

the virus can occur directly, through close contact with infected people or their body fluids. It can also occur indirectly, through contact with objects contaminated with infected body fluids. For example, contaminated syringes and needles have played an important role in spreading infection in outbreaks of Ebola hemorrhagic fever and Lassa fever.

VHF SYMPTOMS

Specific signs and symptoms vary by the type of VHF, but initial signs and symptoms often include marked fever, fatigue, dizziness, muscle aches, loss of strength, and exhaustion. Patients with severe cases of VHF often show signs of bleeding under the skin, in internal organs, or from body orifices like the mouth, eyes, or ears.

Although they may bleed from many sites around the body, patients rarely die because of blood loss. Severely ill patient cases may also show shock, nervous system malfunction, coma, delirium, and seizures. Some types of VHF are associated with renal (kidney) failure.

World Health Organization (WHO)

http://www.who.int/topics/haemorrhagic_fevers_viral/en/

Centers for Disease Control & Prevention (CDC)

<http://www.cdc.gov/vhf/ebola/healthcare-us/laboratories/specimens.html>

<http://www.cdc.gov/vhf/index.htm>

ASM

<http://www.asm.org/index.php/science-skills-in-the-lab/sentinel-guidelines>

APHL

<http://www.cdc.gov/ncezid/dhcpp/vspb/specimens.html>

VHF SUBMISSION INFORMATION (CDC/EOC)

Review the CDC guidelines to submit specimens to CDC. Forms are available or call the CDC's Emergency Operations Center (http://www.cdc.gov/phpr/eoc_responses.htm) at 770-488-7100. Consult with your state Public Health Department before sending any specimens to CDC.

PACKAGING & SHIPPING REQUIREMENTS

Upon notification to the local health department epidemiology program and coordination with your local Public Health LRN Reference Laboratory of a suspected VHF, laboratories should be prepared to properly package and ship the sample(s). If a sample is being submitted for suspected VHF testing, the shipment should be classified, handled, packaged and transported as "Suspected Category A." A sample that has already been identified or if there is a high likelihood of VHF, then the term "suspect" can no longer be used. It must be classified as Category A. Some carriers will not accept Risk Group 4

organisms (e.g., VHF), so always consult with your carrier. Please note that an organism with a confirmed select agent identification will require a CDC/APHIS Form 2 for transfer.

See the Packaging and Shipping section for detailed instructions on how to ship this specimen to your LRN Reference Laboratory.

EBOLA SPECIFIC GUIDANCE

Ebola was first discovered in 1976 near the Ebola River in what is now the Democratic Republic of the Congo. Since then, outbreaks of Ebola among humans have appeared sporadically in Africa.

The 2014 Ebola epidemic is the largest in history with 27,636 cases and 11,268 deaths to date and affecting multiple countries in West Africa (Guinea, Sierra Leone, and Liberia). In the United States there were two imported cases, including one death, and two locally acquired cases in healthcare workers.

EXPOSURES

Family members or healthcare providers caring for Ebola patients and others who have close contact are at the greatest risk of contracting the disease because of the potential of coming in contact with infected blood or body fluids. Ebola also can be spread through direct contact with objects contaminated with infected blood or body fluids (like clothes, bedding, needles, syringes/sharps or medical equipment).

Additionally, people can become sick with Ebola after coming in contact with infected wildlife or after handling meat from an infected animal.

New evidence also suggests that it is possible that Ebola could be spread through sex or other contact with semen from men who have survived Ebola. It is not known if Ebola can be spread through sex or other contact with vaginal fluids from a woman who has had Ebola.

<http://www.cdc.gov/vhf/ebola/exposure/index.html>

REPORTING AND NOTIFICATION TO STATE OR LOCAL PUBLIC HEALTH

Suspect cases of EVD should be immediately reported to the local health department for investigation. Prior to submitting specimens for testing, your public health laboratory must be contacted for specimen submission guidance and to provide test notification. For confirmed cases, clinical laboratories must always refer to their State or Local disease notification and reporting requirements. See your state specific contact information in the State Section and the following link for Federal guidelines. <http://www.selectagents.gov/>

Specimens should be obtained when a patient meets the criteria for person under investigation (PUI) including patients with clinical signs, symptoms, and [epidemiological risk factor](#) (exposure opportunities) for Ebola virus disease. If the first specimen is obtained 1-3 days after the onset of

symptoms and tests negative and the patient remains symptomatic without another diagnosis, a later specimen may be needed to rule-out Ebola virus infection.

ACCEPTABLE SAMPLE TYPES

For adults, a minimum volume of 4 mL whole blood is preferable. For pediatric samples, a minimum of 1 mL whole blood should be collected in pediatric-sized collection tubes. Blood must be collected in **plastic** collection tubes. Do not transport or ship specimens in glass containers or in heparinized tubes.

Whole blood preserved with EDTA is preferred, but whole blood preserved with sodium polyanethol sulfonate, citrate or with clot activator is also acceptable.

Do not separate and remove serum or plasma from the primary collection container.

Specimens should be packaged and transported at 2°–8°C with cold-packs to the final testing destination.

Specimens other than blood may be submitted after consultation with CDC by calling the EOC at 770-488-7100.

STORING CLINICAL SPECIMENS FOR EBOLA TESTING

If necessary, short-term storage of specimens before shipping should be at 4°C or frozen.

DIAGNOSTIC TESTING FOR EBOLA VIRUS

Real-time PCR testing for Ebola virus is available at over 50 LRN Reference Laboratories located throughout the United States. LRN Reference Laboratories are currently using an FDA approved Emergency Use Only (EUA) assay to detect the Ebola (Zaire species) virus. Samples that test positive using this assay are considered presumptive positive for Ebola Zaire RNA by real time RT-PCR and should be submitted to CDC for additional evaluation.

SHIPPING AND TRANSFERS

Upon notification to the local health department epidemiology program and coordination with your local Public Health LRN Reference Laboratory of a suspected EVD case, laboratories should be prepared to properly package and ship the sample(s).

PPE to be worn during transport within the facility should be determined by a site-specific risk assessment, and may vary among facilities. Recommendations for PPE include disposable fluid-resistant closed lab coat, disposable gloves, covered legs and closed-toed shoes.



Before removing patient specimens from the site of care, it is advisable to plan the route of the sample from the patient area to the location where it will be packed for shipping in order to avoid high traffic areas.

Before removing patient specimens from the site of care, the outside of the specimen containers should be decontaminated with an approved disinfectant as described in [Interim Guidance for Environmental Infection Control in Hospitals for Ebola Virus](#).

In compliance with OSHA Bloodborne Pathogens Standard ([29 CFR 1910.1030](#)), specimens should be placed in a durable, leak-proof secondary container.

After placing in a secondary container, specimens should be hand-carried to the laboratory or packing area. DO NOT use any pneumatic tube system (automated or vacuum specimen delivery system) for transporting specimens.

TRANSPORTING SPECIMENS FOR EBOLA TESTING TO SITES OUTSIDE THE FACILITY

Samples from patients that are suspected of or confirmed to have Ebola virus infection should be packaged and shipped as Category A infectious substances in accordance with the DOT's [Hazardous Materials Regulations \(HMR\) 49 CFR 171-180](#).

All persons packing and shipping infectious substances must be trained and certified in compliance with DOT or the [International Air Transport Association](#) (IATA) requirements every two years.

Specimens collected for Ebola virus testing should be packed and shipped without attempting to open collection tubes or aliquot specimens. Opening the tubes destroys the vacuum seal and thus increases the risk of leakage during transport. See the Packaging and Shipping section for detailed instructions on how to ship this specimen to your LRN Reference Laboratory.

WHEN TO CONTACT CDC

Hospitals should contact their state and/or local health department before contacting CDC. CDC is available for consultation at 770-488-7100.

CDC will continue to evaluate new information as it becomes available and will update this guidance as needed.

DESTRUCTION AND DECONTAMINATION

Note: Recommended disinfectants are those known to kill non-enveloped viruses and can be found in List L of EPA's [Disinfectants for Use Against the Ebola Virus](#). This list of registered disinfectants meets the CDC's criteria for use against the Ebola virus on hard, non-porous surfaces.

The Public Health Agency of Canada has created Pathogen Safety Data Sheets for numerous human pathogens. These technical documents are intended to describe the hazardous properties of listed organisms and recommendations for work involving these agents in a laboratory setting. A complete list of the organisms as well as other safety related information is available here:

<http://www.phac-aspc.gc.ca/lab-bio/res/psds-ftss/index-eng.php>.

If the identification is confirmed then you must either transfer or destroy all remaining materials, isolates, patient samples, etc. within 7 days. Refer to the Biosafety, Biosecurity and Regulations section for directions on how to destroy, secure, or transfer the agent (See [DecontaminationSelectAgents JobAid 10 06 2015 Final Job Aid](#)). Work with your LRN Reference Laboratory on how to fill out the required paperwork.

ADDITIONAL RESOURCES AND INFORMATION

[Instructions for Submitting Diagnostic Specimens to CDC's Viral Special Pathogens Branch](#)

[Viral Special Pathogens Branch Specimen Submission Information \[PDF - 2 pages\]](#)

[Infection Prevention and Control Recommendations for Hospitalized Patients with Known or Suspected Ebola Virus Disease in U.S. Hospitals](#)

[HAN 364: Guidelines for Evaluation of US Patients Suspected of Having Ebola Virus Disease](#)

[Guidelines for Disinfection and Sterilization in Healthcare Facilities, 2008](#)

[Guidelines for Safe Work Practices in Human and Animal Medical Diagnostic Laboratories \[PDF - 105 pages\]](#)

[Submitting Specimens to CDC Specimen Submission Form](#)

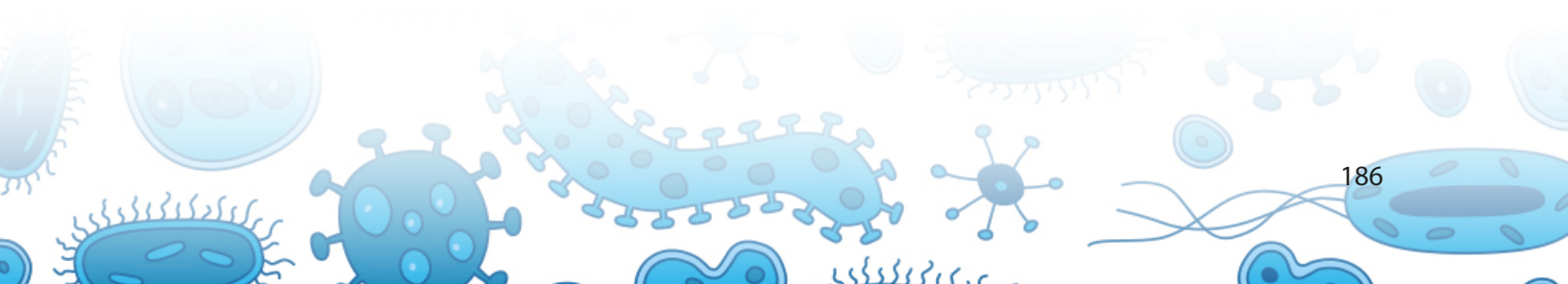

Guidance for Collection, Transport, and Submission of Specimens for Ebola Virus Testing in the United States

NOTIFICATION & CONSULTATION

Hospitals should follow their state and/or local health department procedures for notification and consultation for Ebola testing requests.

WHEN SPECIMENS SHOULD BE COLLECTED FOR EBOLA TESTING



Ebola virus is detected in blood only after the onset of symptoms, usually fever. It may take up to 3 days after symptoms appear for the virus to reach detectable levels. Virus is generally detectable by real-time PCR from 3 to 10 days after symptoms appear.

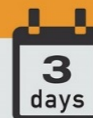

Ideally, specimens should be taken when a symptomatic patient reports to a healthcare facility and is suspected of having an exposure to Ebola. However, if the onset of symptoms is <3 days, a later specimen may be needed to completely rule-out Ebola virus, if the first specimen tests negative.

PREFERRED SPECIMENS FOR EBOLA TESTING

A minimum volume of 4 mL of whole blood preserved with EDTA is preferred but whole blood preserved with sodium polyanethol sulfonate, citrate, or clot activator can be submitted for Ebola testing.

Specimens should be shipped at 2-8°C or frozen on cold-packs. Do not submit specimens in glass containers to CDC. Do not submit specimens preserved in heparin tubes.



Specimens other than blood may be submitted after consult with CDC.



DIAGNOSTIC TESTING FOR EBOLA VIRUS

Real-time PCR testing for Ebola virus is available at more than 50 Laboratory Response Network (LRN) laboratories located throughout the United States. LRN laboratories are currently using an FDA-approved Emergency Use Authorization assay to detect the Ebola virus (species *Zaire ebolavirus*). Samples that test positive using this assay are considered presumptive positive for Ebola Zaire RNA by real-time PCR and should be submitted to CDC for additional evaluation.

TRANSPORTING SPECIMENS WITHIN THE HOSPITAL / INSTITUTION



In compliance with 29 CFR 1910.1030, specimens should be placed in a durable, leak-proof secondary container for transport within a facility. To reduce the risk of breakage or leaks, do not use any pneumatic tube system for transporting suspected Ebola virus specimens.

PACKAGING & SHIPPING CLINICAL SPECIMENS

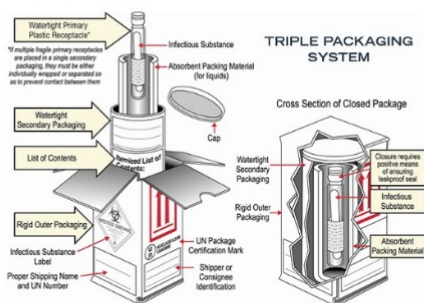

Specimens collected for Ebola virus testing should be packaged and shipped without attempting to open collection tubes or aliquot specimens.

Specimens for shipment should be packaged following the basic triple packaging system that consists of a primary sealable container wrapped with absorbent material, secondary container (watertight, leak-proof), and an outer shipping package.

State guidelines may differ and state or local health departments should be consulted before shipping. Ebola virus is classified as a Category A infectious substance by the Department of Transportation (DOT). Specimens from persons under investigation for Ebola or from patients confirmed to have Ebola virus disease should be packaged and shipped as Category A infectious substances.

Packing and shipping Category A infectious substances must be performed by people trained and certified in compliance with DOT or International Air Transport Association requirements. For guidance on packaging and shipping, refer to [Guidance for Collection, Transport and Submission of Specimens for Ebola Virus Testing in the United States](#) and the DOT Hazardous Materials Information Center at 1-800-467-4922.

INFORMATION ON SHIPPING & TRACKING IS AVAILABLE AT

www.cdc.gov/vhf/ebola/healthcare-us/laboratories/index.html



C254211-B

PACKAGING AND SHIPPING

Introduction.....	190
Regulatory Overview.....	190
Required Trainings.....	198
Transport.....	203
Diagram 1. IATA and U.S. Postal Service Classification Flowchart Guidance.....	205
Diagram 2. DOT Classification Flowchart Guidance.....	206
Table 2. IATA and DOT Indicative Category A List.....	208
Table 3. Packing Requirements for Exempt Human Specimens, Category B Substances, and Category A Substances.....	211
Diagram 3. Exempt Human Specimen and Exempt Animal Specimen Packaging Example.....	215
Diagram 4. Exempt Specimen Outer Package Example.....	216
Diagram 5. Exempt Specimen with Dry Ice Outer Package Example.....	216
Diagram 6. Exempt Human Specimen Label Example.....	217
Diagram 7. Biological Substance, Category B Packaging Example.....	218
Diagram 8. Biological Substance, Category B Label Example.....	218
Diagram 9. Biohazard Label Example for Inner Secondary Container.....	219
Diagram 10. Biological Substance, Category B with Dry Ice Outer Package Example.....	219
Diagram 11. Category A Infectious Substance Outer Packaging Example.....	221
Diagram 12. Category A Infectious Substance with Dry Ice Outer Packaging Example.....	222
Diagram 13. Category A, Infectious Substance Class 6 Hazard Label Example.....	222
Diagram 14. Category A Label Change Notice.....	223
Diagram 15. Biohazard Label.....	223
Diagram 16. UN Certification Markings.....	224
Diagram 17. Dry Ice Label Change Notice.....	226
Diagram 18. Dry Ice Label Example.....	227
Diagram 19. Overpack Label Example.....	227
Shipper's Declaration for Dangerous Goods Overview.....	230
Diagram 20. FedEx Shipper's Declaration for Dangerous Goods Form Example.....	231
Transfers and Permits.....	237

Guidance.....	239
Supplies.....	242
Diagram 21. UN Symbol Marking Example	244
Table 4. Category A Supplies Table.....	245
Table 5. Category B Supplies Table.....	246
Table 6. Overpack Supplies Table.....	246
Table 7. Dry Ice B Supplies Table	246
Table 8. Summary Table.....	248
WHO A Guide for Shippers of Infectious Substances, 2015-2016.....	249
Checklist 1. Category A Guidance Checklist	250
Checklist 2. Shipper’s Declaration Guidance Checklist.....	252
Checklist 3. FedEx Shipper’s Declaration Checklist.....	254
Checklist 4. FedEx Shipper’s Declaration Verification Checklist.....	256
Checklist 5. Category B Guidance Checklist.....	258
Checklist 6. Dry Ice Guidance Checklist.....	260
Checklist 7. Overpack Guidance Checklist.....	262
Checklist 8. Exempt Specimen Guidance Checklist	263
Category A List vs. Select Agent List Comparison job aid.....	265



INTRODUCTION

Laboratorians, specimen processors, and other shipping personnel who package or ship infectious or other hazardous material (Shipper/Sender) are responsible for being aware of current and applicable regulations, requirements, and any updates. Shippers are responsible for correctly classifying and packaging the material(s) for the purpose of protecting the public, personnel in the transportation industry, emergency responders, as well as other laboratory or healthcare staff from accidental exposure to the contents of the packages. The responsibility to correctly package and ship infectious material is that of the sender, not the recipient or consignee.

DATE APPROVED:

8 / 1 / 2016

Correctly preparing a hazardous package is accomplished by complying with specific federal, state and carrier requirements and regulations. The following guidance is not intended to be an all-inclusive guide to packing and shipping regulations, but will describe basic packaging and shipping of dangerous goods, which may pose an unreasonable risk to health and safety when transported in commerce. This guidance is specifically intended to be an overview for Sentinel Laboratories submitting potential biothreat agents or other infectious material to Public Health and Laboratory Response Network (LRN) Reference Laboratories, but will also serve useful to anyone packaging and shipping infectious material. Therefore, adherence to the listed regulations and requirements will minimize the potential for damage to the contents of the package during transport, will reduce the potential risks of exposure to the contained material, and will reduce the risks of potential criminal and civil liability associated with the improper shipment of dangerous goods.

REGULATORY OVERVIEW

Hazardous material regulations cover a wide range of hazards, substances, means of transport, and are governed by several regulatory agencies. This guidance will demonstrate how infectious substances are classified as hazardous material and how they must conform to all applicable regulations and requirements. The requirements and regulations governing the transport of infectious substances are developed and published by many authorities and commercial carriers, and are revised frequently. Shippers are responsible for being aware of these changes, being appropriately trained and certified, adhering to current regulations, interpreting applicable regulations for themselves and their facilities, and packing and shipping infectious substances appropriately.

Most regulations for air transport of dangerous goods throughout the world originate as Model Regulation decisions developed by the United Nations (UN). The International Civil Aviation Organization (ICAO) uses these Model Regulations to develop formal and standardized Technical Instructions for the Safe Transportation of Dangerous Goods by Air for use in international aviation. These Technical Instructions are the standards for the international shipment of dangerous goods by air.

The International Air Transport Association (IATA) uses the Technical Instructions to develop the Dangerous Goods Regulations (DGR). The IATA DGR requirements have become the most widely

recognized, copied, and used packing and shipping guidelines in the world. Most national and international regulations are based on, or are at least in substantial agreement (harmonization) with IATA DGR requirements. For the purposes of air transport of infectious substances in the U.S., shippers observing and maintaining compliance with the IATA requirements will also help ensure compliance with U.S. Department of Transportation (DOT) Hazardous Material Regulations (HMR).

In the United States, the DOT regulates the commercial transportation of dangerous goods by both air and ground carriers. Just as IATA derives its requirements from ICAO, the DOT also derives its regulations from ICAO. IATA requirements and DOT regulations mandate the minimum standards for packing infectious substances that could pose a threat to humans, animals or the environment. The safe and legal transport of infectious substances is based on the following primary goals for protecting the shipper, transporter, recipient, and the public from exposure to the infectious materials; these goals are outlined in the following mandated activities:

- Training and Certification
- Hazard Classification
- Appropriate Packaging
- Proper Labeling and Marking
- Documentation
- Transport
- Incident and Emergency Response

The following groups are associated with infectious substance shipping regulations and requirements:

CDC – CENTERS FOR DISEASE CONTROL & PREVENTION

The Centers for Disease Control and Prevention (CDC) regulates the importation of infectious biological agents, infectious substances, and vectors of human disease into the United States through its Import Permit Program (IPP). Further information regarding permits is contained below in the *Transfer & Permits Section*.

The CDC also oversees the transportation of all Select Biological Agents and Toxins in the U.S. Information regarding the Select Biological Agents and Toxin regulations is available here:

<http://www.selectagents.gov/regulations.html>.

Facilities that possess select agents must have a written Hazardous Material Security Plan in place on site. Additional information about Hazardous Material Security Plan requirements is listed in the *DOT Section* and in the *Training Section* of this guidance.

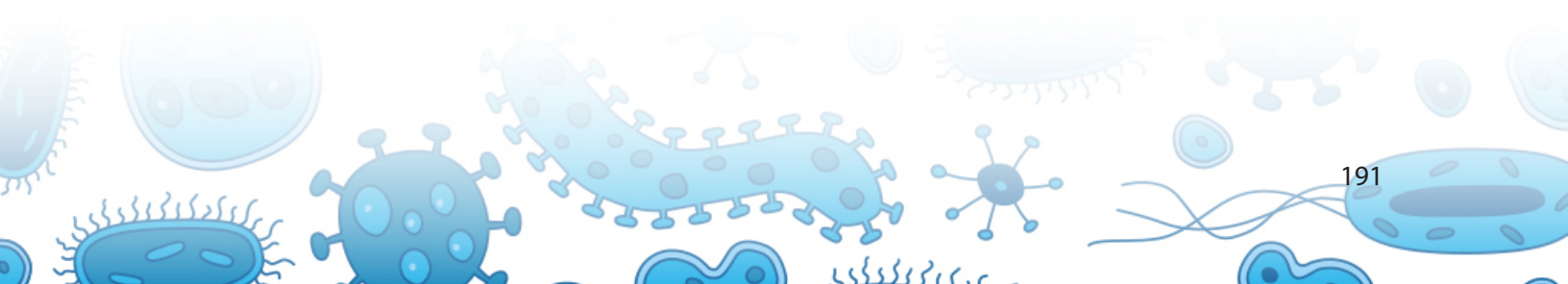

DOT - UNITED STATES DEPARTMENT OF TRANSPORTATION

The United States Department of Transportation (DOT) is the Federal agency which regulates domestic transportation of all hazardous material into and within the U.S. through regulations published in the Federal Register known as the Code of Federal Regulations (CFR). DOT issues the Hazardous Material Regulations (HMR) which applies to any material DOT determines is capable of posing an unreasonable risk to health, safety and property when transported in commerce. DOT designates nine classes of hazardous material as listed in Table 1:

Table 1. DOT Hazard Class Table	
Hazard Class 1: Explosives	1.1 Mass explosion hazard 1.2 Projectile hazard 1.3 Minor blast/projectile/fire 1.4 Minor blast 1.5 Insensitive explosives 1.6 Very insensitive explosives
Hazard Class 2: Gases	2.1 Flammable gases 2.2 Non-flammable compressed gases 2.3 Poisonous gases
Hazard Class 3: Flammable Liquid and combustible Liquid	Flammable (flash point below 141°F) Combustible (flash point 141°-200°F)
Hazard Class 4: Flammable Solid, Spontaneously Combustible, and Dangerous When Wet	4.1 Flammable solids 4.2 Spontaneously combustible 4.3 Dangerous when wet
Hazard Class 5: Oxidizers and Organic Peroxides	5.1 Oxidizer 5.2 Organic Peroxide
Hazard Class 6: Poison (Toxic) and Infectious Materials	6.1 Material that is poisonous 6.2 Infectious Substances
Hazard Class 7: Radioactive Material	Radioactive I Radioactive II Radioactive III
Hazard Class 8: Corrosive Material	Destruction of the human skin Corrode steel at a rate of 0.25 inches per year
Hazard Class 9: Miscellaneous	A material that presents a hazard during shipment but does not meet the definition of the other classes (example dry ice)

An infectious substance is classified and regulated as a Class 6, Division 6.2 Hazardous Material under the DOT's Hazardous Materials Regulations (HMR; 49 CFR § 171-180). Division 6.2 Materials are defined as any material known or reasonably expected to contain a pathogen, such as bacteria, viruses, parasites, or fungi that can cause disease in humans or animals. An infectious substance must conform to all applicable HMR requirements when offered for transportation or transported by air, highway, rail, or water. In the United States, the DOT regulates the commercial transportation of dangerous goods by both air and ground carriers. In addition to Division 6.2 infectious material, laboratorians may also commonly ship Class 9 Miscellaneous material such as dry ice, and Class 3 Flammable or Combustible material such as Ethanol or Methanol when included as refrigerants or preservatives.

The HMR are found in Title 49 of the Code of Federal Regulations, § 100 – 185 as:

- **49 CFR Part § 171-** General information, regulations and definitions
- **49 CFR part § 172-** Hazardous materials table, special provisions, hazardous material communications, emergency response information and training requirements
- **49 CFR part § 173-** Shippers general requirements for shipments and packaging
- **49 CFR Part § 174-** Carriage by Rail
- **49 CFR Part § 175-** Carriage by Aircraft
- **49 CFR Part § 176-** Carriage by Vessel
- **49 CFR Part § 177-** Carriage by Public Highway
- **49 CFR Part § 178-** Specifications for Packaging
- **49 CFR Part § 179-** Specifications for Tank Cars
- **49 CFR Part § 180-** Continuing Qualification and Maintenance Packaging

DOT can issue revisions or updates to the CFR's at any time and regulations may not be revised annually. However they will issue notices and effective dates when changes are made. It is the Shipper's responsibility to stay current and to not rely solely on previously provided training materials. Revisions to the HMR may be found on the DOT/PHMSA website under "rule making" available from their website here: <http://www.phmsa.dot.gov>.

A person who knowingly violates a requirement of the Federal hazardous material transportation law is liable for a civil penalty of not more than \$50,000 and not less than \$250 for each violation, except the maximum civil penalty is \$100,000 if the violation results in death, serious illness or severe injury to any person or substantial destruction of property. A minimum \$450 civil penalty applies to a violation relating to training. When the violation is a continuing one, each day of the violation constitutes a separate offense. Violations of any hazardous materials regulations including training may be subject to a civil penalty of up to \$50,000 for each violation. If the violation results in death, serious illness or severe injury to any person or substantial destruction of property, the maximum civil penalty is \$100,000. Criminal violations may result in fines, imprisonment or both. See 49 CFR § 107.329 (maximum penalties) and § 107.333 for further details.

A written Hazardous Material Security Plan must be developed and implemented by facilities meeting the requirements based on the certain types or quantities of hazardous materials that may be present

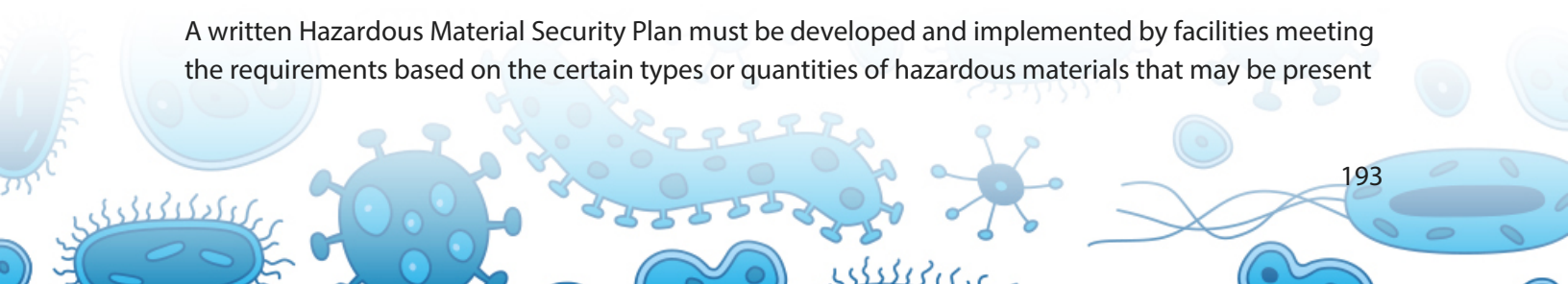

at the facility or offered for transport from the facility. Facilities in possession of Select Biological Agents and Toxins are required to have a written Hazardous Material Security Plan. For a complete listing of the other types and quantities requiring a HazMat Security Plan, as well as related guidance, please visit: <http://www.fmcsa.dot.gov/regulations/hazardous-materials/how-comply-federal-hazardous-materials-regulations>.

State and Federal DOT Inspectors may inspect any facility transporting or offering for transport hazardous materials to ensure regulatory compliance, and inspections may be unannounced.

The complete DOT Hazardous Material Regulations (HMR) can be found here: <http://phmsa.dot.gov/regulations> and the DOT Hazardous Material info line for additional assistance is: 1-800-467-4922.

FAA – FEDERAL AVIATION ADMINISTRATION

While the Federal Aviation Administration (FAA) has the authority to direct flight operations in United States airspace, any decision to restrict flights between the United States and other countries due to public health and disease concerns would be an interagency decision that would engage the Departments of Health and Human Services/CDC, State, Homeland Security, and Transportation. The FAA enforces the Hazardous Material Regulations in aviation. Passengers violating the HMR can be fined from \$250 to \$50,000. Those who intentionally violate the regulations are subject to a criminal penalty of up to \$500,000 and/or five years imprisonment.

The FAA can inspect facilities transporting by air, or offering for transport by air hazardous materials. Typically inspections will be based on records (e.g., Dangerous Goods Shipper's Declarations for Category A Infectious Substances) reviewed at commercial carrier facilities. FAA Regulations can be found here: http://www.faa.gov/regulations_policies/faa_regulations/commercial_space/#guidelines

IATA – INTERNATIONAL AIR TRANSPORT ASSOCIATION

The International Air Transport Association (IATA) publishes the IATA's Dangerous Goods Regulations (DGR) to provide the proper procedures for shippers to safely transport materials with hazardous properties by air on all U.S. commercial air transport. IATA annually publishes the IATA Dangerous Goods Regulations. The IATA requirements contain all of the ICAO Technical Instructions as well as additional restrictive requirements that reflect air transport industry standard practices or operational considerations.

The IATA Dangerous Goods Regulations is considered a "field manual" version of the ICAO Technical Instructions, written and edited by airline dangerous goods experts and is the worldwide standard for air transport. The IATA DGR applies to international shipments as well as all U.S. air transport. By following and conforming to the IATA Dangerous Goods regulations your package will also meet U.S. Department of Transportation requirements for ground transport.

IATA issues revisions and annual updates to the Dangerous Goods Regulations that become effective January 1st of each year. Significant changes in IATA regulations are available approximately six

months prior to the annual January 1 DGR publication. The IATA Dangerous Goods Regulations can be found here: <http://www.iata.org/publications/dgr/Pages/index.aspx>

ICAO - INTERNATIONAL CIVIL AVIATION ORGANIZATION

The United Nations (UN) develops a set of International Transportation of Hazardous Materials Model Regulations through an agency called the International Civil Aviation Organization (ICAO). ICAO develops and publishes a guide called the Technical Instructions for the Safe Transport of Dangerous Goods by Air. Based upon these recommendations, the International Air Transport Association, IATA, develops a set of regulations for the correct packaging and shipping of dangerous goods known as the Dangerous Goods Regulations (DGR). ICAO biannually publishes the Technical Instructions for the Safe Transport of Dangerous Goods by Air, which specifies the procedures for shipping hazardous materials via air transportation and is recognized by DOT in 49 CFR § 171.11.

Additional information about ICAO as well as the Technical Instructions for the Safe Transport of Dangerous Goods by Air can be found here: www.icao.org/.

OSHA – OCCUPATIONAL SAFETY AND HEALTH ASSOCIATION

It is important to note that while the Occupational Safety and Health Association (OSHA) does not regulate infectious substance shipping, they do designate rules and requirements for the proper labeling (e.g., biohazard symbol) and safe handling of infectious substances. OSHA publishes the Bloodborne Pathogens Standard which can be found in Title 29 of the Code of Federal Regulations (CFR) at 29 CFR § 1910.1030. The Bloodborne Pathogens Standard requirements state what employers must do to protect workers who may be occupationally exposed to blood or other potentially infectious material (OPIM), as defined in the standard as a part of their job duties. Current training in the proper safe handling of infectious material is necessary for the training requirements to package and ship infectious substances. The OSHA Bloodborne Pathogens Standard can be found here:

https://www.osha.gov/pls/oshaweb/owadisp.show_document?p_table=standards&p_id=10051

TSA – TRANSPORTATION SECURITY ADMINISTRATION

The U.S. Transportation Security Administration (TSA) was created to strengthen the security of the nation's transportation systems and ensure the freedom of movement for people and commerce. TSA uses a risk-based strategy and works closely with transportation, law enforcement and intelligence communities to set the standard for excellence in transportation security.

Additional information about the TSA can be found here: <http://www.tsa.gov/>.

USPS – UNITED STATES POSTAL SERVICE

The United States Postal Service (USPS) publishes its own set of regulations known as the USPS Domestic Mail Manual (DMM). The USPS DMM provides regulations and requirements for mailing hazardous materials through the U.S. Postal System to align with DOT Hazard Material Regulations

(HMR). The Domestic Mail Manual can be found here:
http://pe.usps.gov/text/dmm300/dmm300_landing.htm.

COMMERCIAL CARRIER AND COURIER SPECIFIC REQUIREMENTS

Commercial carriers such as FedEx, UPS, Airborne Express, World Courier, DHL, etc., are not regulatory agencies, but as carriers they may inspect packages, reject shipments, alert proper regulatory agencies of deficiencies, and develop their own requirements and restrictions in addition to the applicable Federal and International regulations. Be sure to follow any carrier or courier specific requirements and consult with their respective customer support services for assistance.

INSPECTIONS

DOT and FAA both have authority to perform unannounced inspections of facilities that ship dangerous goods or hazardous materials. Inspections of these facilities are to ensure compliance with the current regulations and to perform an on-site inspection of any hazardous material present, and a review of any related procedures. Facilities which do not comply with prescribed regulations are subject to substantial fines. Inspectors visiting your facility may ask to view your packaging and shipping area and supplies, training records, Hazardous Material Security Plans, shipping records and related procedures, infectious waste and other hazardous material supplies or storage that may be present.

TRAINING AND CERTIFICATION

Personnel involved with the packaging or shipping of Division 6.2 material are considered hazmat employees according to DOT and must be properly and currently trained. A hazmat employee is anyone who affects the transport of hazardous materials in commerce. All hazmat employees must be trained and most must be certified. Individuals who may perform duties related to packaging and shipping of Division 6.2 Materials must receive initial training within ninety (90) days of the start of their employment, and then recurrent training in order to stay current and within compliance. Division 6.2 Materials training is the employer's responsibility and must include the following training components:

- General Awareness/Familiarization
- Function-specific
- Safety
- Security Awareness training

NOTE: If a facility possesses Select Agents or other specific quantities or types of listed hazardous material according to DOT, training must also include In-Depth Security training. Additional information about In-Depth Security training and for a list of materials besides select agent that require a facility specific Hazmat Security Plan can be found here:

<http://www.phmsa.dot.gov/staticfiles/PHMSA/DownloadableFiles/Hazmat/Hazmat%20Training/Enhanced%20Security%20Brochure.pdf>

The employer is responsible for identifying which employees need training, and an individual requires training if their employer asks them to do any or all of the following tasks listed below. Because your employer decides what tasks you will be asked to perform, they will ensure you are properly trained to carry out those tasks. You are considered a hazmat employee if your employer asks you to carry out any or all of the following tasks:

- Prepare a shipping paper (e.g. a shipper's declaration form, air waybills)
- Sign a shipper's declaration form
- Classify Division 6.2 materials
- Select packaging for Division 6.2 materials
- Pack hazardous materials for transport
- Label or mark a package that contains hazardous materials
- Transport hazardous materials in commerce
- Provide or maintain emergency response information

Training is required whether you perform one or all of the functions listed above. The frequency of required training as well as the depth of training may vary, depending upon your work assignments. DOT regulations require that individuals who package and ship Division 6.2 materials be certified by their employer. Certification indicates that the employer assures that each certified individual has been trained in a manner that is consistent with the job responsibilities assigned related to packaging and shipping laboratory materials.



REQUIRED TRAININGS

INITIAL TRAINING

A new hazmat employee who changes job functions may perform those functions prior to completion of training, provided the employee performs those functions under the direct supervision of a properly trained and knowledgeable hazmat employee; and the training is completed within 90 days after employment or job function change.

RECURRENT TRAINING

Employees must receive the required refresher training before expiration date, or any time there is a change in job function. IATA requires recurrent training every two years, and DOT, CAP, Joint Commission every three years. Interim training may need to occur due to changes in job responsibilities, changes in regulations, or changes in laboratory needs (i.e. the laboratory obtains select agent registration approval). Since regulations and requirements are updated often, most employers tend to follow the stricter two year recurrent training schedule in order to maintain current awareness. It is important to always follow your facility's internal policy for training frequencies. For additional information, please visit: <http://www.fmcsa.dot.gov/regulations/hazardous-materials/how-comply-federal-hazardous-materials-regulations#sthash.TfG2iPEj.dpuf>

EMPLOYER'S RESPONSIBILITIES

The employer of a facility offering hazardous material for transport is responsible for developing a training policy or program for Hazardous Materials training. The training may be developed and provided in-house, or the employer may choose to seek an externally provided training from a reputable and reliable source to satisfy the training requirements. The training must take into account and cover the following:

- Bloodborne Pathogens
- Hazardous Materials
- General security training
- Conduct facility specific security training (e.g., if the laboratory possesses Select Agents)
- Identify hazmat employees requiring training
- Determine the functions and responsibilities of each employee with regard to hazardous materials
- Train all employees within 90 days of employment
- Provide recurring training as needed
 - Every two years (IATA)²
 - Every 3 years (DOT, Joint Commission and CAP)³

² International Air Transport Association

³ College of American Pathologists

- Change in job responsibilities
- Changes in regulations
- Changes in laboratory needs (e.g. Laboratory seeks to obtain Select Agent approval)
- Test and document employee competence, as needed
- Certify that employee training is consistent with function and responsibilities
- Maintain records of certification

GENERAL AWARENESS AND FAMILIARIZATION TRAINING

General awareness and familiarization training is intended to raise the hazmat employees' awareness of the HMR, DGR, OSHA Bloodborne Pathogens Standard, and any applicable commercial carrier or courier specific requirements, and serve the purpose and meaning of the hazard communication requirements. All hazmat employees must have General Awareness and Familiarization training. Identification and classification of hazardous materials must also be covered. General awareness and familiarization training may be obtained from DOT as a HazMat General Awareness/Familiarization Training CD, or from the CDC at the following links:

- DOT: https://hazmatonline.phmsa.dot.gov/services/Pub_Free.aspx
- CDC: <http://www.cdc.gov/labtraining/>

FUNCTION-SPECIFIC TRAINING

Function specific training is intended to teach the necessary knowledge, skills and abilities for an individual's job function. It is required to include guidance on classification of specimens/isolates, information on how to package, mark, and label them, and instructions regarding documentation and emergency response information of Division 6.2 Materials. The training must also include information regarding regulations of special permits, if applicable. Division 6.2 Materials Function-specific training may be obtained from CDC at the following link: <http://www.cdc.gov/labtraining/>.

Depending on the laboratory area where the employee works and the associated job functions, the individual may require other types of Function-Specific training. This may include "Resource Conservation and Recovery Act (RCRA) Training" for certain environmental laboratorians (<http://www.epa.gov/osw/education/train.htm>), or Global Harmonization Safety Training, with additional information available at: <https://www.osha.gov/dsg/hazcom/global.html>.

SAFETY TRAINING

Safety training needs to provide information concerning the potential hazards posed by materials in the workplace and personal protection measures. The training may include basic emergency response procedures but is not intended to satisfy the requirements of 29 CFR § 1910.120 (Bloodborne Pathogens Standard). Appropriate safety training must include information on how to safely handle Division 6.2 Materials, must include OSHA Bloodborne Pathogen training, and must meet any other applicable employee safety and emergency response training requirements.

“Bloodborne Pathogens Exposure Control for Healthcare Facilities” training may be found at: https://www.osha.gov/dte/edcenters/course_description.html (Course #7200).

SECURITY AWARENESS TRAINING

Each hazmat employee must receive security awareness training. This training must include an awareness of security risks associated with hazardous materials transportation and methods designed to enhance transportation security. New hazmat employees must receive this training within 90 days of employment. This training can be acquired by employer-provided training or by completing the “HazMat Transportation Security Awareness Training Module (HazMat DigiPack 7.2 CD)” located at:

https://hazmatonline.phmsa.dot.gov/services/Pub_Free.aspx

IN-DEPTH SECURITY TRAINING

In addition to the above Security Awareness training, hazmat employees of employers that are required to have a Hazmat Security plan must receive in-depth security training on the facility specific security plan and its implementation. The training must be provided by employers to employees working in entities possessing select agents as well as additionally listed hazardous materials. This training can be developed internally by referencing the following “Enhanced Security Brochure” link below. Additional information about in-depth security requirements including a list of materials other than select agents requiring a facility specific Hazmat Security Plan can be found here:

- <http://www.phmsa.dot.gov/staticfiles/PHMSA/DownloadableFiles/Hazmat/Hazmat%20Training/Enhanced%20Security%20Brochure.pdf>
- Copies of the brochure can be obtained from:
 - https://hazmatonline.phmsa.dot.gov/services/Pub_Free.aspx

TRAINING DOCUMENTATION

A hazmat employer must create and maintain training records for each hazmat employee. Training records must be inclusive of the preceding three years and kept for as long as the hazmat employee is employed and for 90 days thereafter. The training record must include:

- The hazmat employee's name;
- The most recent training completion date of the hazmat employee's training;
- A description, copy or the location of the training materials used to meet the requirements;
- The name and address of the person providing training; and
- Certification that the hazmat employee has been trained and tested as required by this subpart.

The records required to be maintained by the employer must be produced upon reasonable demand by an authorized employee of DOT or FAA. Records may be in any format such as paper or electronic files as long as they contain the required information and are readily available. Compliance with the current requirements for a CDL with a tank vehicle or hazardous materials endorsement provides a driver with the general knowledge and skills necessary to safely operate a commercial motor vehicle with hazardous materials cargo. This may satisfy the hazardous materials training requirements. As a hazmat employee, additional specialized training may be required based on the job function and material-specific requirements related to the handling of hazardous materials. The hazmat employer must determine the extent to which the CDL endorsement satisfies all training requirements.

For additional information, please see: <http://www.fmcsa.dot.gov/regulations/hazardous-materials/how-comply-federal-hazardous-materials-regulations#sthash.TfG2iPEj.dpuf>.

TRAINING RESOURCES

The Centers for Disease Control and Prevention (CDC) in partnership with the National Laboratory Training Network (NLTN) offers a free, online eLearning shipping training course for Division 6.2 Infectious Substances. Participants in the course will first need to have an account with CDC TRAIN. Registration is free and the site is: CDC TRAIN www.cdc.gov/labtraining. Once an account has been setup, locate the course from their catalog and register.

Additionally, the course will inform supervisors or other employers of their responsibilities regarding certification of employees. This course is intended to assist with meeting training requirements and will assist individuals seeking either initial certification or recertification. A series of exercises and case studies will allow participants the opportunity to expand their knowledge of the regulatory requirements, practice applying the regulations as they participate in realistic scenarios and properly document training as a part of the certification process their employers will complete. The course contains numerous job aids which will assist in course completion and be useful as learners are called upon to perform the duties related to this course.

- Locate the course online at: www.cdc.gov/labtraining.

- Follow the link to register for the course in TRAIN.
- Once you have registered, you will receive a detailed confirmation letter by email.
- If you have difficulty with the online registration process, please email labtraining@cdc.gov for assistance.
- For additional program information, please email labtraining@cdc.gov or call (404) 498-6022.
- DOT free publications available here:
https://hazmatonline.phmsa.dot.gov/services/Pub_Free.aspx

The World Health Organization (WHO) also provides a free training and shipping tutorial available here: http://www.who.int/ihr/is_shipping_training/en/

State or Local Public Health Laboratories may provide Packaging and Shipping training regionally in their areas. Always be sure to consult with your State or Local Public Health Laboratories or LRN Reference Laboratory for any offered trainings, or for guidance and questions.



TRANSPORT

CLASSIFICATION

Shipping of all hazardous material or dangerous goods begins with the classification of the substance(s). Classification serves two purposes, first it allows the shipper to select the proper packing instructions (PI) to observe and follow, and second, it provides important information necessary to complete the appropriate documentation, such as a Shipper's Declaration for Dangerous Goods which must accompany all shipments of Category A substances. Shippers must not arbitrarily classify all substances as Category B Biological Substance, or even Exempt Substances to avoid having to make important discriminatory shipping decisions or to make packaging easier or less expensive. Such classification is illegal, is subject to violations, and can be overly expensive. Similarly, classifying all substances as Category A when they may not be would also be inappropriate, and considerably more expensive.

The first step of classification is to determine whether the substance being classified is a *specimen* or *culture*. "**Patient Specimens**" are defined as material collected directly from humans or animals for diagnostic, treatment, prevention, investigational, or research purposes⁴. According to DOT, Patient Specimen includes excreta, secretions, blood and its components, tissue and tissue swabs, body parts, and specimens in transport media (e.g., transwabs, culture media, and blood culture bottles). However, if transport media is incubated prior to transport and demonstrates propagated growth or turbidity, it is no longer considered a patient specimen and would need to be classified as a culture. "**Culture**" is defined as an infectious substance containing a pathogen that is intentionally propagated. The second step of classification is determining whether the substance meets the definition of Category A, Category B, Exempt Specimen, or Non-Regulated. Further details and definitions are found in the specific categories and in the guidance tables below, but in general:

- **Non-Regulated and Exempt Substances:** Not subject to Division 6.2 DOT regulations. Examples include patient specimens from otherwise healthy individuals when shipped by DOT couriers, usually being tested for routine, non-infectious tests. Exempt patient specimen for which there is no, to only a minimal likelihood that pathogens are present when shipped according to IATA and the U.S. Postal Service.
- **Category B, Biological Substances:** An infectious substance not in a form generally capable of causing permanent disability, or life-threatening or fatal disease in otherwise healthy humans or animals when exposure to it occurs. This includes Category B infectious substances transported for diagnostic or investigational purposes.

⁴ International Air Transport Association. 2012. Dangerous Goods Regulations, 53rd ed. Montreal, Canada: International Air Transport Association.

- **Category A, Infectious Substances:** An infectious substance in a form capable of causing permanent disability, or life-threatening or fatal disease in otherwise healthy humans or animals when exposure to it occurs.⁵

The third step of classification is determining who is transporting the material, whether it is an air or ground carrier, or a DOT packaging exception known as Materials of Trade. Each will be described further below.

⁵ International Air Transport Association. 2012. Dangerous Goods Regulations, 53rd ed. Montreal, Canada: International Air Transport Association.

DIAGRAM 1. IATA AND U.S. POSTAL SERVICE CLASSIFICATION FLOWCHART GUIDANCE

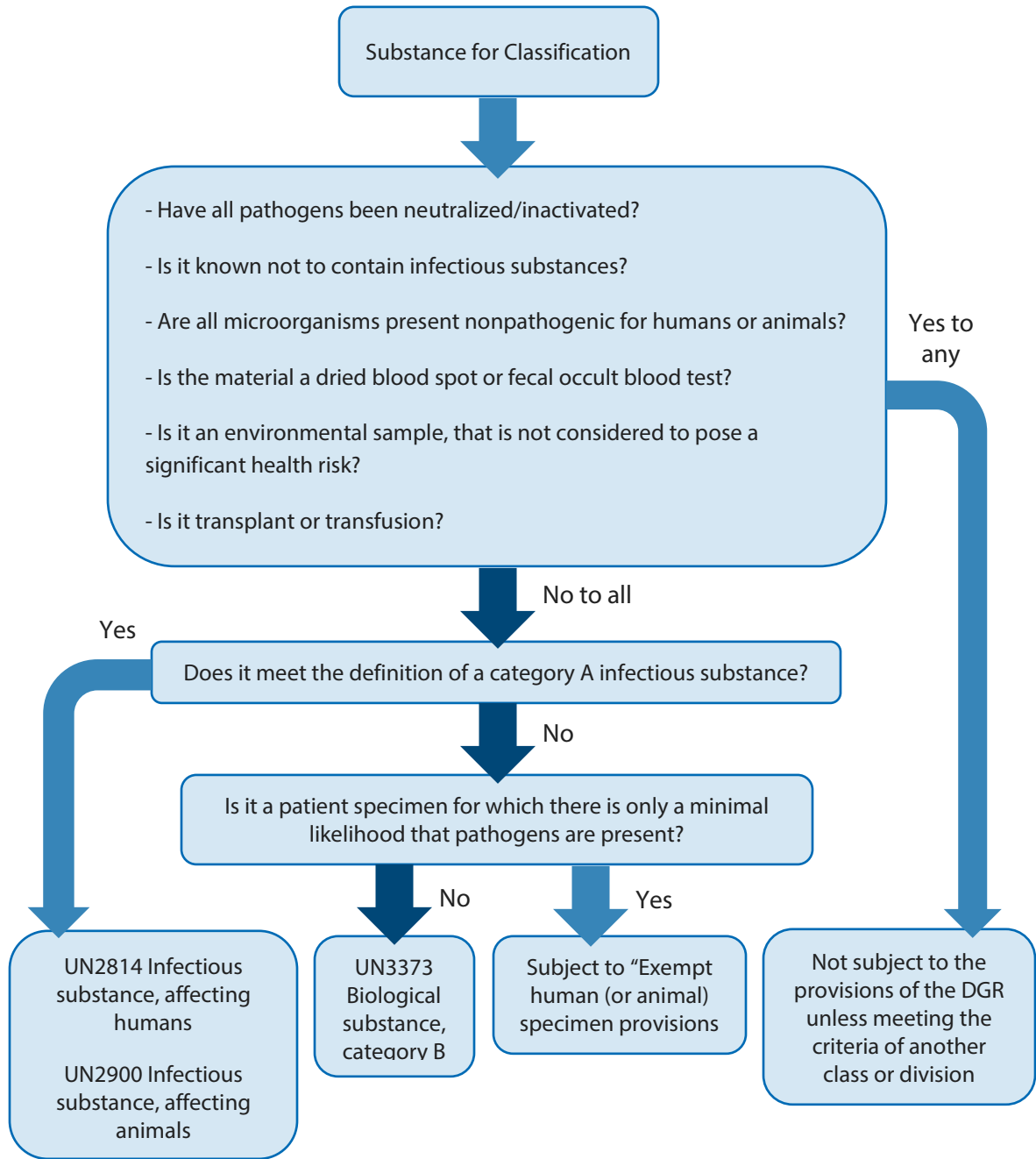
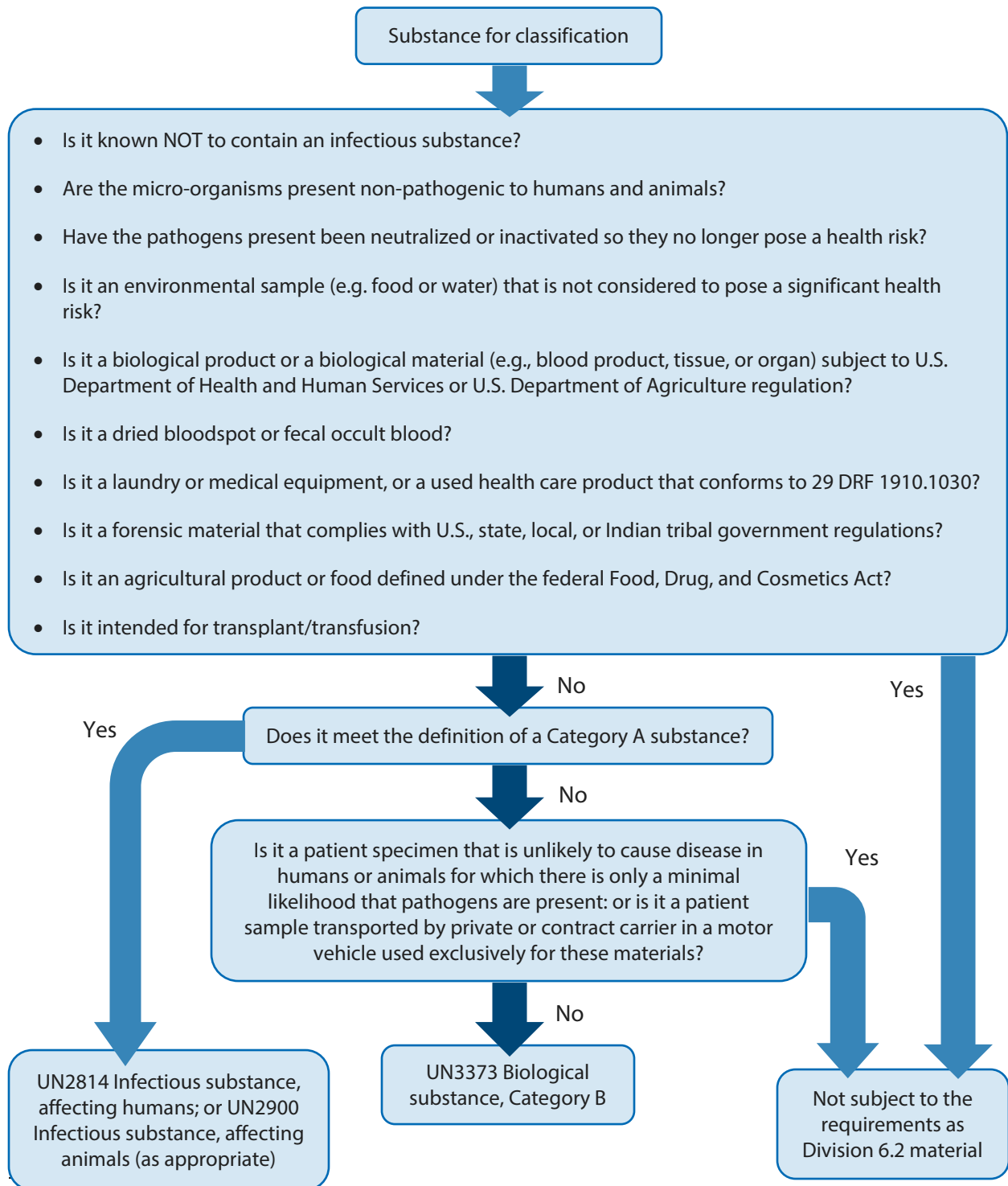

DIAGRAM 2. DOT CLASSIFICATION FLOWCHART GUIDANCE⁶



⁶ DOT Transport of Infectious Substances Safely (DOT PHH50-0079-0706);

https://hazmatonline.phmsa.dot.gov/services/publication_documents/Transporting%20Infectious%20Substances%20Safely.pdf

IATA provides a list of Category A organisms within their annual DGR publication referred to as the *“Indicative Examples of Substances Included in Category A in Any Form Unless Otherwise Indicated Examples List”* found in the DGR as Table 3.6.D. A Category A indicative list has been included within this guidance below as **Table 2**. The list is subject to change, has changed periodically and **not considered to be all inclusive**. Please note that at times, the names of new and emerging pathogens may not always be included and published immediately on regulatory lists. Consult the most recent edition of the IATA Dangerous Goods Regulations that are published annually for updates and revisions.

New and emerging pathogens that may not appear on the current Category A Indicative List but that may possibly meet the same Category A criteria must be assigned to Infectious Substance, Category A, or Suspected Category A. New and emerging pathogens meeting the inclusion Category A criteria, or organisms closely resembling the criteria of microorganisms on this list (e.g., Select Agents), and microorganisms for which there may be a professional doubt concerning pathogenic criteria should also be considered for inclusion and classified as a Category A microorganisms, or a Suspected Category A.

The list of Select Biological Agents and Toxins very closely resembles the Category A list of organisms, although the overlap is not identical. Sample classification for inclusion as a Category A shipment should take into account the organisms on the Health and Human Services (HHS) / U.S. Department of Agriculture (USDA) Select Agent list. Confirmed select agents must always be shipped as Category A, and potential or suspect select agents as “Suspected Category A”. The Select Biological Agent and Toxin list can be found here <http://www.selectagents.gov/SelectAgentsandToxinsList.html>. Always refer to public health authorities (e.g., CDC, WHO, or other state or local public health agencies) for guidance when transporting a new or emerging pathogen or when there is a transporting concern. For additional information about the overlap between the Category A list and the Select Agent list, please view the comparison job aid at the end of this section.



TABLE 2. IATA AND DOT INDICATIVE CATEGORY A LIST

CATEGORY A PATHOGENS INDICATIVE OF INFECTIOUS SUBSTANCES, AFFECTING HUMANS (UN2814) WHEN TRANSPORTED IN ANY FORM UNLESS OTHERWISE INDICATED:

<i>Bacillus anthracis</i> (cultures only)	Japanese encephalitis virus (cultures only)
<i>Brucella abortus</i> , <i>Brucella melitensis</i> , <i>Brucella suis</i> (cultures only)	Junin virus
<i>Burkholderia mallei</i> , <i>Burkholderia pseudomallei</i> (cultures only)	Kyasanur Forest disease virus
<i>Chlamydia psittaci</i> avian strains (cultures only)	Lassa virus
<i>Clostridium botulinum</i> (cultures only)	Machupo virus
<i>Coccidioides immitis</i> (cultures only)	Marburg virus
<i>Coxiella burnetii</i> (cultures only)	Monkeypox virus
Crimean-Congo hemorrhagic fever virus	<i>Mycobacterium tuberculosis</i> (cultures only)
Dengue virus (cultures only)	Nipah virus
Eastern equine encephalitis virus (cultures only)	Omsk hemorrhagic fever virus
Ebola virus	Polio virus (cultures only)
<i>Escherichia coli</i> , verotoxigenic (cultures only)	Rabies virus (cultures only)
Flexal virus	<i>Rickettsia prowazekii</i> , <i>Rickettsia rickettsii</i> (cultures only)
<i>Francisella tularensis</i> (cultures only)	Rift Valley fever virus (cultures only)
Guanarito virus	Russian spring-summer encephalitis virus (cultures only)
Hantaan virus	Sabia virus
Hantavirus causing hemorrhagic fever with renal syndrome	<i>Shigella dysenteriae</i> type 1 (cultures only)
Hendra virus	Tick-borne encephalitis virus (cultures only)
Hepatitis B virus (cultures only)	Variola virus
Herpes B virus (cultures only)	Venezuelan equine encephalitis virus (cultures only)
Highly pathogenic avian influenza virus (cultures only)	West Nile virus (cultures only)
Human immunodeficiency virus (HIV) (cultures only)	Yellow fever virus (cultures only)
	<i>Yersinia pestis</i> (cultures only)

CATEGORY A PATHOGENS INDICATIVE OF INFECTIOUS SUBSTANCES, AFFECTING ANIMALS (UN2900) WHEN TRANSPORTED IN ANY FORM UNLESS OTHERWISE INDICATED:

African swine fever virus (cultures only)
Avian paramyxovirus Type 1-Velogenic Newcastle disease virus (cultures only)
Classical swine fever virus
Foot and mouth disease virus
Goatpox virus
Lumpy skin disease virus
Mycoplasma mycoides – Contagious bovine pleuropneumonia
Peste des petits ruminants virus
Rinderpest virus
Sheep-pox virus
Swine vesicular disease virus
Vesicular stomatitis virus (NOTE: assigned to UN2814 on DOT list)

Note: This is an indicative list and not an all-inclusive list. New and emerging pathogens meeting the inclusion criteria, or organisms closely resembling the criteria of microorganisms on this list (e.g., Select Agents), and microorganisms for which there may be a professional doubt concerning pathogenic criteria should also be considered for inclusion and classified as a Category A microorganisms, or a Suspected Category A. This list is subject to change and has changed periodically. Please note that at times, the names of new and emerging pathogens may not always be included and published immediately on regulatory lists. Shippers should also consult the HHS/USDA Select Biological Agents and Toxins list available at www.selectagents.gov for the shipment of any potential select agent organism or toxin. Confirmed Select Agents must always be shipped as Category A, and potential or suspect Select Agents as “Suspected Category A”. Always refer to public health authorities (e.g., CDC, WHO, or other state or local public health agencies) for guidance when transporting a new or emerging pathogen.

To complete the entire classification process, follow the included classification charts above such as the DOT Transport of Infectious Substances Safely (DOT PHH50-0079-0706)⁷ and the IATA/USPS Guidance Flowcharts in Diagrams 1 and 2. Answer questions within the chart(s) with a “yes” or “no” to aid in your sample classification. Multiple questions grouped together may require all be answered as “yes” or “no”, or may be marked as “yes to any.” Note, the IATA/USPS and the DOT charts are similar except for an additional category labeled “Exempt”, which will be described later in this section.

SUMMARY

To summarize the classification process, the key points are to observe regulation specifics according to mode of transport (air vs. ground); determine if transporting a culture or specimen; consider the use

⁷ DOT Transport of Infectious Substances Safely (DOT PHH50-0079-0706); https://hazmatonline.phmsa.dot.gov/services/publication_documents/Transporting%20Infectious%20Substances%20Safely.pdf

of additional refrigerants or preservatives used to maintain the culture or specimen; and use professional judgment if known medical history and local endemic circumstances plays a role in classifying the substance or supersedes the flowcharts.

Additional requirements, such as the CDC Guidelines for Rapid Toxic Screen, may rule normally exempt specimens as Biological Substances, Category B UN3373. Refer to the CDC Laboratory Response Network for Chemical Terrorism Threat Response (LRN-C)

<http://www.emergency.cdc.gov/lrn/chemical.asp> for additional information before shipping blood or urine from a potentially exposed person.

TRIPLE PACKAGING OVERVIEW

Commercially manufactured shipping containers and materials should be used to contain biological and infectious agents whether sending by private or commercial shipper, U.S. Postal Service, or ground courier. Category A shipping containers are required to meet UN and IATA certification specifications for transport of hazardous materials and be clearly marked. It is important to use the containers as they are received from the manufacturer, follow the included instructions for use and to not mix or match individual components.

After determining the exact nature and category of the substance to be shipped, the shipper must select the most appropriate Packing Instruction (PI) and packing directions to use. See Table 3 for a comparison of the details of packing instructions and directions.



TABLE 3. PACKING REQUIREMENTS FOR EXEMPT HUMAN SPECIMENS, CATEGORY B SUBSTANCES, AND CATEGORY A SUBSTANCES

Packing Requirement	Substance		
	Exempt Human Specimens *	Category B †	Category A ‡
Inner Containers			
leak proof primary (1°) and secondary (2°) containers	yes	yes	yes
pressure-resistant 1° or 2° container	NR §	yes	yes
absorbent between 1° and 2° containers ¶	yes	yes	yes
list of contents between 2° and outer package	NR	yes	yes
positively sealed 1° container	NR	no	yes
Outer Container			
rigid outer packaging	NR	yes	yes
strict manufacturing specifications	none #	few +	many +
name and number of responsible person ↔	NR	yes	yes
markings and labels	yes ∞	less +	more +
Quantity Limits for Either Passenger or Cargo Aircraft			
maximum for each 1° container	NR	1 L / 1 kg	50 mL / 50 g
maximum total for each outer package	NR	4 L / 4 kg	50 mL / 50 g
Documentation			
Shipper's Declaration for Dangerous Goods	NR	no	yes
emergency response telephone number	NR	no	yes
Costs			
cost of labor and materials to pack substance	least +	more +	most +

NR = Not Required

* = packing directions (IATA and DOT provide only minimal standards [i.e., no detailed and numbered packing instructions] for packing and shipping Exempt Human Specimens.)

† = packing instructions 650

‡ = packing instructions 620

§ = requirement not specified by IATA or DOT

¶ = not required for solid substances such as tissue and solid agar media cultures or slants

= should be "of adequate strength for its intended capacity, mass, and intended use" (IATA quote)

+ = See text for details.

↔ = Cat B: may be placed either on the outer package or on the air waybill; Cat A: must be placed on the Outer package

∞ = Only "Exempt Human Specimen" or "Exempt Animal Specimen" is required.

Triple packaging is required for all infectious material including, Category A Infectious Substances, Category B Biological Substances, and applicable for Exempt Human or Exempt Animal Specimens when transported by air⁸. An overview of triple packaging consists of:

INNER PRIMARY CONTAINERS AND MATERIALS

- A primary container must be a leak proof (for liquid material) or sift proof (for solid material) receptacle. Liquids transported by air should have an appropriate air space inside receptacle. Primary containers may be glass, metal or plastic, but must be leak proof and sealed.
- Absorbent material sufficient to absorb all liquid or solid hazardous contents contained within the primary container(s) in case of breakage; must be placed between the primary and secondary containers.

INNER SECONDARY CONTAINERS AND MATERIALS

- A leak or sift proof secondary container which contains the primary container(s) and absorbent material, such as a zip-lock style specimen transport bag containing a biohazard symbol.
- Secondary containers can be rigid or flexible, must be of adequate size to hold the primary receptacle, and contain absorbent material and cushioning (required if multiple or fragile primary receptacles).
- An itemized list of the contents and quantities of the primary container(s) must be attached to or included on the outside of the secondary container and not within. OSHA requires the biohazard symbol to be affixed to primary or secondary receptacles. The itemized list of content requirement may be satisfied with a laboratory sample submission or test request form if the total type and quantity of hazardous material is listed.



OUTER/TERTIARY CONTAINERS AND MATERIALS

- Rigid and durable outer package of adequate strength for its intended use and constructed of cardboard, wood, or material of equivalent strength. If shipping a Category A material, the outer package must bear the UN packaging certification symbol.
- Outer surface must be of adequate size to place all required markings and labels on one side. Labels should measure at least 4" x 4" unless transporting by IATA and package is too small for standard size label. At least one surface must have a minimum dimension of 100 mm by 100 mm (3.9 x 3.9 inches).
- Orientation labels (up arrows) must be placed on opposite sides of all packages which contain >50 mL of a liquid or frozen liquid infectious substance to indicate the correct orientation of the package.

United Nations (UN)
Packaging Certification
Symbol Example



⁸ Packaging Requirements CFR §173.196(b)

- If a Category A substance is shipped, a Shipper's Declaration for Dangerous Goods must also be included on the outside of the package.
- Outer packaging must be marked with the following:
 - Proper Shipping name and UN identification number
 - For Category B Shipments:
 - UN3373 Biological Substance, Category B
 - For Category A, and Suspect Category A Shipments:
 - Category 6 Hazard Label
 - UN2814 Infectious Substance, Affecting Humans (*technical name of organism*)
 - UN2900 Infectious Substance, Affecting Animals (*technical name of organism*)
 - If Suspect Category A, technical name will be listed as "Suspect Category A"
 - **Note:** Special Provision A140 allows the technical name of the organism to be omitted from being displayed on the outer packaging after the proper shipping name; however the technical name of the organism must still be listed after the proper shipping name on the Shipper's Declaration for Dangerous Goods form.
 - Total quantity of included hazardous material
 - Shipper's name, address and contact information
 - Recipient's name, address and contact information
 - Responsible Person's name and contact information
 - **Note:** May be either the shipper or recipient as long as the listed person is knowledgeable of the contents. If listing recipient as the Responsible Person, ensure prior acknowledgement before transport.
 - 24 hour emergency name and contact information
 - **Note:** Must be a live person able to answer a call entire time package is in transport

NOTE: Reuse of manufacturer's packaging is permitted if it is cleaned and disinfected. Do not reuse if the package is damaged, contaminated in any way, or if unable to be labeled and marked properly.

Guidance checklists for Category A, Category B, Dry Ice, Overpack, and Shipper's Declarations are contained at the end of this section and describe the requirements of each shipment type in further detail. Information about obtaining appropriate supplies is also contained further below in the Supplies Section.

The following is an overview of the packaging types for Exempt Specimens, Category B, Category A, and miscellaneous categories.



EXEMPT SPECIMENS⁹

Specimens which have a minimal likelihood that pathogens may be present are classified as “Exempt” if transported by an IATA courier or USPS. IATA requires outer packages to be clearly marked as “Exempt Human Specimen” or “Exempt Animal Specimen” when meeting the classification criteria for exempt specimens. However, DOT does not require this marking on the outer package for shipments meeting these criteria. Exempt specimens can be substances which have been treated by decontamination, neutralization, or inactivation so that the pathogen(s) potentially present no longer poses a health risk and are **not subject to the HMR** unless they meet the criteria for inclusion in another hazard class.

Examples of Exempt Specimens are as follows:

- Blood or urine testing as part of routine medical exam or to monitor levels of:
 - Cholesterol
 - Blood Glucose
 - Hormones
 - Prostate specific antibodies (PSA)
- Blood or urine to monitor liver or kidney functions, as long as they are not known to contain a pathogen
- Tests conducted for insurance or employment, or intended to determine the presence of alcohol or drugs
- DNA Testing
- Specimens for testing other than for the presence of pathogens
 - Biopsies for cancer
 - Antibody titers

⁹ Reference 346.12d



DIAGRAM 3. EXEMPT HUMAN SPECIMEN AND EXEMPT ANIMAL SPECIMEN PACKAGING EXAMPLE

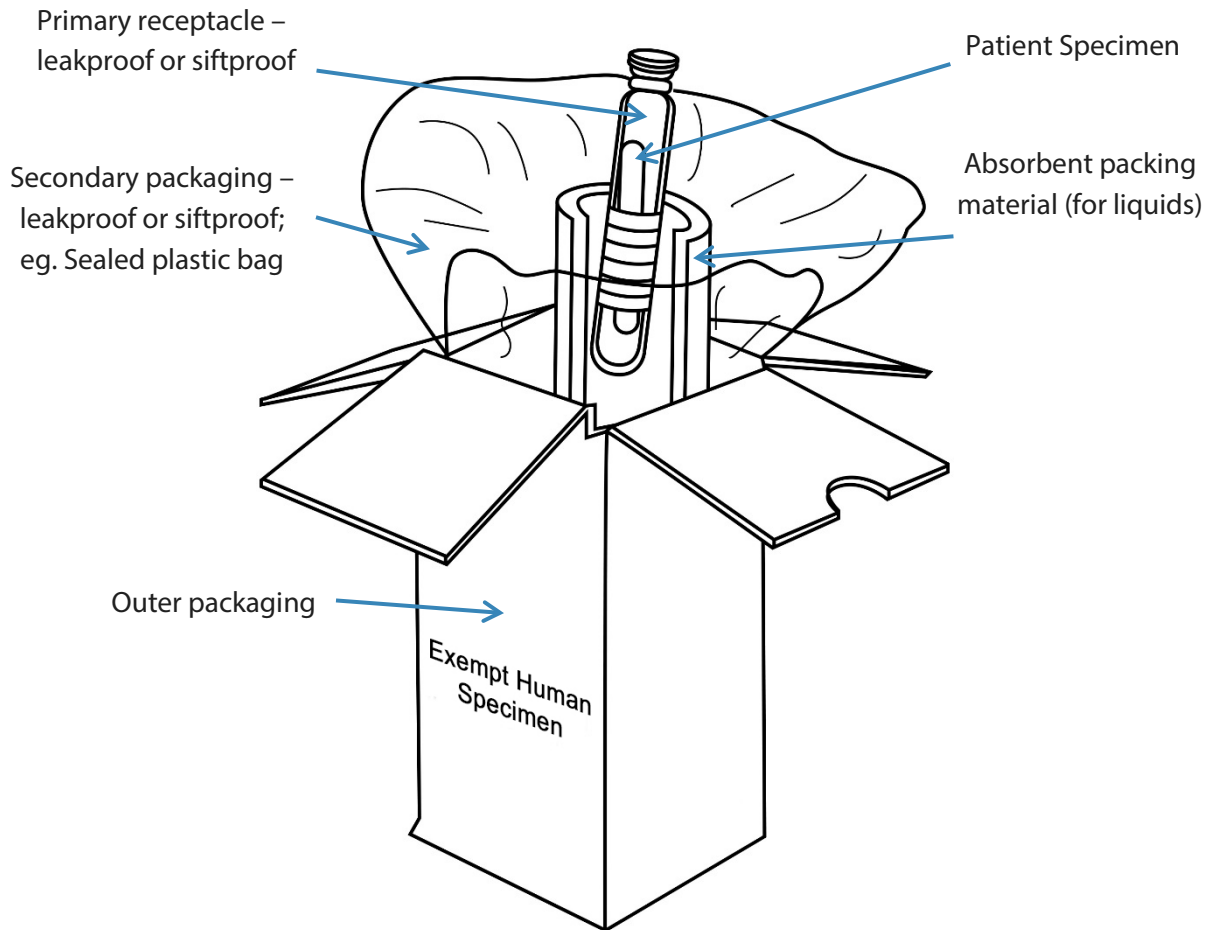
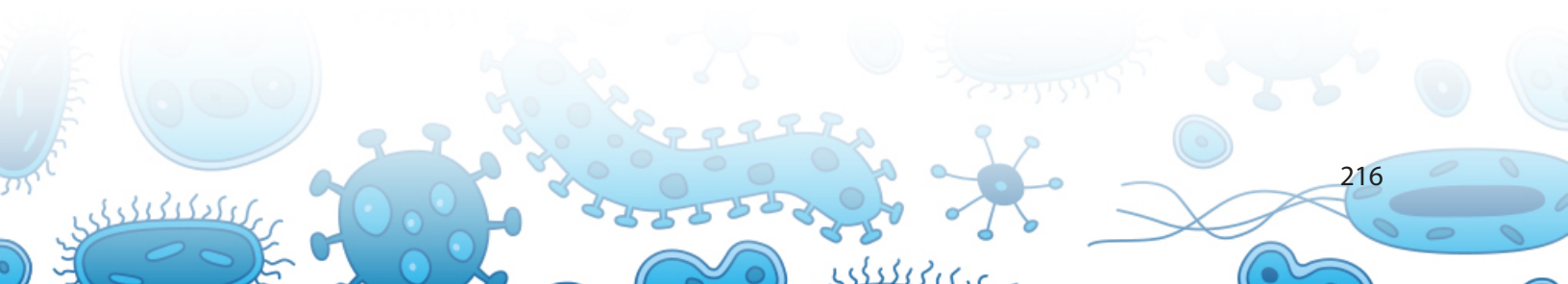

DIAGRAM 4. EXEMPT SPECIMEN OUTER PACKAGE EXAMPLE



DIAGRAM 5. EXEMPT SPECIMEN WITH DRY ICE OUTER PACKAGE EXAMPLE



EXEMPT HUMAN SPECIMEN

Exempt specimens must be triple-packaged in leak proof (for liquids) or sift proof (solids) primary receptacles when shipped by air. Sufficient cushioning and absorbent materials are required around each primary container. Primary and secondary packaging must be enclosed in a rigid outer shipping container (Styrofoam alone is not acceptable). The primary receptacle must not contain more than 500 mL/g. Secondary containers must be marked with the international biohazard symbol and enclosed in a fiberboard box or container of equivalent strength. For air transport, the outer container must be marked on the address side with the words “Exempt Human Specimen” or “Exempt Animal Specimen”. At least one surface must have a minimum dimension of 100 mm by 100 mm (3.9 x 3.9 inches).

CATEGORY B BIOLOGICAL SUBSTANCES

The definition of a Category B Biological Substance is an infectious substance not in a form generally capable of causing permanent disability or life-threatening or fatal disease in otherwise healthy humans or animals when exposure occurs. This group includes Category B infectious substances transported for diagnostic or investigational purposes.

The strict UN specifications and certification symbol marking for the package testing does not apply when shipping Category B substances. Outer boxes used to ship Category B substances need only to be rigid and strong enough for their intended purpose and be certified to pass a 1.2 meter = 3.9 foot drop test.¹⁰ At least one surface must have a minimum dimension of 100 mm by 100 mm (3.9 x 3.9 inches).

The minimum standards for the proper way to prepare, package, and label Category B substances for their safe and proper transport are found in Packaging Instructions (PI) 650. A Category B guidance checklist is contained at the end of this section listing the individual requirements for primary, secondary and outer/tertiary packaging.

¹⁰ International Air Transport Association. 2012. Dangerous Goods Regulations, 53rd ed. Montreal, Canada: International Air Transport Association.

DIAGRAM 7. BIOLOGICAL SUBSTANCE, CATEGORY B PACKAGING EXAMPLE

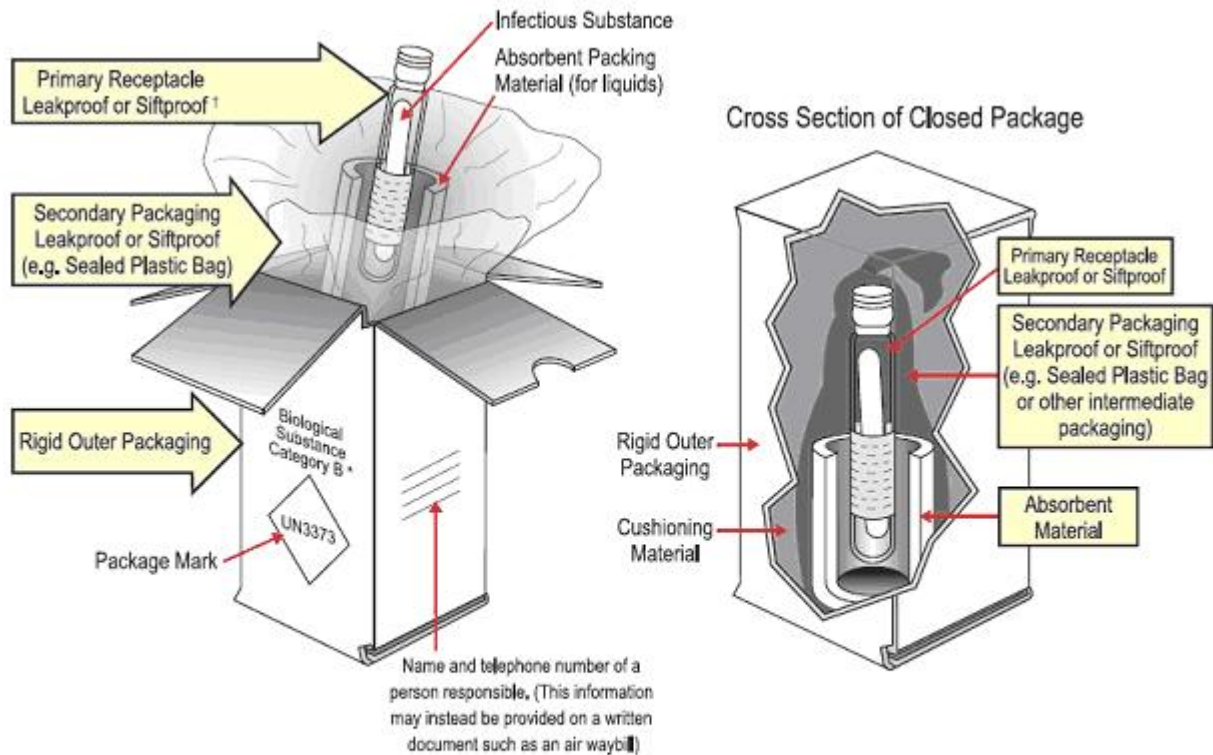

* The proper shipping names "Biological Substance, Category B"; "Clinical Specimen"; and "Diagnostic Specimen" are authorized until December 31, 2006. From January 1, 2007 only the proper shipping name "Biological Substance, Category B" will be authorized.

† If multiple fragile primary receptacles are placed in a single secondary packaging they must be either individually wrapped or separated to prevent contact

Note: Follow package manufacturer's closure instructions

DIAGRAM 8. BIOLOGICAL SUBSTANCE, CATEGORY B LABEL EXAMPLE



**BIOLOGICAL SUBSTANCE
CATEGORY B**

DIAGRAM 9. BIOHAZARD LABEL EXAMPLE FOR INNER SECONDARY CONTAINER



DIAGRAM 10. BIOLOGICAL SUBSTANCE, CATEGORY B WITH DRY ICE OUTER PACKAGE EXAMPLE

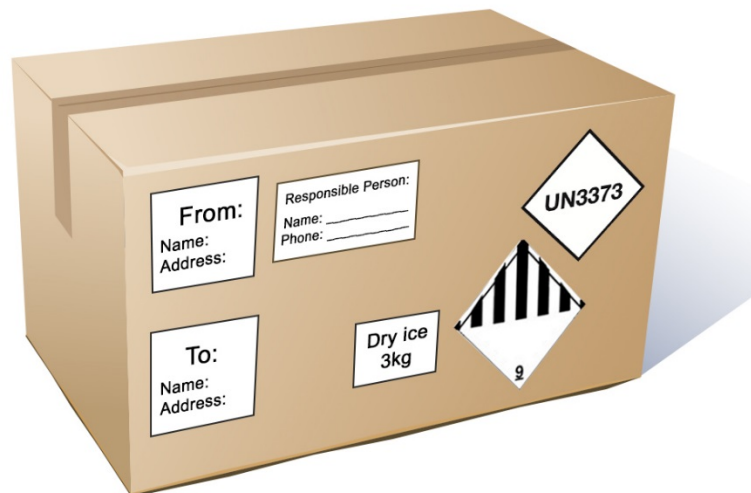

CATEGORY A INFECTIOUS SUBSTANCES

The definition of a Category A infectious substance (pathogen or agent) is an infectious substance which is transported in a form that, if when exposure to it occurs, is capable of causing permanent disability or life-threatening or fatal disease to otherwise healthy humans or animals¹¹. Classification must be based on the known medical history or symptoms of the source patient or animal, endemic local conditions, and professional judgment concerning the individual circumstances of the source human or animal as well as specific and known characteristics of the included infectious material.

¹¹ International Air Transport Association. 2012. Dangerous Goods Regulations, 53rd ed. Montreal, Canada: International Air Transport Association.

If the specimen or material (e.g., culture) meets the definition of a Category A substance, or is on the Category A Indicative List (Table 2), it must be packaged and shipped accordingly. Infectious substances that are considered Category A in “culture” form only are noted in the guidance document [Table 2](#). If there is a potential that a substance may meet the criteria of Category A (e.g., specimen sent following the American Society of Microbiology (ASM) Sentinel Laboratory LRN Rule Out or Refer protocol), it must be classified as Category A Infectious Substance, or “Suspected Category A.”

Category A substances likely to contain a Category A pathogen must be assigned to the UN number(s) **UN2814**, Infectious Substance, Affecting Humans, **UN2900**, Infectious Substance, Affecting Animals, or Suspected Category A (either UN2814 or UN2900). If a Category A pathogen/substance is capable of causing disease in both humans and animals, the pathogen/substance must be classified and shipped as a Category A substance affecting humans, UN2814. Category A pathogens affecting animals ONLY and NOT humans must be classified as UN2900.

The minimum standards for the correct way to prepare, package, and label Category A infectious substances for safe and proper transport are found in Packaging Instructions (PI) 620. Category A packages must display the UN certification marking indicating that the packaging unit has passed specific testing requirements. At least one surface must have a minimum dimension of 100 mm by 100 mm (3.9 x 3.9 inches).

A Category A guidance checklist is contained at the end of this section listing the individual requirements for primary, secondary and outer/tertiary packaging.



DIAGRAM 11. CATEGORY A INFECTIOUS SUBSTANCE OUTER PACKAGING EXAMPLE

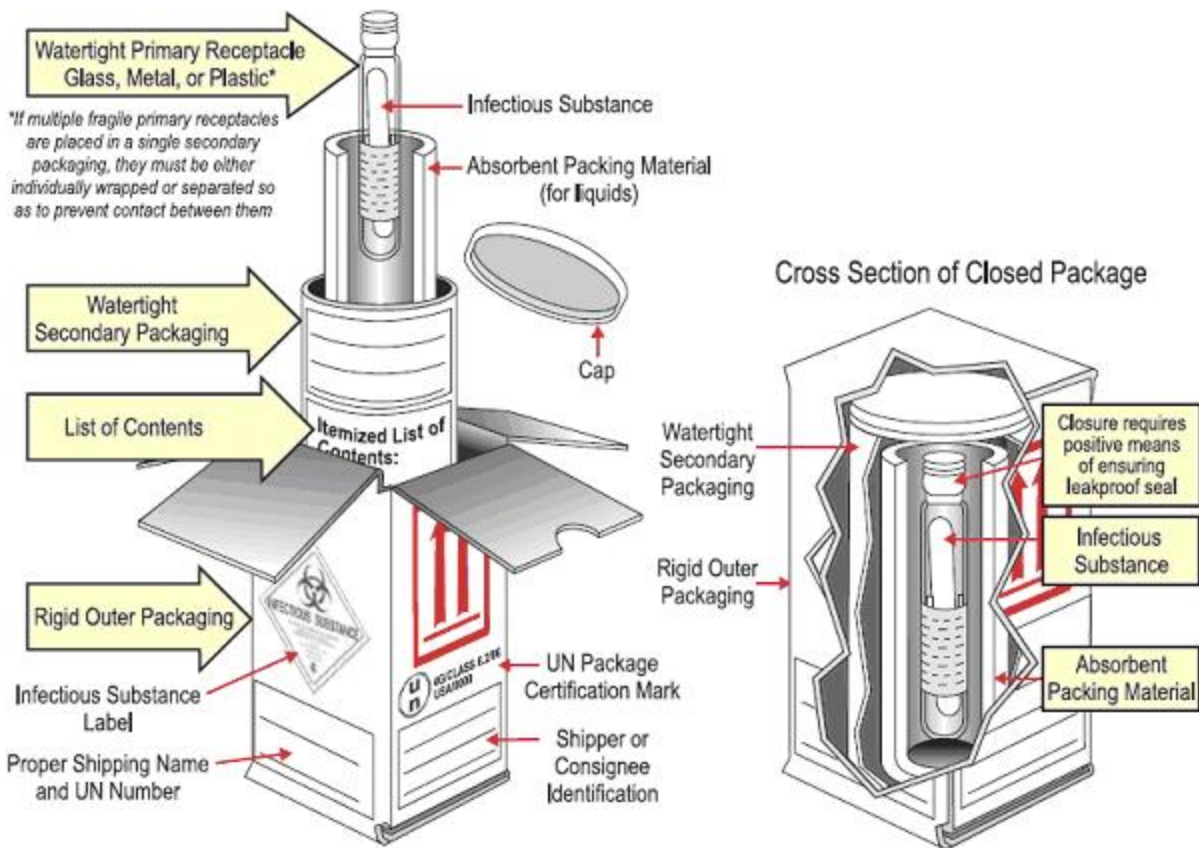

Note 1: The smallest external dimension of the outer packaging must not be less than 100 mm (3.9 inches)

Note 2: The primary receptacle or the secondary packaging must be capable of withstanding without leakage an internal pressure producing a pressure differential of not less than 95 kPa

Note 3: Follow package manufacturer's closure instructions

DIAGRAM 12. CATEGORY A INFECTIOUS SUBSTANCE WITH DRY ICE OUTER PACKAGING EXAMPLE

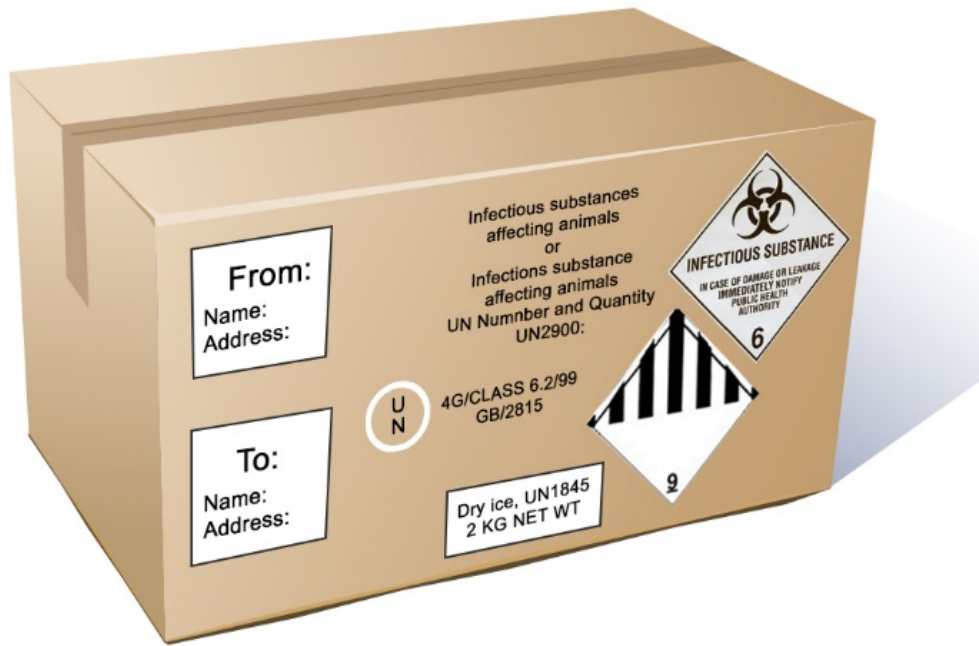

DIAGRAM 13. CATEGORY A, INFECTIOUS SUBSTANCE CLASS 6 HAZARD LABEL EXAMPLE



DIAGRAM 14. CATEGORY A LABEL CHANGE NOTICE

Effective October, 2014, the Category A Hazard Label (pictured) has been revised to omit the emergency response telephone number. The required and updated Category A label will not have a phone number within.

Per the DOT regulations, the Class 6 Infectious Substance label with the text 'In U.S.A. Notify Director-CDC, Atlanta, GA 1-800-232-0124' will no longer be allowed.



Do not use this version of the Class 9 label, effective Oct. 1, 2014.



Use the new version, which has the "In U.S.A. Notify Director-CDC, Atlanta, GA 1-800-232-0124" removed.

DIAGRAM 15. BIOHAZARD LABEL



DIAGRAM 16. UN CERTIFICATION MARKINGS

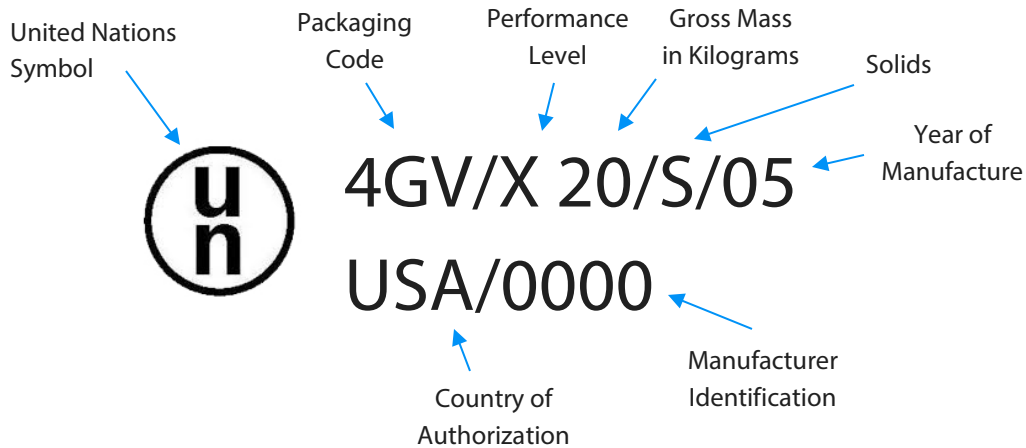

SUSPECT CATEGORY A

When an infectious substance to be shipped is unknown, but suspected or has the potential of meeting the criteria for inclusion in Category A and assignment to either UN2814 or UN2900, the technical name **“Suspected Category A Infectious Substance”** should be used shown in parenthesis, following the proper shipping name on the Shipper’s Declaration. Specific examples when this classification and wording should be used include pathogens that cannot be ruled out after following the American Society for Microbiology (ASM) LRN Sentinel Laboratory guidelines and must be referred to the State or Local LRN Reference Laboratory.

SELECT BIOLOGICAL AGENTS AND TOXINS

Some Category A pathogens or biological toxins have been deemed by the U.S. government to be major threats to the public and designated as potential agents of bioterrorism, or threat agents. These organisms and toxins are known as Select Biological Agents and Toxins and are listed on the National Select Agent Registry website which can be found here: <http://www.selectagents.gov/>.

NOTE: United States federal regulations require shippers to have special permits and registration to possess, use, transfer, and receive these agents¹².

The Federal Select Agent Program has amended the select agent regulations so regulated entities that maintain shipping and receiving facilities in compliance with DOT hazardous substance regulations, and have procedures that are able to maintain select agent and toxin anonymity in shipping/receiving facilities, i.e., preserving "lost in the crowd", will not be required to register these areas even if

¹² Department of Health and Human Services. Possession, use, and transfer of select agents and toxins; 42 CFR Part 73. *Federal Register*. 2008; 73:61363-61366.

packages not identified as containing select agent or toxin will temporarily be stored in these areas. For entities preserving the "lost in the crowd" concept during shipping and receiving, the select agent regulatory oversight for recipients begins when a select agent package arrives at its ultimate destination.

Confirmed select agents must always be sent as Category A, and the designation of "Suspected Category A" may no longer be used. Please note that the organisms on the Select Biological Agent and Toxin list, and the Category A list of organisms are extremely similar, but do not overlap identically, see the [Category A List vs. Select Agent List Comparison job aid](#) at the end of this section for further details.

Always be sure to consult both lists when making the sample classification determination and consult with your Local or State Public Health Laboratory, or LRN Reference Laboratory for guidance.

RISK GROUP 4 (RG4) AGENTS

The World Health Organization (WHO) and the American Biological Safety Association (ABSA) defines Risk Group 4 as a pathogen that is likely to cause serious or lethal human disease for which preventive or therapeutic interventions are not usually available. Therefore, there is a high individual risk and high community risk. RG4 organisms, such as Ebola virus, may have additional restrictions when shipping. Always be sure to consult with the anticipated transporter prior to shipping any potential RG4 material.

MISCELLANEOUS CATEGORIES

Genetically modified organisms and microorganisms (GMO, and GMMO's), biological products, medical waste, and infected animals each require proper shipping names, UN identification codes, and have defined regulations beyond the scope of this guidance document. Refer to the DOT guidelines for these classifications and for further information.

REFRIGERANTS AND PRESERVATIVES

Refrigerants and preservatives are commonly utilized and included when shipping Division 6.2 materials. Refrigerants such as frozen or wet ice (e.g., frozen gel packs), and dry ice are routinely included to maintain specimen temperature and integrity during transport. If frozen, wet ice, or dry ice is used, the shipper needs to ensure to include sufficient absorbent material to absorb any extra moisture that may result from melting or sublimation (for dry ice) during transport. Adding sufficient absorbent material around the refrigerant will also help ensure the integrity of the cushioning or the packaging container structure in the event of excess moisture. Shippers should always keep in mind that refrigerants are used to *maintain* an internal temperature during transport, and not to bring the sample/material to the desired temperature during transport. Therefore, shippers should always have the samples/material maintained at the needed temperature prior to placement in the shipping container and the addition of refrigerant material.

If a shipment contains dry ice, the outer package needs to be marked as such. The appropriate external labeling for dry ice is:

- Class 9 miscellaneous hazard label
- UN1845 hazard identification label
- Quantity of included dry ice (i.e., 4.5kg)

If dry ice is included with a Category A shipment, the dry ice must be listed on the required Shipper's Declaration for Dangerous Goods form. If dry ice is included in a Category B shipment, an Exempt Specimen shipment, or shipped alone, it will only need to be marked on the outside of the package as described above. Since a Shipper's Declaration for Dangerous Goods form is not required for Category B shipments, Exempt Specimen shipments, or when dry ice is shipped on its own, dry ice would not need to be listed on the Shipper's Declaration form that would not need to accompany those shipments. A dry ice guidance checklist is contained at the end of this section for assistance.

DIAGRAM 17. DRY ICE LABEL CHANGE NOTICE

Effective October, 2014, the Category A Hazard Label (pictured) has been revised to omit the emergency response telephone number. The required and updated Category A label will not have a phone number within.

Effective October 1, 2014

Per DOT regulations, Class 9 hazard labels with the horizontal line will no longer be accepted.

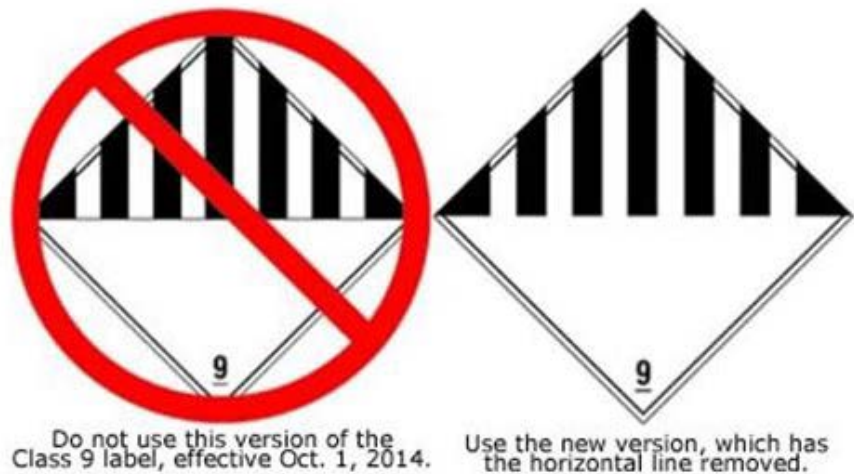

DIAGRAM 18. DRY ICE LABEL EXAMPLE

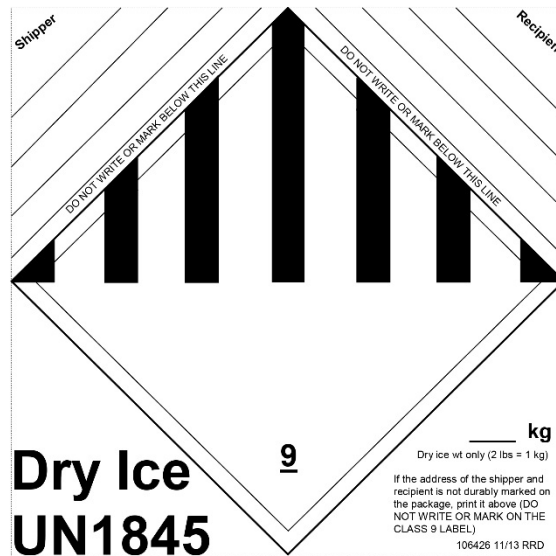

DIAGRAM 19. OVERPACK LABEL EXAMPLE



FORMALIN, FORMALDEHYDE, ETHANOL AND METHANOL

Alcohols such as ethanol or methanol are commonly added as a preservative or stabilizer in many laboratory samples (i.e., parasitology specimens, cancer biopsies, etc.) and may be ingredients if formaldehyde or formalin is used. These types of samples may contain regulated Class 3 Flammable Solutions or Class 9 Miscellaneous Hazards depending on the concentrations and mixtures.

Formalin is specifically defined as a 37% aqueous solution of formaldehyde. A 10% formalin solution and a 10% formaldehyde solution are NOT the same materials for transport purposes. 25% Formalin solutions have approximately 10% Formaldehyde and would be classified as "UN3334, Aviation regulated liquid, n.o.s. (formaldehyde), Class 9" for transportation by air.

There are four different classification options for formaldehyde solutions:

1. If more than 25% of the solution is formaldehyde, it is assigned to UN 2209 *Formaldehyde solution*
2. If there is 10% to 25% formaldehyde in the solution, it is assigned to UN 3334 *Aviation regulated liquid, n.o.s., Class 9*
3. If there is less than 10% formaldehyde in the solution and the solution also contains an alcohol, it is assigned to UN 1198 *Formaldehyde solution, flammable*
4. If there is less than 10% formaldehyde in the solution and there is no alcohol in the solution, the transport regulations do not consider it a dangerous good and therefore it is not subject to the regulations

Formaldehyde solutions of less than 10% are not considered hazardous materials; concentrations above this amount are subject to specific requirements not covered at length in this guidance. There are no quantity limits for shipment of solutions of less than 10% formaldehyde. The Hazardous Material Table in 49 CFR § 172.101 provides two entries for formaldehyde:

1. Formaldehyde solutions, flammable, UN1198;
2. and Formaldehyde solutions, with not less than 25% Formaldehyde, UN2209

These entries imply that formaldehyde solutions, which are not flammable or have less than 25% formaldehyde, are not regulated, but 10-24.9% require regulation as a Hazard Class 9 material when shipped by air. Shipments of 10-24.9% formaldehyde solutions shipped by highway only do not require classification as a hazardous material. 10% Formalin solutions contain 3-4% Formaldehyde and are **not** regulated for transport by air or highway. "Formaldehyde solutions, flammable, UN1198" is intended for use as a hazardous materials description for formalin. Formaldehyde solutions are generally assigned to UN 2209 under the classification "Dangerous Goods, Class 8." The only solutions required to be shipped according to the requirements of UN 2209 are those which contain more than 25% formaldehyde. When the percentage of formaldehyde in the solution is below 10%, there are two classification options. The difference between these options depends on the presence of alcohol in the solution

1. If there is no alcohol in the less than 10% formaldehyde solution, it is not considered dangerous and therefore is not subject to the transport regulations.
2. However, many solutions with less than 10% formaldehyde use an alcohol to stabilize the mixture. Some common alcohols used in these solutions are methyl alcohol or methanol. Any quantity of alcohol changes the classification of the solution.

The classification of a solution with less than 10% formaldehyde and with any quantity of an alcohol is a Class 3 Flammable Liquid with a Class 8 Corrosive subsidiary risk, and is assigned to UN 1198 with the proper shipping name *Formaldehyde solution, flammable*. A formaldehyde solution, with less than 25% but not less than 10% formaldehyde is a Class 9 material. Tissues and specimens being shipped in formalin solutions are not considered to be Diagnostic Specimens or infectious substances unless there is a high probability that an infectious substance is present.

There are regulatory exemptions for some Division 6.2 material with preservatives that should be consulted for applicability:

1. 49 CFR § 173.4, Small quantities for highway and rail
2. 49 CFR § 173.4a, Excepted Quantities
3. 49 CFR § 173.4b, De Minimis Exception
4. 49 CFR § 173.6 Materials of Trade

If there are any questions or concerns regarding the composition, always refer to the package insert, or to the Safety Data Sheet (SDS) for consultation.

MATERIALS OF TRADE

Certain hazardous materials transported in small quantities as part of a business are subject to less regulation, because of the limited hazard they pose. These materials are known as Materials of Trade (MOT) according to DOT. The MOT classification applies only to patient specimens that are classified as category B, and do NOT apply to any culture with propagated growth. Category A specimen(s) or culture(s) cannot be shipped using the Materials of Trade classification.

Materials of Trade means a hazardous material, other than a hazardous waste, that is carried on a motor vehicle; (1) For the purpose of protecting the health and safety of the motor vehicle operator or passengers; (2) For the purpose of supporting the operation of a motor vehicle (including its auxiliary equipment) or; (3) By a private motor carrier (including vehicles operated by a rail carrier) in direct support of a principal business other than transportation by a motor vehicle.

In order to ship a sample as MOT, the inner packaging (primary container) must be leak proof for liquids, sift proof for solids and securely closed, secured against shifting and protected against damage. Outer packaging must be strong and include labeling for either the proper shipping name or the common name (i.e., blood, human or clinical specimen). Affix the biohazard label either on inner or outer packaging.

Materials of trade can only be transported by motor vehicle, as long as the business is not transportation, such as taxi service, bus or contracted couriers. An example of the correct courier might be a lab-employed courier.

Please be aware that it is the responsibility of the shipper to know if the material being transported applies to the HMR requirements. The regulations that apply to MOTs are found in 49 CFR § 173.6 and they include:

- General knowledge of MOTs regulations;
- Quantity limitations;
- Packaging requirements; and
- Marking and labeling requirements.

The MOTs regulations do not require:

- Shipping papers;
- Emergency response information;
- Placarding; or
- Formal training or retention of training records.

The transportation of Materials of Trade items (see 49 CFR § 171.8) by highway may be excepted from many of the requirements of the Hazardous Materials Regulations when transported in accordance with the procedures contained in 49 CFR § 173.6. See more at:

<http://www.fmcsa.dot.gov/regulations/hazardous-materials/how-comply-federal-hazardous-materials-regulations#sthash.TfG2iPEj.dpuf>

SHIPPER'S DECLARATION FOR DANGEROUS GOODS OVERVIEW

A Shipper's Declaration for Dangerous Goods form is required for both air and ground transport of all Category A infectious substances. It is a legal contract between the shipper and carrier, and is required to document the shipment of Category A infectious substances. The form must be accurate, legible, completed and signed. If any of these conditions are not met, even to the slightest degree, the carrier has the right to reject and return the package for transport, and the shipper may be subject to fines or other violations.

Certain carriers (e.g., FedEx) require the Shipper's Declaration to be prepared by using FedEx proprietary online software or software they approve; some require the information to be completed online; and some require multiple copies be submitted. The original Shipper's Declarations given to the carrier must have slanted red candy stripes along the left and right edges of the document. Checklists can also be found on the IATA or carrier websites to use as another method to assess completed forms. Shippers must retain copies of Shipper's Declarations for at least two years and at least three years for any shipments involving select agents.

If dry ice is used as a refrigerant within a Category A shipment, the dry ice must be listed on the included Dangerous Goods Shipper's Declaration form as a Class 9 Miscellaneous Dangerous Good. If dry ice is included within a Category B shipment, a Dangerous Goods Shipper's Declaration form is not necessary to accompany the shipment, and therefore dry ice would not need to be listed on the form that is not required. However, packages containing dry ice must still be packaged according to Packing Instruction (PI) 954, and displaying the appropriate miscellaneous hazard labels whenever included.

DIAGRAM 20. FEDEX SHIPPER'S DECLARATION FOR DANGEROUS GOODS FORM EXAMPLE

SHIPPER'S DECLARATION FOR DANGEROUS GOODS		(Provide at least three copies to the airline.)			
Shipper		Air Waybill No.			
		Page of Pages			
		Shipper's Reference Number			
Consignee		This shipper's declaration was prepared using a FedEx Express template. It must be used ONLY for:			
		* Class 7 radioactive shipments			
		* Shipments using an 023 air waybill (IP1, IXF or ATA service)			
		* Shipments originating from a non-US location			
Two completed and signed copies of this Declaration must be handed to the operator		WARNING			
TRANSPORT DETAILS This shipment is within the limitations prescribed for: (delete non applicable)		Failure to comply with all respects with the applicable Dangerous Goods Regulations may be in breach of the applicable law, subject to legal penalties.			
<table border="1"> <tr> <td>PASSENGER AND CARGO AIRCRAFT</td> <td>CARGO AIRCRAFT ONLY</td> </tr> </table>		PASSENGER AND CARGO AIRCRAFT	CARGO AIRCRAFT ONLY	Airport of Departure	
PASSENGER AND CARGO AIRCRAFT	CARGO AIRCRAFT ONLY				
Airport of Destination:		Shipment type: (delete non-applicable) <input type="checkbox"/> NON-RADIOACTIVE <input type="checkbox"/> RADIOACTIVE			
NATURE AND QUANTITY OF DANGEROUS GOODS <i>UN Number or Identification Number, proper shipping name, Class or Division (subsidiary risk), packing group (if required), and all other required information.</i>					
Additional Handling Information					
I hereby declare that the contents of this consignment are fully and accurately described above by the proper shipping name, and are classified, packaged, marked and labelled/placarded, and are in all respects in proper condition for transport according to applicable International and National Governmental Regulations. I declare that all of the applicable air transport requirements have been met.		Name/Title of Signatory			
		Place and Date			
		Signature (see warning above)			
Emergency Telephone Number		Jane Smit			
FOR RADIOACTIVE MATERIAL SHIPMENT ACCEPTABLE FOR PASSENGER AIRCRAFT, THE SHIPMENT CONTAINS RADIOACTIVE MATERIAL INTENDED FOR USE IN OR INCIDENT TO RESEARCH, MEDICAL DIAGNOSIS, OR TREATMENT. ADR EUROPEAN TRANSPORT STATEMENT: CARRIAGE IN ACCORDANCE WITH 1.1.4.2.1					

IATA SHIPPER'S DANGEROUS GOODS DECLARATION FORM (FOR ALL AIR TRANSPORT):

- Specific form with slanted red hatching (candy stripes) along left and right edges of document.
- FedEx requires use of compliance checking software such as FedEx Ship Manager™ Software or FedEx approved software when generating a shipper's declaration to accompany a shipment they will carry.
- Consult and use available checklists on IATA or carrier websites to check package for accuracy.
- Specific items to be listed on the Shipper's Declaration for Dangerous Goods form include:
 - Shipper's name and contact information
 - Recipients name and contact information
 - Airway bill number
 - Designation of whether the package can be transported as Passenger and Cargo, or Cargo only by Aircraft
 - Designation of radioactive vs. non-radioactive contents
 - UN identification number (e.g., UN2814)
 - Proper Shipping Name of material [e.g., Infectious Substance, Affecting Humans (*technical name of the organism*)]
 - Class or Division (Subsidiary Risk) (e.g., 6.2)
 - Packing Group (if applicable)
 - Quantity and type of packaging used (e.g., one fiberboard box)
 - Packing Instruction (e.g., PI 620)
 - Authorization (e.g., A81, A140)
 - Emergency Response contact information
 - Title and signature
- Emergency Response Information (ERI), include area code and must be answered by person listed and must be answered entire time package is in transit. If third party provider used, enter phone number with area code, and contractor name as appears on contract, or list contract number.
- IATA requires individual name for responsible person, not a title or company name.
- Provide 3 signed copies all printed in color or two in color, one in black & white to FedEx courier.
 - Shippers must retain copies of Shipper's Declarations for at least two years, and if any select agent is shipped, records must be kept for a minimum of three years.

COMMON PACKAGING, LABELING AND MARKING ERRORS INCLUDE:

- Technical name of organism as listed on indicative Category A list (Table 2), listed incorrectly. Do not abbreviate or misspell technical names of organisms.
- Incorrect packaging description such as "Styrofoam" or "cardboard box". Do not use acronym only.
- Quantity of hazardous material listed incorrectly.

DOT SHIPPER'S DANGEROUS GOODS DECLARATION FORM:

Motor vehicle (ground) transport does require a shipper's declaration, but DOT does not use a specific type of form, or require it to be in color. Commercial ground transport companies may provide their own declaration or one can be created in column form. Certain basic description information of the hazardous contents must be included in a specific order:

- UN identification number (e.g., UN2814)
- Proper shipping name [e.g., Infectious Substance, Affecting Humans (*technical name of the organism*)]
- Hazard Class or Division (e.g., 6.2)
- Packing Group if necessary
- Number and type of packaging (e.g., one fiberboard box)
- Total quantity of hazardous contents by weight or volume (e.g., 5mL)
- 24 hour Emergency Response contact information
- Responsible Person contact information
- Shipper's certification statement is required if courier is not an employee of shipper
 - Must be signed by shipper
 - Additional forms to be included with DOT's Shipper's Declaration include written emergency information such as Guide 158 or SDS sheet for specific pathogen included.

CATEGORY A, PROPER SHIPPING NAME EXAMPLES

Below are a few common Category A examples that may be encountered in the laboratory:

- Shiga toxin producing *E. coli* O157:H7 (Verotoxigenic)
 - UN2814, Infectious Substance, Affecting Humans (*Escherichia coli* O157:H7)
 - Or, UN2814, Infectious Substance, Affecting Humans (*Escherichia coli* verotoxigenic)
- *Mycobacterium tuberculosis* (TB)
 - UN2814, Infectious Substance, Affecting Humans (*Mycobacterium tuberculosis*)
- Suspected Anthrax
 - UN2814, Infectious Substance, Affecting Humans (*Bacillus anthracis*)
 - Or, UN2814, Infectious Substance, Affecting Humans (Suspected Category A Infectious Substance)

Each of these above examples would be associated with Division 6.2, and not have Packing Group associated. Ensure the amount of hazardous material being shipped is also listed as well as the type of outer container material.

Note: Special Provision A140 permits the technical name of the organism from being omitted from the outer package labeling, however, the technical name of the organism must still be listed on the Shipper's Declaration for Dangerous Goods form.

COURIERS

Safe ground transportation of specimens to and from laboratories is governed by regulation issued by the Department of Transportation (DOT) and the U.S. Postal Service (USPS). Shippers MUST be aware of what types of packages the carrier or courier accepts or what is restricted (variations), what liability the courier company possesses and have written agreement before utilizing their services. Courier credentials can be found at <http://safer.fmcsa.dot.gov/CompanySnapshot.aspx>.

Couriers need to have a driver's license appropriate for their job (CDL for commercial couriers) and have a clean driving record. Good knowledge of medical terminology and basic medical procedures is helpful. Couriers must be trained in function-specific tasks, safety and security awareness, and be familiar with regulations. Finally, couriers are responsible for knowing what their emergency response obligation is if there is an incident involving packages being transported.

PRIVATE COURIERS

A private motor carrier transports its own cargo, usually as a part of a business. Therefore, the courier is hired by and on the company payroll. Private couriers may not be subject to the requirements of Division 6.2 if the private vehicle is used only to transport patient specimens or cultures (not Category A), and other medically-related items such as diagnostic test kits or medical documents. Each item must still be appropriately packaged and be protected from exposure. Couriers CANNOT transport other patients, other persons including employees or non-medically related items. See Materials of Trade section for additional and related information.

COMMERCIAL COURIERS

Motor carriers must have specific insurance and legal process agent documents on file with the Federal Motor Carrier Safety Administration (FMCSA). The required filings vary, based on the product being carried. Most important, the courier who accepts package(s), MUST recognize what is offered to them as UN3373 Category B Biological Substances, UN2814 Infectious Substances or specimens not regulated by DOT (Exempt); and if the courier company has the authority to accept. They must also recognize if the package is correctly marked and has proper documentation offered with the package.

GOVERNMENT COURIERS

During public health emergencies, law enforcement agents or other designated state officials with identification may deliver specimens exempt from the HMR, as found in the 49 CFR § 171.1 d(5-6):

- Applicability of Hazardous Materials Regulations (HMR) to persons and functions. Functions are not subject to the requirements of the HMR. The following are examples of activities to which the HMR do not apply:
 - Transportation of a hazardous material in a motor vehicle, aircraft, or vessel operated by a Federal, state, or local government employee solely for noncommercial Federal, state, or local government purposes.
 - Transportation of a hazardous material by an individual for non-commercial purposes in a private motor vehicle, including a leased or rented motor vehicle.

- Under these circumstances, laboratories may be exempt from following all of the official shipping regulations if these criteria are met. Permission for exemption must be granted by state officials. Packaging regulations and instructions however should always be followed for safety considerations.

EXCLUSIVE MOTOR VEHICLE EXCEPTION

The exclusive motor vehicle exception found in 49 CFR § 173.134 (b)(10) may apply to a Division 6.2 material, other than a Category A infectious substance, contained in a patient sample being transported for research, diagnosis, investigational activities, or disease treatment or prevention, or a biological product, when such materials are transported by a private or contract carrier in a motor vehicle used exclusively to transport such materials. Medical or clinical equipment and laboratory products may be transported aboard the same vehicle provided they are properly packaged and secured against exposure or contamination. If the human or animal sample or biological product meets the definition of regulated medical waste, it must be offered for transportation and transported in conformance with the appropriate requirements for regulated medical waste. An example of the Exclusive Motor Vehicle Exception in public health practice may be when a suspected outbreak patient drives their own stool sample to a health department.

Always consult with local or state health departments if there are any questions or concerns.

EMERGENCY RESPONSE INFORMATION AND INCIDENT RESPONSE

The requirements for Emergency Response information is contained in 49 CFR § 172, Subpart G. Emergency Response Information (ERI) must accompany Category A packages and be provided by the shipper to the courier when transported by air or motor vehicle. A Responsible Person's contact information and 24 Hour Emergency Contact information must be marked on the outside of the package, as well as appearing on the Shipper's Declaration form.

The Responsible Person can be either the shipper or the recipient. The Responsible Person needs to be knowledgeable about the material being shipped and has comprehensive emergency response incident mitigation information, or information of someone who has immediate access to that information. The 24 Hour Emergency Contact information must be someone who is available the entire time the material is in transit, knowledgeable of the material being transported, and has comprehensive emergency response mitigation information for the material. The 24 Hour Emergency contact must be a live person capable of providing information about the included material. It must be maintained at all times that a shipment is in transit. The use of beepers, answering machines and switchboards is not authorized. The phone number must be to someone capable of providing information on the material.

Written emergency response information must be appropriate for the hazardous material being transported. If the carrier's equipment has an emergency response guide or similar document on board there is no requirement to provide a separate emergency response document. For transportation by highway, if a transport vehicle contains hazardous materials for which a shipping paper is required and the transport vehicle is separated from its motive power and parked at a

location other than a facility operated by the consignee, consignor, or carrier, the carrier shall (1) Mark the transport vehicle with the telephone number of the motor carrier on the front exterior near the brake hose or electrical connection; or (2) have the shipping paper and emergency response information readily available on the transport vehicle. This requirement does not apply if the identification number for each hazardous materials contained therein is marked on the outside of the vehicle on an orange panel or white square on point placard.

References intended to be used in conjunction with ERI that provide safety resources and information for laboratory personnel who work with and ship Division 6.2 infectious substances can be found at:

1. Emergency Response Guide (ERG) 2012, Guide 158: <http://phmsa.dot.gov/hazmat/library/erg>
2. Pathogen Safety Data Sheets (PSDS), accessible from the Public Health Agency of Canada website: <http://www.phac-aspc.gc.ca/lab-bio/res/psds-ftss/index-eng.php>.

INCIDENT REPORTING

The release of infectious substances (Category A or B) during any mode of transportation must be reported to the Department of Transportation according to the incident reporting requirements listed in 49 CFR §171.15 and §171.16. Immediate notification of a hazardous materials incident by a carrier is required at the earliest practical moment for incidents that occur during the course of transportation (including loading, unloading, and temporary storage) in which as a direct result of the hazardous materials any one or more of the following occurs:

1. A person is killed;
2. A person receives an injury requiring admittance to a hospital;
3. The general public is evacuated for one hour or more;
4. A major transportation artery or facility is closed or shut down for one hour or more; or
5. Fire, breakage, spillage, or suspected radioactive contamination occurs involving a radioactive material;
6. Fire, breakage, spillage, or suspected contamination occurs involving an infectious substance other than a diagnostic specimen or regulated medical waste;
7. A release of a marine pollutant occurs in a quantity exceeding 450L (119 gallons) for a liquid or 400 kg (882 pounds) for a solid; or
8. A situation exists of such a nature (e.g., a continuing danger to life exists at the scene of the incident) that, in the judgment of the person in possession of the hazardous material, it should be reported to the National Response Center even though it does not meet the other criteria.

Each notice shall be given telephonically to the DOT at (800) 424-8802. Incidents involving etiologic agents may be made to the CDC at (800) 232-0124. For content of report and additional information, please see § 171.15.

A written report shall be submitted on DOT Form F 5800.1 for all incidents involving the transportation of hazardous materials unless excepted. Detailed reporting requirements are contained in § 171.16.

For additional reporting information, please visit: <http://www.fmcsa.dot.gov/regulations/hazardous-materials/how-comply-federal-hazardous-materials-regulations>.

TRANSFERS AND PERMITS

The CDC provides general information about permit requirements here: <http://www.cdc.gov/od/eaipp/>.

The United States Department of Agriculture (USDA), Animal and Plant Health Inspection Service (APHIS) permits are required for transport of infectious agents of livestock and biological materials containing animal material. Animal and animal products includes live animals, semen, embryos and materials derived from animals or exposed to animal-source materials such as animal tissues, blood, cells or cell lines of livestock or poultry origin, RNA/DNA extracts, hormones, enzymes, microorganisms including bacteria, viruses, protozoa, and fungi. In addition, animal materials including dairy products (except butter and cheese), and meat products (e.g., meat pies, prepared foods) from countries with livestock diseases exotic to the U.S. Tissue culture materials and suspensions of cell culture grown viruses or other etiologic agents containing growth stimulants of bovine or other livestock origins are controlled by the USDA due to the potential risk of introduction of exotic animal diseases into the U.S.

The USDA, APHIS, Veterinary Services (VS) permit (VS 16-3) may be required to be issued prior to the importation or domestic transfer (interstate movement) of etiologic disease agents of animal (i.e., livestock, poultry, and other animals), or plants, or specimens reasonably believed to contain animal or plant pathogens, any pest or vector of animal or plant disease, or potentially hazardous animal or plant product.

The VS Form 16-3 Permit Application may be found here: http://www.aphis.usda.gov/animal_health/permits/downloads/vs16_3.pdf. Further information may be obtained by calling the USDA/APHIS at (301) 734-7834 or (301) 734-5960, or by visiting: www.aphis.usda.gov/vs and http://www.aphis.usda.gov/animal_health.

U.S. Fish and Wildlife Service permits are required for certain live animals, including bats. Please call 1-800-344-WILD for further information or visit: www.fws.gov/.

The Centers for Disease Control and Prevention's Import Permit Program (IPP) regulates the importation of infectious biological agents, infectious substances, and vectors of human disease into the United States. Prior to issuing an import permit, IPP reviews all applications to ensure that entities have appropriate safety measures in place for working safely with these imported materials.

The CDC Import Permit Program regulates the importation of the following into the United States:

- Naturally occurring or bioengineered infectious agents capable of causing disease in a human.
- Any material that is known or reasonably expected to contain an infectious biological agent.
- Vectors, including animals/animal products (e.g., a mount, rug or other item composed of animal hide, hair, skull, teeth, bones or claws), that are known to transfer or are capable of transferring an infectious biological agent to a human.

A CDC Import Permit is required if your facility imports any etiological agent, any arthropod or other animal host or vector of human disease, or any exotic living arthropod or other animal capable of being a host or vector of human disease.

CDC Etiologic Agent Permit Program information can be found here: <http://www.cdc.gov/od/ohs/biosfty/0753.pdf>, or by phone at (404) 498-2260.

Laboratories are not required to obtain USDA/APHIS permits for select agents. However, USDA/APHIS permits are still needed for Select Agent **Exempt** strains. A list of select agent exempt strains as well as general information, regulations and guidance about Select Biological Agent and Toxins can be found here: <http://www.selectagents.gov/>. The Federal Select Agent Program (FSAP) issued a policy statement in February 2015 regarding when APHIS and CDC Import Permits are not required for the importation or interstate transportation of select agents. This policy change does not affect the permit or transfer requirements for pathogenic plant select agents under 7 CFR § 330 and 7 CFR § 331. The policy statement titled, "APHIS and CDC Import Permits Not Required for the Importation or Interstate Transportation of Select Agents" can be found from the National Select Agent Registry here: <http://www.selectagents.gov/RegPolicyStatement.html>.

REQUEST TO TRANSFER SELECT AGENTS AND TOXINS

The United States Department of Agriculture, Animal and Plant Health Inspection Service (APHIS) develop regulations and guidance in conjunction with the Centers for Disease Control and Prevention (CDC). If a select biological agent or toxin is to be transferred from a facility, an APHIS/CDC Form 2 will be required and must be approved prior to the transfer. The APHIS/CDC Form 2, Request to Transfer Select Agents and Toxins, is used by entities to request prior authorization of a transfer of select agent(s) or toxin(s) from the Federal Select Agent Program as required by regulations (7 CFR § 331, 9 CFR § 121, and 42 CFR § 73).

The APHIS/CDC Form 2 and guidance is available here: <http://www.selectagents.gov/form2.html>

EXPORTS OF INFECTIOUS MATERIALS

A Department of Commerce (DOC) Export License may be required when exporting infectious agents of human, plant, or animal diseases, or genetic material and products which might be used for culture of large amounts of agents. The export of a wide variety of etiological agents of human, plant, and animal diseases may require a license from the Department of Commerce. Information may be obtained by calling the Department of Commerce Bureau of Export Administration at (202) 482-4811 or online at: www.bis.doc.gov/Licensing/. Additional information about the DOC and the Bureau of Industry and Security (BIS) may be found here: <http://www.bis.doc.gov/index.htm>.

SPECIAL PERMITS

DOT and the Pipeline and Hazardous Materials Safety Administration (PHMSA) may issue special permits for certain situations such as those created specifically to transport Ebola virus material during the 2014-2015 outbreak. Special permits may also be issued for the purpose of conducting drills and exercises. LRN Reference Laboratories may request to conduct drills and exercises with Sentinel

Clinical Hospitals and Laboratories that involve the use of special permits. Sentinel Clinical Hospitals and Laboratories are encouraged to work with their LRN Reference Laboratories and State Public Health Laboratories to participate in shipping drills and exercises for laboratory preparedness purposes and to ensure that appropriate permits will be included if needed. The DOT provides additional information about special permits here: <http://phmsa.dot.gov/hazmat/regs/sp-a/special-permits>.

ADDITIONAL RESOURCES AND INFORMATION

For additional information or questions regarding permit application status, whether or not you need a permit, and regulations or policies concerning import, transit, movement or release, please contact:

- **Animals Products:** Telephone Number: (301) 851-3300 Fax Number: (301) 734-8226
- **Plants and Plants Products:** Telephone Number: (301) 851-2046 or Toll free: (877) 770-5990

Email: PlantProducts.Permits@aphis.usda.gov

- **Live Plant Pests, Biological Control Agents, Bees, Parasitic Plants, Federal Noxious Weeds, or Soil:** Telephone Number: (301) 851-2046 or Toll free: (866) 524-5421

Email: Pest.Permits@aphis.usda.gov

- **Select Agents, Organisms and Vectors:** Telephone Number: (301) 851-3300 Fax Number: (301) 851-2239

Email: ov@aphis.usda.gov or asap@aphis.usda.gov

- For more information about APHIS and the National Center for Import and Exports (NCIE), please visit <http://www.aphis.usda.gov/wps/portal/aphis/ourfocus/importexport>.
- Information regarding Import and Export Guidelines and Regulations, or for applying for an Import or Transit Permit can be found here: <http://www.aphis.usda.gov/wps/portal/aphis/resources/permits>.
- **USDA Animal and Plant Inspection Service** <http://www.aphis.usda.gov/wps/portal/aphis/resources/permits>
- **CDC's Division of Global Migration and Quarantine** <http://www.cdc.gov/ncezid/dgmg/>
- **U.S. Fish and Wildlife Service** <http://www.fws.gov/permits/overview/overview.html>
- **U.S. Customs and Border Protection** <http://www.cbp.gov/>
- **Department of Transportation** www.phmsa.dot.gov/hazmat

GUIDANCE

Several organizations provide guidance for infectious shipping regulations and requirements. Clinical Sentinel Laboratories are encouraged to contact their State or Local Public Health Laboratory and/or LRN Reference Laboratory for guidance and assistance whenever submitting a potential biothreat organism such as a select agent rule-out.

The following are some commonly referenced guidance sources:

ASM - THE AMERICAN SOCIETY OF MICROBIOLOGY

The American Society of Microbiology (ASM) provides and maintains the **Sentinel Laboratory Guidelines** for Packing and Shipping of Infectious Substances and is available at:

<http://www.asm.org/images/PSAB/PackAndShip.pdf>

CDC - THE CENTERS FOR DISEASE CONTROL AND PREVENTION

The Centers for Disease Control and Prevention (CDC) provides a free, intermediate-level online course, designed for individual study, and is suitable for those seeking initial training or recertification. Participants are provided with information useful for complying with regulations through use of instructional content and the opportunity to apply knowledge using realistic scenarios. The Hazardous Material Transportation Safety training for laboratorians course can be found here: www.cdc.gov/labtraining.

The CDC publication, Biosafety in Microbiological and Biomedical Laboratories (BMBL), 5th Ed. (CDC/NIH) also provides guidance for infectious shipping and can be found here:

<http://www.cdc.gov/od/ohs/biosfty/bmbl5/bmbl5toc.htm>

DOT - THE UNITED STATES DEPARTMENT OF TRANSPORTATION

The U.S. Department of Transportation (DOT) Hazardous Material Regulations (HMR), Title 49 Code of Federal Regulations (CFR) § 100 – 185 can be found here: <http://www.phmsa.dot.gov/regulations>.

General information about DOT and hazardous materials can be found here:

www.phmsa.dot.gov/hazmat

DOT has published a guidance brochure specifically for infectious substance regulations and requirements and is available here:

https://hazmatonline.phmsa.dot.gov/services/publication_documents/Transporting%20Infectious%20Substances%20Safely.pdf.

The Department of Transportation Hazardous Materials Info Line is 1-800-467-4922.

Hazmat Security Plan guidance can be found here:

https://hazmatonline.phmsa.dot.gov/services/publication_documents/Enhanced_Security_02_22_12%201.pdf

DOT free publications: https://hazmatonline.phmsa.dot.gov/services/Pub_Free.aspx

IATA - THE INTERNATIONAL AIR TRANSPORT ASSOCIATION

The International Air Transport Association Dangerous Goods Regulations can be found here:

<http://www.iata.org/publications/dgr/Pages/index.aspx>

<http://www.iata.org/whatwedo/cargo/dgr/Pages/index.aspx>

LRN - THE LABORATORY RESPONSE NETWORK

LRN Reference Laboratories offer and provide packaging and shipping guidance and trainings to LRN Sentinel Laboratories in their respective jurisdictions. Sentinel laboratories are encouraged to contact their State or Local LRN Reference Laboratory for assistance.

STATE AND LOCAL PUBLIC HEALTH LABORATORIES

A list of State and Local Public Health Laboratories is available from the Association of Public Health Laboratories (APHL), and is available here:

<http://www.aphl.org/membership/Pages/memberlabs.aspx>

WHO - THE WORLD HEALTH ORGANIZATION

The World Health Organization (WHO) provides guidance on the regulations for the transport of infectious substances which can be found here:

<http://www.who.int/ihr/publications/biosafety/en/>

This interactive guidance tool “Guide for Shippers of Infectious Substances” was originally developed to assist shippers with classifying, documenting, marking, labelling, and packaging infectious substances including refrigeration of infectious substances with ice pads, dry ice and using dry shippers. http://www.who.int/ihr/infectious_substances/en/

COMMERCIAL COURIERS

Commercial couriers such as Airborne Express, ARUP, DHL, FedEx, Mayo, Saf-T-Pak, UPS, World Courier, etc., may offer and provide their own guidance or training for infectious substance shipping compliance. If you are using a commercial courier, please contact them for any training or compliance assistance they may provide.

The FedEx Dangerous Goods / Hazardous Material Hotline 1-800-463-3339, press 81

Current Requirements

<http://www.fedex.com/us/hazardous-materials/current-requirements/>

FedEx Dangerous Goods Training

<http://www.fedex.com/us/hazardous-materials/training/>

FedEx Dangerous Goods Resources

<http://www.fedex.com/us/service-guide/ship-dg-hazmat/dangerous-goods/resources.html>

FedEx dry ice job aid

http://images.fedex.com/us/services/pdf/Dry_Ice_Job_Aid.pdf

SUPPLIES

Appropriately packaging and shipping infectious substances will require several needed supplies. The tables below are intended to provide recommended sources of some commonly used vendors and supplies, although this guidance does not specifically endorse any since several vendors sell similar products.

Category A and B shipping containers are required to pass specific performance tests prior to their use. It is recommended to purchase supplies that meet the required standards rather than attempting to demonstrate your own packaging passes the tests. It is the responsibility of the packaging manufacturer and the person who offers hazardous materials for transportation; to the extent that assembly functions including final closure is performed by the latter, to assure that each package is capable of passing the prescribed tests.

PERFORMANCE TESTS

The following tests are performed as appropriate for each type of package: Drop Test, §178.603; Leakproofness Test, §178.604; Hydrostatic pressure Test, §178.605; Stacking Test, §178.606; Cooperage Test for Bung-type Wooden Barrels, §178.607; Chemical Compatibility Test for Plastic Receptacle, §178.608; Vibration Standard, §173.24a(a)(5).

NOTE: Each section must be consulted to determine the applicable test for each type of container.

PACKAGE TESTING

Package testing consists of the following: Design Qualification Testing, §178.601(c)(1); Periodic Retesting, §178.601(c)(2); Production Testing, §178.601(c)(3); Frequency of Periodic Testing, §178.601(e); Test Samples, §178.601(f).

The person who manufactures a package subject to the requirements of the hazardous materials regulations is responsible to insure the package is in conformance with the requirements contained in 49 CFR §178. When a package is required to be marked with a UN standard or DOT specification, the package must meet all the requirements of the regulation, including testing. The manufacturer or person certifying that the package is in compliance with §178 must inform in writing each person to whom the packaging is transferred of all requirements of §178 not met at time of transfer, and all actions that need to be taken for the package to conform to requirements of Part 178. The written statements must be retained by the manufacturer for at least one year per 49 CFR § 178.2(c). When filling packages with hazardous materials the shipper must comply with these written instructions.



PERFORMANCE ORIENTED PACKAGE MARKING

The Manufacturer's Marking Requirement is contained in 49 CFR § 178.503 and cover the following:

- The United Nations symbol
- Packaging identification code consisting of:
 - Type of packaging.
 - Material of construction.
 - Category of packaging (when appropriate).
 - A letter identifying the performance standard.
 - X - Meeting packing group I, II and III tests
 - Y - Meeting packing group II and III tests
 - Z - Meeting only packing group III tests
 - Specific gravity or mass (Specific gravity for packaging without inner linings designed to hold liquids rounded down to the first decimal for those non-viscous liquids having a specific gravity greater than 1.2. Maximum gross mass in kilograms for viscous liquids, solids, or inner packagings).
 - A letter "S" for packaging intended only for solids or inner packagings, test pressure in kilopascals of the hydrostatic test pressure.
 - The last two digits of the year of manufacture.
 - The letters indicating the country of origin (e.g., "USA").
 - The name and address or symbol of the person applying the marks.
 - Other markings as applicable, such as:
 - Month of manufacture for plastic drums (1H) and jerricans(3H). May be marked in a different location. Minimum thickness of packaging material in millimeters (mm) for metal or plastic drums or jerricans intended for reuse.
 - Tare weight preceded by "TW" for packaging intended for nitric acid.
- Reconditioned packaging. Items 1-6 and thickness in millimeters must be applied in a permanent manner able to withstand reconditioning. The following additional markings are required:
 - Name of the country in which the reconditioning was performed.
 - Name and address or symbol of the reconditioner.
 - Month and last two digits of the year of reconditioning.
 - The letter "R".
 - The letter "L" for packaging passing a leakproofness test.

DIAGRAM 21. UN SYMBOL MARKING EXAMPLE

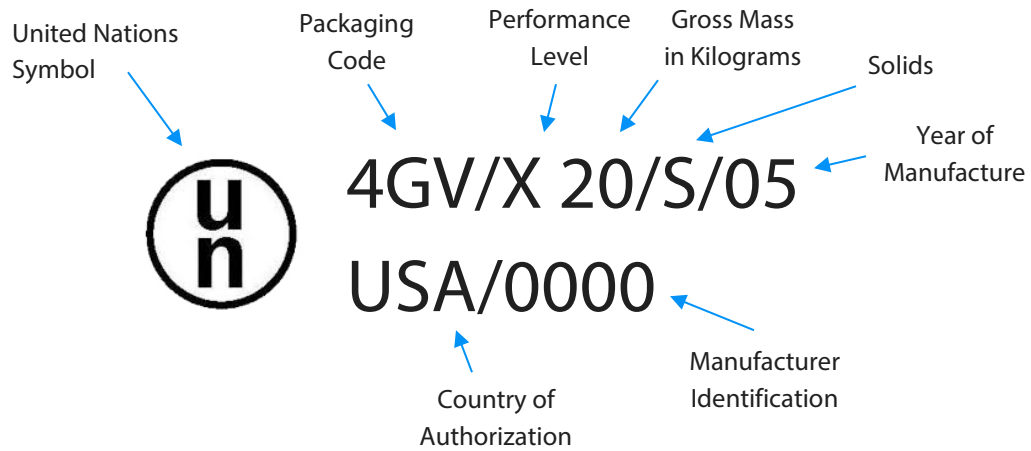

For additional information, please visit: <http://www.fmcsa.dot.gov/regulations/hazardous-materials/how-comply-federal-hazardous-materials-regulations#sthash.TfG2iPEj.dpuf>.

TABLE 4. CATEGORY A SUPPLIES TABLE

Category A Supplies		
Item	Vendor	Catalog #
Category A Packaging Unit (Ambient temperature)	Fisher Scientific	22-130-074
	Saf-T-Pak / Inmark	STP-100 Reusable Shipping System STP-110 or STP-130 Shipping Systems
Category A Packaging Unit (Frozen or refrigerant temperature, dry ice)	Fisher Scientific	19-038-301A
	Saf-T-Pak / Inmark	STP-310 Shipping System, Insulated
Category A Division 6 Hazard Diamond Label	LabelMaster	LR17
	Or included when purchasing above shipping systems	
UN2814 Label	Included when purchasing above shipping systems	
Shipper's Declaration for Dangerous Goods	FedEx Ship Manager	N/A
	Saf-T-Pak / Inmark	FedEx Express FX-18 Recognized Online Fillable Form
Red-hatched paper for Shipper's Declarations	FedEx	157295
	Included when purchasing above shipping systems	
Biohazard Label	Fisher Scientific	18-999-931
	Included when purchasing above shipping systems	
95 kPa Bags	Saf-T-Pak / Inmark	STP-700, STP-710, STP-730
	Included when purchasing above shipping systems	
Absorbent Material	Saf-T-Pak / Inmark	STP-148, STP-152, STP-155
	Included when purchasing above shipping systems	
FedEx label	Fed Ex Ship Manager	N/A
FedEx Label Envelope	Fed Ex	158396

TABLE 5. CATEGORY B SUPPLIES TABLE

Category B		
Item	Vendor	Catalog #
Category B Packaging Unit (Ambient temperature)	Fisher Scientific	22-130-027
	Saf-T-Pak / Inmark	STP-200 Reusable Shipping System STP-210, 250, 270 Shipping Systems
UN3373 Biological Substance Label	Fisher Scientific	221130067
	Included when purchasing above shipping systems	
Category B Packaging Unit (Frozen or refrigerant temperature, dry ice)	Fisher Scientific	22-130-113
	Saf-T-Pak / Inmark	STP-308, 309, 320, or 340 Shipping Systems
FedEx Label	Fed Ex Ship Manager	N/A
FedEx Label Envelope	Fed Ex	158396
Biohazard Label	Fisher Scientific	18-999-931
	Included when purchasing above shipping systems	

TABLE 6. OVERPACK SUPPLIES TABLE

Overpack		
Item	Vendor	Catalog #
Overpack Label	LabelMaster	L370
Category B Clinical Pak	Fed Ex	163034

TABLE 7. DRY ICE B SUPPLIES TABLE

Dry Ice		
Item	Vendor	Catalog #
UN1845 Division 9 Label	Fed Ex	106426
Dry Ice	Shop Local	



The CDC offers a partial listing of shipping container suppliers that provide products that satisfy DOT, IATA, ICAO and PHS Division 6.2 infectious substance shipping container requirements.

Air Sea Containers, Inc.

<http://www.airseacontainers.com>

Berlin Packaging, LLC

<http://berlindangerousgoods.com/en/products>

CARGOpak Corporation

<http://www.cargopak.com>

Labeline

http://www.labeline.com/store_uk

Inmark, Inc.

<http://www.inmarkpackaging.com>

O'Berk International, Inc. (Elemental Container, Inc.)

<http://aluminumbottles.com>

SCA ThermoSafe (formerly Polyfoam Packers Corp.)

<http://www.thermosafe.com>





Saf-T-Pak, Inc., An Inmark Company

<http://www.saftpak.com>

In addition to the above supplies, you will need to mark the package with the shipper/sender information and the recipient/consignee information. When shipments will include dry ice, consider locating a source you may obtain from near your laboratory since the dry ice will sublime rapidly and must be used promptly.

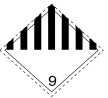

TABLE 8. SUMMARY TABLE

Summary Table of Shipping Information											
SHIPPING CLASSIFICATION				GROUND Transport			AIR Transport				
Shipment Type	Proper Shipping Name	UN Number	Hazard Class	Hazard Label	Packing Instruction	Max Net Qty/Pkg	Packing Group	IATA Packing Instruction	Passenger Aircraft Max Net qty/pkg	Cargo Aircraft Max Net qty/pkg	Special Provisions and Restrictions
Category A Infectious Substance, Affecting Humans (Note: and possibly animals)	Infectious Substance, Affecting Humans (<i>technical name of organism</i>)	UN 2814	6.2		620	No Limit	None	620	50mL or 50g	4L or 4kg	A81, A82, A140, (R)134
Category A Infectious Substance, Affecting Animals (Note: affecting animals only and not humans)	Infectious Substance, Affecting Animals (<i>technical name of organism</i>)	UN 2900	6.2		620	No Limit	None	620	50mL or 50g	4L or 4kg	A81, A82, A140, (R) 134
Category B infectious substance	Biological Substance, Category B	UN 3373	6.2		650	No Limit	None	650	4L or 4kg	4L or 4kg	A82, (R) 134
Dry Ice	Dry Ice, or Carbon dioxide, solid	UN 1845	9		954	200kg	None	954	200kg	200kg	A48, A151, A805, (R)217
Non-infectious, transducing genetically modified organism or microorganism (GMO)	Genetically modified micro-organisms	UN 3245	9		959	No Limit	None	913	No Limit	No Limit	A47

NOTE: GMMOs & GMOs which meet the definition of an infectious substance Category A or B and the criteria for inclusion in Class 6.2 must be transported as UN 2814, 2900 or 3373 as appropriate instead of UN3245.

WHO A GUIDE FOR SHIPPERS OF INFECTIOUS SUBSTANCES, 2015-2016

http://www.who.int/ihr/infectious_substances/en/

This interactive guidance tool “Guide for Shippers of Infectious Substances” was originally developed to assist shippers with classifying, documenting, marking, labelling, and packaging infectious substances including refrigeration of infectious substances with ice pads, dry ice and using dry shippers.

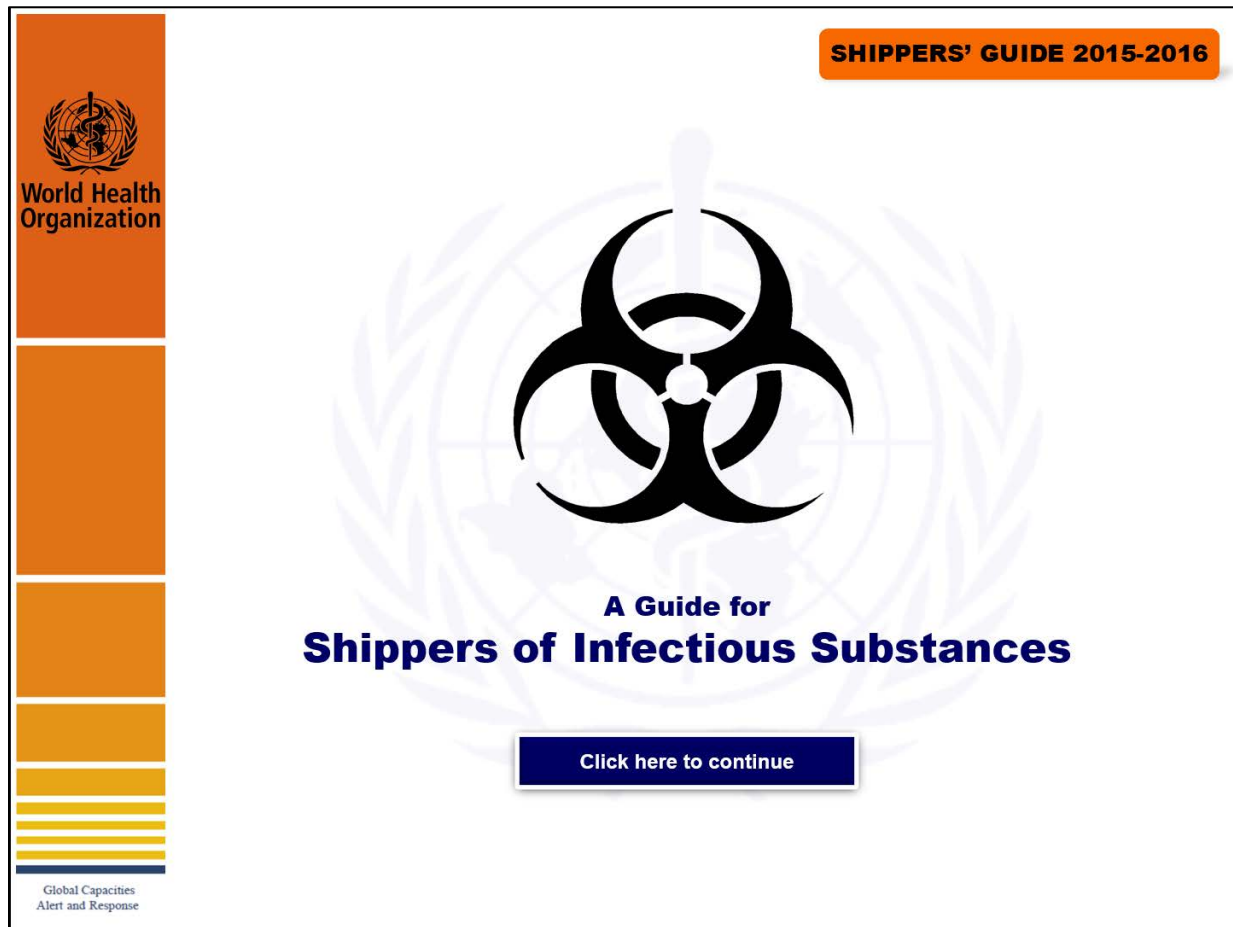

SHIPPERS' GUIDE 2015-2016

World Health Organization

**A Guide for
Shippers of Infectious Substances**

Click here to continue

Global Capacities
Alert and Response

CHECKLIST 1. CATEGORY A GUIDANCE CHECKLIST

Category A infectious material must be characterized as one of the following:

- UN 2814 Infectious Substances, Affecting Humans (*technical name of organism*)
- UN 2900 Infectious Substance, Affecting Animals (*technical name of organism*)
- Suspected Category A (*technical name of organism*)

Category A shipments must be triple packed in a UN certified package with appropriate and accompanying documentation. Category A shipments must be compliant in accordance with the applicable and current IATA Dangerous Goods Requirements following Packing Instruction 620, and the U.S. DOT Hazardous Material Regulations as listed in Title 49 of the CFR, Parts 100 – 185.

PRIMARY CONTAINER

Contains appropriate specimen/material identifying information such as a patient identification number.

Primary containers must be a securely sealed leak proof container. Leak proof = watertight and sealed, such as a screw cap receptacle and Parafilm. Primary containers can be glass, metal, or plastic.

Note: a Petri dish alone or with Parafilm is not an acceptable primary container for regulated shipping purposes because it does not form a leak proof and watertight seal.

Wrapped in absorbent material sufficient for entire contents of hazardous material and type (liquid or solid).

Wrapped in cushioning material as needed to provide structural integrity support. If multiple primary containers are included, individually wrap each one.

Note: Absorbent material can also be used as cushioning material.

Primary **OR** secondary container must be pressure resistant (95kPa compatible).

Note: Multiple primary containers are permitted to be included inside a secondary container.

SECONDARY CONTAINER

Secondary container is a securely sealed leak proof container. Leak proof = watertight and sealed.

Primary **OR** secondary container pressure resistant (95kPa compatible).

A biohazard symbol must be displayed on the outside of the secondary container.

A completed itemized list of contents (i.e. test requisition or sample submission form) is placed between the secondary packaging and the outer packaging, NOT inside the secondary packaging container.

- Absorbent material is placed between the primary and secondary packaging.
- (Optional) Additional cushioning material placed between primary and secondary as needed.

OUTER PACKAGE (UN CERTIFIED)

- Outer box contains the UN certified package markings indicating it meets the package test requirements.
- Quantity of hazardous material must be listed on outside of box in volume (mL) or weight (g).
 - Cannot exceed 50mL or 50g if shipped in passenger aircraft.
 - Cannot exceed 4L or 4kg if shipped in cargo aircraft.
 - *If dry ice is used*, the quantity of dry ice included must be listed on the outside package.
- Orientation marks (Up Arrows) on two opposite sides of the outer packaging if shipping liquids greater than 50mL.
- Full name, complete address and phone number of the **Responsible Person** for the shipment.
 - (This can be either the shipper or the recipient, but must be someone knowledgeable of the contents).
- Full name, complete address and telephone number of the **shipper**.
- Full name, complete address and telephone number of the **consignee/recipient**.
- Marked with the appropriate UN identification number and proper shipping name as characterized:
 - UN 2814 Infectious Substances, Affecting Humans
 - UN 2900 Infectious Substance, Affecting Animals
 - Suspected Category A Infectious Substance

NOTE: Special Provision A140 states; technical name can be omitted on outer package. (However, the technical name of organism must still be listed on the Shipper's Declaration form).
- Class 6 diamond shape label on the outer package with Public Health notification in case of spill.
- 24 Hour Emergency Contact** number must be listed.
- Include multiple signed copies (at least 3) of Shipper's Declaration on outside of package.
- Include any permits that may be required.

CHECKLIST 2. SHIPPER'S DECLARATION GUIDANCE CHECKLIST

SHIPPER'S DECLARATION FOR DANGEROUS GOODS				(Provide at least 2 copies to the airline.)		
Shipper		Air Waybill No.				
Consignee		Page of Pages				
Two completed and signed copies of this Declaration must be handed to the operator		Shipper's Reference Number				
TRANSPORT DETAILS This shipment is within the limitations prescribed for: (delete non applicable) <input type="checkbox"/> PASSENGER AND CARGO AIRCRAFT <input type="checkbox"/> CARGO AIRCRAFT ONLY		Airport of Departure Airport of Destination:				
		WARNING Failure to comply with all respects with the applicable Dangerous Goods Regulations may be in breach of the applicable law, subject to legal penalties.				
		Shipment type: (delete non-applicable) <input type="checkbox"/> NON-RADIOACTIVE <input type="checkbox"/> RADIOACTIVE				
NATURE AND QUANTITY OF DANGEROUS GOODS						
Dangerous Goods Identification				Quantity and type of packaging	Packing Inst.	Authorization
UN or ID No.	Proper Shipping Name	Class or Division (Subsidiary Risk)	Pack-ing Group			
Additional Handling Information						
Emergency Telephone Number:						
I hereby declare that the contents of this shipment are fully and accurately described above by the proper shipping name, and are classified, packaged, marked and labelled/placarded, and are in all respects in proper condition for transport according to applicable International and National Governmental Regulations. I declare that all of the applicable air transport requirements have been met.				Name/Title of Signatory		
				Place and Date		
				Signature (see warning above)		
				Emergency Telephone Number		
FOR RADIOACTIVE MATERIAL SHIPMENT ACCEPTABLE FOR PASSENGER AIRCRAFT, THE SHIPMENT CONTAINS RADIOACTIVE MATERIAL INTENDED FOR USE IN OR INCIDENT TO RESEARCH, MEDICAL DIAGNOSIS, OR TREATMENT. ADR EUROPEAN TRANSPORT STATEMENT: CARRIAGE IN ACCORDANCE WITH 1.1.4.2.1						

1. Full name, address and phone number of shipper
2. Enter Airway Bill No. (if using commercial carrier to verify payment).
 - a. Page __ of __ Pages (# of copies included)
 - b. (Optional) Enter the specimen ID # reference
3. Full name, address and phone number of recipient/consignee
4. Cross out the type of shipment which does not apply (cargo vs. passenger aircraft)
 - a. **Note:** Greater than 50mL or 50g of Category A will require Cargo Aircraft Only, Quantities below this limit are allowed on the cargo of Passenger Aircraft
 - b. **Cross out the "Cargo Aircraft Only" box (unless more than 50mL)**
 - c. Airport of departure and destination will be filled out by carrier –(OK to Leave Blank)
 - d. Cross out the words "Radioactive"
5. UN ID number of shipment
 - a. UN2814 for Category A
 - b. UN1845 for dry ice
6. Proper shipping name of sample followed by organism name in parenthesis
 - a. **Example:** Category A Infectious Substance, affecting humans (*Yersinia pestis*)
7. Hazard Class or Division (6.2 or 9 for dry ice)
8. Packing Group in Roman Numerals
9. Quantity (in mL or g) & Type (liquid or solid)
 - a. **Examples:** 5mL, solid
 - b. Packaged in one fiberboard box
 - c. Overpack Used
10. Packing Instruction (620, 650, 954)
11. Authorization (can leave blank)
12. Additional Information (list responsible person)
13. 24-Hour Emergency phone number (must be a live person able to answer during the transport)
14. Full Name and Job Title, place of shipment origin and date. **Signature** of Shipper.
15. **Sign** and color print MINIMUM 3 copies.
 - a. Recommended to print 4 and to keep one additional for your records



CHECKLIST 3. FEDEX SHIPPER'S DECLARATION CHECKLIST

http://images.fedex.com/us/services/pdf/DG_NRChecklist_Sample_2015.pdf



Dangerous Goods Acceptance Checklist Sample Declaration- 2015

Page 1 of 2

The highlighted numbers correspond to those found on the 2015 FedEx Express Non-Radioactive Acceptance Checklist.

(Provide at least three copies to the airline.)

Shipper 7 Shipper name and address	Air Waybill No. 10 Page 1 of 1 Pages Shipper's Reference Number <i>(optional)</i>		
Consignee 7 Consignee name and address			
Two completed and signed copies of this Declaration must be handed to the operator			
TRANSPORT DETAILS This shipment is within the limitations provided for: 11 <i>(delete non-applicable)</i> <table border="1" style="width: 100%; border-collapse: collapse;"> <tr> <td style="width: 50%; text-align: center;">PASSENGER AND CARGO AIRCRAFT</td> <td style="width: 50%; text-align: center;">CARGO AIRCRAFT ONLY</td> </tr> </table> Airport of Departure Airport of Destination	PASSENGER AND CARGO AIRCRAFT	CARGO AIRCRAFT ONLY	WARNING Failure to comply in all respects with the applicable Dangerous Goods Regulations may be in breach of the applicable law, subject to legal penalties.
PASSENGER AND CARGO AIRCRAFT	CARGO AIRCRAFT ONLY		
Shipment type: 12 <i>(delete non-applicable)</i> <input type="checkbox"/> NON-RADIOACTIVE <input type="checkbox"/> RADIOACTIVE			
NATURE AND QUANTITY OF DANGEROUS GOODS			
13 14 15, 16 17 UN or ID Number, Proper Shipping Name, Hazard Class, Packing Group //			
18 19 Number and Type of package x quantity //			
20 Packing Instruction //			
21 Authorizations			
Additional Handling Information <div style="display: flex; justify-content: space-around; align-items: center;"> ← 23 22 → </div>			
I hereby declare that the contents of this consignment are fully and accurately described above by the proper shipping name, and are classified, packaged, marked and labeled/placarded, and are in all respects in proper condition for transport according to applicable International and National Governmental Regulations. I declare that all of the applicable air transport requirements have been met.	Name/Title of Signatory Place and Date 24 Signature <i>(see warning above)</i>		
Emergency Telephone Number			
FOR RADIOACTIVE MATERIAL SHIPMENT ACCEPTABLE FOR PASSENGER AIRCRAFT, THE SHIPMENT CONTAINS RADIOACTIVE MATERIAL INTENDED FOR USE IN OR INCIDENT TO RESEARCH, MEDICAL DIAGNOSIS, OR TREATMENT. ADR EUROPEAN TRANSPORT STATEMENT: CARRIAGE IN ACCORDANCE WITH 1.1.4.2.1			

Printed or other static representations of this document are considered uncontrolled and for reference only.

EFFECTIVE: 01/01/15 REVISION: 01/01/15

The highlighted numbers correspond to those found on the 2015 FedEx Express Non-Radioactive Acceptance Checklist.

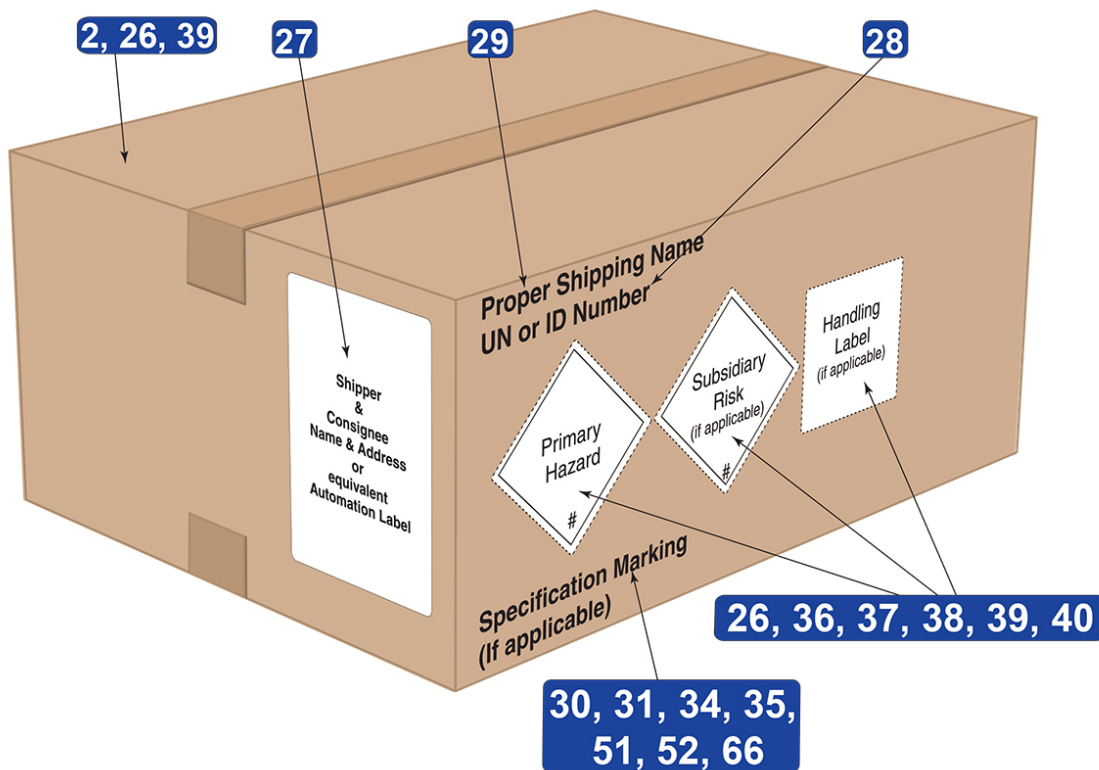

FedEx Express offers IATA-endorsed seminars to help you understand dangerous goods regulations and avoid costly fines. Refer to our seminar schedule at <http://www.fedex.com/us/hazardous-materials/training/index.html> for more information.

To purchase a current IATA Manual from FedEx Express refer to url: <https://fedex.registration.meetingevolution.net/index.php/dg-publications-for-sale.html>

Need to monitor the status of your shipment?
Ask your account executive for information about FedEx Insight®.

Want immediate notification of status?
Ask about FedEx Priority Alert® service.

Printed or other static representations of this document are considered uncontrolled and for reference only.

EFFECTIVE: 01/01/15 REVISION: 01/01/2015



CHECKLIST 4. FEDEX SHIPPER'S DECLARATION VERIFICATION CHECKLIST

Current FedEx Dangerous Good Guidance

<http://www.fedex.com/us/service-guide/ship-dg-hazmat/dangerous-goods/resources.html>



NON-RADIOACTIVE 2015 DG Acceptance Checklist

Tracking # _____ Date _____

The continued offering of non-compliant dangerous goods packages may result in the embargo of your dangerous goods shipments by FedEx Express.

DIRECTIONS: Mark the appropriate box for each item to indicate if the shipment complies with the requirement.

ORM-D-AIR shipments are prohibited. These shipments must be prepared using the IATA Dangerous Goods Regulations. [HM-215K]		<input type="checkbox"/> Y <input type="checkbox"/> N
1. DG shipment acceptable to destination location. [SRG]	<input type="checkbox"/> Y <input type="checkbox"/> N	
2. Package in good condition and free of leakage, odor, or external damage. [5.0.2.4.1]	<input type="checkbox"/> Y <input type="checkbox"/> N	
3. 023 air waybill (IP1, IXF, ATA): Correct statements, as appropriate, in Handling Information box. [8.2.1]	<input type="checkbox"/> Y <input type="checkbox"/> N <input type="checkbox"/> N/A	
4. Shipment not forbidden. [4.2]	<input type="checkbox"/> Y <input type="checkbox"/> N	
5. If A20 in blue pages, Keep Away From Heat label, declaration statement, and technical name when required per Appendix Tables C.1 or C.2. [7.2.4.5; 8.1.6.9.4 (f)]	<input type="checkbox"/> Y <input type="checkbox"/> N <input type="checkbox"/> N/A	
6. Shipper's declaration included. [8.0.1.1]	<input type="checkbox"/> Y <input type="checkbox"/> N	
ON THE DECLARATION ONLY		
Tracking number may be completed by Shipper or DG Specialist. Shipper must provide 3 copies in English and at least 2 copies with red hatchings. (FX-14)		
7. Shipper and Consignee name and full address. For 023 shipments, shipper's address includes country name. [8.1.6.1; 8.1.6.2]	<input type="checkbox"/> Y <input type="checkbox"/> N	
8. Shipper's Declaration prepared per FX-18 (does not apply to 023 shipments or shipments originating in U.S. territories or non-U.S. locations).	<input type="checkbox"/> Y <input type="checkbox"/> N <input type="checkbox"/> N/A	
9. Typewritten or computer-generated. [FX-12]	<input type="checkbox"/> Y <input type="checkbox"/> N	
10. Page of Pages. [8.1.6.4]	<input type="checkbox"/> Y <input type="checkbox"/> N	
11. Passenger and Cargo Aircraft or Cargo Aircraft Only limitations indicated. [8.1.6.5]	<input type="checkbox"/> Y <input type="checkbox"/> N	
12. Non-radioactive indicated. [8.1.6.8]	<input type="checkbox"/> Y <input type="checkbox"/> N	
13. UN or ID number preceded by prefix "UN" or "ID". [8.1.6.9.1]	<input type="checkbox"/> Y <input type="checkbox"/> N	
14. Proper Shipping Name, including technical name in parentheses () or "SAMPLE" for ★ entries. UN 2814 or UN 2900: Technical name in parentheses or "suspected category A infectious substance" in parentheses. [3.11.2; 4.1.2.1 (d); 8.1.6.9.1, Step 2]	<input type="checkbox"/> Y <input type="checkbox"/> N	
15. Class or Division number(s), and when 1.4 indicated, Compatibility Group letter included (handwritten acceptable), matching Column C of 4.2. [8.1.6.9.1, Step 3]	<input type="checkbox"/> Y <input type="checkbox"/> N	
16. Subsidiary risk(s) in parentheses () immediately following class or division, matching Column C of 4.2. [8.1.6.9.1, Step 4]	<input type="checkbox"/> Y <input type="checkbox"/> N <input type="checkbox"/> N/A	
17. Packing Group (e.g., I, II, or III), matching column E. If SAMPLE used as technical name, Shipper selects most restrictive packing group for Proper Shipping Name. [3.11.1; 8.1.6.9.1, Step 5]	<input type="checkbox"/> Y <input type="checkbox"/> N <input type="checkbox"/> N/A	
18. Number of packages and type of packaging (e.g., 1 fibreboard box, 1 box fibreboard, or 1 4G fibreboard box). [8.1.6.9.2, Step 6]	<input type="checkbox"/> Y <input type="checkbox"/> N	
19. Net quantity or gross weight per package (in metric units), not exceeding Packing Instruction maximum per package. [8.1.6.9.2, Step 6 (a)]	<input type="checkbox"/> Y <input type="checkbox"/> N	
20. Packing Instruction (e.g., 361 or Y441). [8.1.6.9.3]	<input type="checkbox"/> Y <input type="checkbox"/> N	
21. If required by State or Operator variation, Competent Authority or DOT-SP/E approval number indicated on declaration and approval document attached when needed. [8.1.6.9.4, Step 9 (b)]	<input type="checkbox"/> Y <input type="checkbox"/> N <input type="checkbox"/> N/A	
22. "I declare that all of the applicable air transport requirements have been met" statement. [8.1.6.12.2]	<input type="checkbox"/> Y <input type="checkbox"/> N	
23. 24-hour emergency response telephone number if required by State or Operator variation. [2.8; USG-12]	<input type="checkbox"/> Y <input type="checkbox"/> N <input type="checkbox"/> N/A	
24. Name, title, place, date, and shipper's signature (may be typewritten for U.S. domestic shipments, including U.S. territories). [8.1.4.1; 8.1.6.13-15]	<input type="checkbox"/> Y <input type="checkbox"/> N	
25. Shipper's same signature next to amendments and alterations (changes). [8.1.2.6]	<input type="checkbox"/> Y <input type="checkbox"/> N <input type="checkbox"/> N/A	
ON THE PACKAGE ONLY		
26. Number and type of packaging corresponds to declaration, large enough to support all markings, labels, documentation and none placed on bottom of package. FedEx branded packaging, including brown boxes, not used. [5.0.1.2; 5.0.2.4; FX-11]	<input type="checkbox"/> Y <input type="checkbox"/> N	
27. Shipper and Consignee name and full address marked on package. [7.1.4.1 (b)]	<input type="checkbox"/> Y <input type="checkbox"/> N	
28. UN or ID number preceded by prefix "UN" or "ID" and meets size requirements. [7.1.4.1 (a); 7.1.4.4]	<input type="checkbox"/> Y <input type="checkbox"/> N	
29. Proper Shipping Name, including technical name in parentheses () or "SAMPLE" for ★ entries. Technical name not required for UN 2814 or UN 2900. [7.1.4.1 (a); A140]	<input type="checkbox"/> Y <input type="checkbox"/> N	
30. Package permitted by Packing Instruction unless overpacked. [Section 5]	<input type="checkbox"/> Y <input type="checkbox"/> N	
31. (X, Y, Z) packaging: Package type code, performance rating (X, Y, Z) corresponds with Packing Group (I, II or III) unless further limited by Packing Instruction, Special Permit, or Special Provision and does not exceed gross weight capacity (not required for Overpack). Handwritten specification markings unacceptable. [6.0.4]	<input type="checkbox"/> Y <input type="checkbox"/> N <input type="checkbox"/> N/A	
32. More than one package, net quantity or gross weight (G) as indicated in columns H, J, and L marked on package. Not applicable to ID 8000 or when contents are same UN#, PSN, packing group, and quantity. [7.1.4.1 (c)]	<input type="checkbox"/> Y <input type="checkbox"/> N <input type="checkbox"/> N/A	
33. Dry Ice: Net weight marked on package in kilograms. [7.1.4.1 (d)]	<input type="checkbox"/> Y <input type="checkbox"/> N <input type="checkbox"/> N/A	
34. UN 3356: Package marked with DOT31FP specification marking unless overpacked. [FX-13; USG-18]	<input type="checkbox"/> Y <input type="checkbox"/> N <input type="checkbox"/> N/A	
35. For U.S. domestic shipments, DOT-SP/E approval number when required (including Puerto Rico).	<input type="checkbox"/> Y <input type="checkbox"/> N <input type="checkbox"/> N/A	
36. Primary hazard label(s), matching column D. Hazard label on same surface as Proper Shipping Name marking when package dimensions are adequate. [7.2.3; 7.2.6.2]	<input type="checkbox"/> Y <input type="checkbox"/> N <input type="checkbox"/> N/A	
37. Subsidiary risk label(s), matching column D, affixed on same surface of package near hazard label(s) when required. [7.2.3; 7.2.6.2]	<input type="checkbox"/> Y <input type="checkbox"/> N <input type="checkbox"/> N/A	
38. Cargo Aircraft Only label when required must be affixed on same surface of package near hazard label(s). [7.2.4.2; 7.2.6.3]	<input type="checkbox"/> Y <input type="checkbox"/> N <input type="checkbox"/> N/A	
39. Markings and label(s) meeting IATA specifications, correctly applied (not obscured or covering required markings); irrelevant markings/labels removed or obliterated. [7.1; 7.2]	<input type="checkbox"/> Y <input type="checkbox"/> N	
40. If UN 3077 or UN 3082, the Environmentally hazard marking is required. [7.1.5.3]	<input type="checkbox"/> Y <input type="checkbox"/> N <input type="checkbox"/> N/A	
LIMITED QUANTITY OR LTD QTY		
"Y" marking not more than 50% smaller than standard size may be used. [Figure 7.1.A]		
41. Limited Quantity "Y" marking on package when Y packing instruction used. [Figure 7.1.A]	<input type="checkbox"/> Y <input type="checkbox"/> N	
42. Gross weight of package must not exceed 30 kg (66 lb) unless Overpacked. [2.7.4.2]	<input type="checkbox"/> Y <input type="checkbox"/> N	



NON-RADIOACTIVE 2015 DG Acceptance Checklist

Tracking # _____ Date _____

The continued offering of non-compliant dangerous goods packages may result in the embargo of your dangerous goods shipments by FedEx Express.

EXPLOSIVES (CLASS 1) N/A	
43. If 023 air waybill, required by state variation (e.g. Singapore), or originating in a non-U.S. location, FedEx pre-approval required. [FX-01]	<input type="checkbox"/> Y <input type="checkbox"/> N <input type="checkbox"/> N/A
44. If required by State or Operator variation, approval attached and/or approval number indicated on declaration, or marked on outer package, or both. [8.1.6.9.4; USG-05; USG-16] For U.S., not required for ammunition, including Cartridges, Small Arms: <ul style="list-style-type: none"> • IHC, NSN or DOT-SP/E: Approval number on declaration and (when required) by Special Permit marked on package. Paperwork accompanies shipment. OR • CA, EX or FC: Approval number on declaration and/or package. 	<input type="checkbox"/> Y <input type="checkbox"/> N <input type="checkbox"/> N/A
45. Primary hazard label for explosives includes Compatibility Group letter (may be handwritten). [7.2.3.3 (b)]	<input type="checkbox"/> Y <input type="checkbox"/> N
46. Net Explosive Mass (NEQ, NEM, NEW, or NEC) shown on declaration. [8.1.6.9.2, Step 6 (i); Appendix A]	<input type="checkbox"/> Y <input type="checkbox"/> N
47. Packing Instruction 101: Competent Authority statement on declaration.	<input type="checkbox"/> Y <input type="checkbox"/> N <input type="checkbox"/> N/A
48. Fireworks 1.4G or Fireworks 1.4S: Shipper on Fireworks Shipper Approval list.	<input type="checkbox"/> Y <input type="checkbox"/> N <input type="checkbox"/> N/A
49. Fireworks (UN 0336 or UN 0337): Declaration includes Classification reference by appropriate Competent Authority (e.g. GB/HSE123456, USA EX20091234, etc.). [8.1.6.11.5]	<input type="checkbox"/> Y <input type="checkbox"/> N <input type="checkbox"/> N/A
GASES (CLASS 2) N/A	
Labels of reduced size may be affixed to the shoulder of a compressed gas cylinder.	
50. Compressed Gas Cylinder (outer package): Specification markings stamped, engraved or etched. [6.4.2.7.2; applicable packaging instruction]	<input type="checkbox"/> Y <input type="checkbox"/> N <input type="checkbox"/> N/A
51. UN 1070, UN 2451, UN 3156 or UN 3157: Rigid outer packaging and marked DOT31FP (unless Overpack). [FX-13; USG-18]	<input type="checkbox"/> Y <input type="checkbox"/> N <input type="checkbox"/> N/A
52. UN 1072: In ATA Specification 300/Category I container and DOT31FP (unless Overpack). [FX-13; USG-18]	<input type="checkbox"/> Y <input type="checkbox"/> N <input type="checkbox"/> N/A
53. UN 1057 Lighters (excludes lighter refills): Approval number on declaration and marked on package. [USG-07]	<input type="checkbox"/> Y <input type="checkbox"/> N <input type="checkbox"/> N/A
Packing Instruction 202: N/A	
54. Required markings per PI202 and Cryogenic label. [7.1.4.1 (f); 7.2.4.3]	<input type="checkbox"/> Y <input type="checkbox"/> N
55. "DO NOT DROP - HANDLE WITH CARE" on package. [7.1.4.1 (f)]	<input type="checkbox"/> Y <input type="checkbox"/> N
56. "KEEP UPRIGHT" at 120-degree intervals around cylinder or on each side of package. [7.1.4.1 (f)]	<input type="checkbox"/> Y <input type="checkbox"/> N
57. Two Package Orientation labels (Up Arrows). [7.1.4.1 (f)]	<input type="checkbox"/> Y <input type="checkbox"/> N
58. Instructions to be followed in event of emergency, delay, or if shipment is unclaimed. [7.1.4.1 (f)]	<input type="checkbox"/> Y <input type="checkbox"/> N
DANGEROUS WHEN WET (DIVISION 4.3) PRIMARY OR SUBSIDIARY RISK N/A	
For international shipments destined to the U.S., HAL at FedEx staffed facility unless limited quantity.	
59. U.S. domestic shipments (including Puerto Rico): DOT-SP/E approval number indicated on declaration and marked on package. Copy of DOT-SP/E letter provided. [FX-10]	<input type="checkbox"/> Y <input type="checkbox"/> N <input type="checkbox"/> N/A
60. U.S. domestic shipments (including Puerto Rico): Net quantity or gross weight (in metric units) as allowed per DOT-SP/E.	<input type="checkbox"/> Y <input type="checkbox"/> N <input type="checkbox"/> N/A
TOXICS (DIVISION 6.1) PRIMARY OR SUBSIDIARY RISK N/A	
61. International shipments: Packing Group I or II (except UN 1230, Methanol), package "V-rated." [FX-02]	<input type="checkbox"/> Y <input type="checkbox"/> N <input type="checkbox"/> N/A
62. U.S. domestic shipments (including Puerto Rico): Packing Group I or II (except UN1230, Methanol), DOT-SP/E approval number indicated on declaration and marked on package. Copy of DOT-SP/E letter provided. [FX-02]	<input type="checkbox"/> Y <input type="checkbox"/> N <input type="checkbox"/> N/A
63. U.S. domestic shipments (including Puerto Rico): Net quantity or gross weight (in metric units) as allowed per DOT-SP/E.	<input type="checkbox"/> Y <input type="checkbox"/> N <input type="checkbox"/> N/A
64. Not used.	
INFECTIOUS SUBSTANCES (DIVISION 6.2) N/A	
Labels may be reduced by 50%. [7.2.2.3.1]	
65. Name and telephone number of person responsible for shipment on declaration and package. [7.1.4.1 (e); 8.1.6.11.4]	<input type="checkbox"/> Y <input type="checkbox"/> N
66. "B" (package type code) Class 6.2" unless Overpacked. [6.5.3.1.2]	<input type="checkbox"/> Y <input type="checkbox"/> N
ALL PACKED IN ONE N/A	
67. Dangerous goods compatible. [5.0.2.11(b); Table 9.3.A; if to or from the U.S., must also comply with Title 49CFR 177.848]	<input type="checkbox"/> Y <input type="checkbox"/> N
68. "All Packed in One" and packaging type on declaration. [8.1.6.9.2, Step 6 (f)]	<input type="checkbox"/> Y <input type="checkbox"/> N
69. When required, "Q" value (to one decimal place) shown on declaration and does not exceed 1.0. See 2.7.5.6 (e) and 5.0.2.11 (h) for exceptions. [2.7.5.6 (f); 8.1.6.9.2 (g)]	<input type="checkbox"/> Y <input type="checkbox"/> N <input type="checkbox"/> N/A
OVERPACKS N/A	
70. Dangerous goods compatible. [5.0.1.5.1; Table 9.3.A; if to or from the U.S., must also comply with Title 49CFR 177.848]	<input type="checkbox"/> Y <input type="checkbox"/> N
71. "Overpack Used" on declaration. [8.1.6.9.2, Step 7]	<input type="checkbox"/> Y <input type="checkbox"/> N
72. "Overpack" on package when marking(s) and label(s) not visible. [7.1.7.1]	<input type="checkbox"/> Y <input type="checkbox"/> N
73. When different DG are packed in same Overpack and require multiple hazard labels, labels adjacent to each other (not opposite side). [7.2.6.2.4]	<input type="checkbox"/> Y <input type="checkbox"/> N <input type="checkbox"/> N/A
74. More than one Overpack used, unique identification mark (tracking number may be used) and total quantity of DG by UN # (including unit of measure) on both declaration and package. [7.1.7.2; Figure 8.1.L and 8.1.M]	<input type="checkbox"/> Y <input type="checkbox"/> N <input type="checkbox"/> N/A
STATE & OPERATOR VARIATIONS	
75. Complies with all other applicable State and Operator variations. [2.8] If USG-04, "RQ" is indicated before or after basic description on declaration when marked on the package; "RQ" is marked on package when on declaration.	<input type="checkbox"/> Y <input type="checkbox"/> N
If there are any discrepancies indicated, your shipment cannot be transported by FedEx Express. In the U.S., this shipment is returned to the Shipper using DOT-SP 14691. In the U.S., call 1.800.GoFedEx and press "81" for assistance. For non-U.S. locations, please contact your local Customer Service representative.	
Printed or other static representations of this document are considered uncontrolled and for reference only.	
<input type="checkbox"/> ACCEPTED <input type="checkbox"/> REJECTED	
Inspected By _____	
Employee# _____	
Shipper Contact Name _____	
Shipper Contact Phone# _____	

EFFECTIVE: 01/01/15 REVISION: 03/12/15
© 2015 FedEx Express. All rights reserved.

CHECKLIST 5. CATEGORY B GUIDANCE CHECKLIST

Category B material is characterized as UN 3373 Category B, Biological Substance.

Category B shipments must be triple packed in a rigid and sturdy package with appropriate and accompanying documentation. Category B shipments must be compliant in accordance with the applicable and current IATA Dangerous Goods Requirements following Packing Instruction 650, and the U.S. DOT Hazardous Material Regulations as listed in Title 49 of the CFR, Parts 100 – 185.

PRIMARY CONTAINER

- Contains appropriate specimen/material identifying information such as a patient identification number.
- Primary containers must be a securely sealed leak proof container. Leak proof = watertight and sealed, such as a screw cap receptacle and Parafilm. Primary containers can be glass, metal, or plastic.
Note: a Petri dish alone or with Parafilm is not an acceptable primary container for regulated shipping purposes because it does not form a leak proof and watertight seal.
- Wrapped in absorbent material sufficient for entire contents of hazardous material and type (liquid or solid).
- Wrapped in cushioning material as needed to provide structural integrity support. If multiple primary containers are included, individually wrap each one.
Note: Absorbent material can also be used as cushioning material.
- Primary **OR** secondary container must be pressure resistant (95kPa compatible).
Note: Multiple primary containers are permitted to be included inside a secondary container.

SECONDARY CONTAINER

- Secondary container is a securely sealed leak proof container. Leak proof = watertight and sealed.
- Primary **OR** secondary container pressure resistant (95kPa compatible).
- A biohazard symbol must be displayed on the outside of the secondary container.
- A completed itemized list of contents (i.e. test requisition or sample submission form) is placed between the secondary packaging and the outer packaging, NOT inside the secondary packaging container.
- Absorbent material is placed between the primary and secondary packaging.
- (Optional) Additional cushioning material placed between primary and secondary as needed.

OUTER PACKAGE

- Outer box not required to have UN certified package markings. Category B boxes must be rigid and sturdy material and pass appropriate packaging test requirements.
- Quantity of hazardous material must be listed on outside of box in volume (mL) or weight (g).
 - Cannot exceed 4L or 4kg if shipped in passenger or cargo aircraft.
 - *If dry ice is used*, the quantity of dry ice included must be listed on the outside package.
- Orientation marks (Up Arrows) on two opposite sides of the outer packaging if shipping liquids greater than 50mL.
- Full name, complete address and phone number of the **Responsible Person** for the shipment.
 - (This can be either the shipper or the recipient, but must be someone knowledgeable of the contents).
- Full name, complete address and telephone number of the **shipper**.
- Full name, complete address and telephone number of the **consignee/recipient**.
- Marked with the appropriate UN identification number and proper shipping name as characterized:
 - UN 3373 Biological Substance
- Include any permits that may be required.

CHECKLIST 6. DRY ICE GUIDANCE CHECKLIST

Dry ice is a Class 9 Miscellaneous Dangerous Good. Shipments containing dry ice must have an outer packaging able to allow the release of carbon dioxide gas as the dry ice sublimates. Depending on the packaging materials used, dry ice may surround a secondary container within an outer/tertiary container, or dry ice may surround a completed outer package, inside an overpack container. Dry ice must not be placed in a sealed container.

The total quantity of dry ice included must always be listed on the outer packaging. If a Shipper's Declaration for Dangerous Goods form is required (e.g., when shipping a Category A material), dry ice and its quantity must be listed. Packages containing dry ice must conform to Packing Instruction (PI) 954, and display the UN1845 hazard identification marking.

When dry ice is included with a Category A shipment, the dry ice must be listed on the required Shipper's Declaration for Dangerous Goods form. When dry ice is included with a Category B or Exempt Specimen shipment, a Shipper's Declaration for Dangerous Goods form is not required.

OUTER PACKAGE

- Properly ventilated outer package to allow release of gases as dry ice sublimates during transport
 - Note:** Dry ice must **not** be placed in a tightly sealed or completely taped container
 - Note:** UN certified package symbol must be present on an outer Category A package. UN certified package symbol is not required on outer Category B shipment
- If overpack is used, overpack label must be displayed on outside packaging
- The net quantity of dry ice included must be listed on outside package (i.e., 3 kg)
- The net quantity of included dry ice per package must be less than 200kg
- Irrelevant marks and labels must be removed from package
- Must display the UN hazard identification number UN 1845
- Miscellaneous Hazard Class 9 label or sticker
- Full name, complete address and telephone number of the shipper
- Full name, complete address and telephone number of the consignee/recipient
- Full name and phone number of person responsible for the shipment
 - Note:** Responsible person can be either the shipper or the recipient, but must be someone knowledgeable of the contents

SHIPPER'S DECLARATION WITH DRY ICE

A Shipper's Declaration for Dangerous Goods must be completed for shipments containing Category A infectious substances. If dry ice is included with a Category A shipment, the Shipper's Declaration must list:

- The words "Carbon dioxide, solid" or "Dry ice" in the Proper Shipping Name column
- Class 9 in the Class or Division column
- Packing Instruction 954 in the Packing Instruction column
- The included quantity in weight (i.e., 3 kg) in the Quantity and Type of Packaging column

Note: Packing Group III no longer needs to be listed for dry ice

Consult the Shipper's Declaration checklist for complete list of items



CHECKLIST 7. OVERPACK GUIDANCE CHECKLIST

OVERPACK OUTER PACKAGE

Overpack will include a fully complete and labeled inner package or packages. Overpack is commonly used with shipments containing dry ice, and can also be used to consolidate multiple completed packages into one larger container in order to: (1) reduce shipping costs by consolidation, (2) ship more than one class of hazardous material together, and/or (3) ship different temperature packages together.

- Inner packages are each individually wrapped and properly packed and labeled within the outer overpack
- Outermost packaging must be labeled with the highest hazard level of the inner contents
- Proper shipping name and the UN identification number

Examples:

- UN 3373 Biological Substances, Category B
- UN 2814 Suspected Category A Infectious Substance, Affecting Humans
- UN 2814 Infectious Substances, Affecting Humans

NOTE: Special Provision A140 states: technical name can be omitted on outer package due to security purposes, however, technical name must appear on Shipper's Declaration if required

- Full name, complete address and phone number of person responsible for the shipment (This can be either the shipper or the recipient, but must be someone knowledgeable of the contents)
- Full name, complete address and telephone number of the shipper
- Full name, complete address and telephone number of the consignee/recipient
- Class 6 diamond shape label for Category A material and/or UN3373, Biological Substance label for Category B material
- Must be marked "Overpack"
- "Inner packages comply with prescribed specifications" label or sticker
- Orientation marks are on two opposing sides if containing liquids
- Quantity of total included hazardous contents is listed on outer packaging

IF PACKAGE CONTAINS DRY ICE, INCLUDE:

- Class 9 Miscellaneous Hazard label
- The words "Carbon dioxide, solid" or "Dry Ice" in the Proper Shipping Name Column and UN1845
- The included quantity in weight (e.g, 3kg) in the Quantity and Type of Packaging Column

Consult Dry Ice Checklist for additional items

CHECKLIST 8. EXEMPT SPECIMEN GUIDANCE CHECKLIST

Exempt Human Specimen and Exempt Animal Specimen shipments are not regulated under the DOT Hazardous Material Regulations for ground transport, but must still be triple packaged. Exempt Human and Animal Specimens are regulated under the IATA Dangerous Goods Regulations for air transport and must be labeled and triple packaged.

Answer the questions below to determine if your shipment is classified as exempt:

YES NO

- Is it known NOT to contain an infectious substance?
 - Are the microorganisms present non-pathogenic to humans and animals?
 - Have the pathogens present been neutralized or inactivated so they no longer pose a health risk?
 - Is it an environmental sample (e.g., food or water) that is not considered to pose a significant health risk?
 - Is it a biological product or a biological material (e.g., blood product, tissue, or organ) subject to U.S. Department of Health and Human Services or U.S. Department of Agriculture regulation?
 - Is it a dried bloodspot or fecal occult blood?
 - Is it laundry, medical equipment or a used health care product that conforms to 29 CFR 1910.1030?
 - Is it forensic material that complies with U.S., state, local, or Indian tribal government regulations?
 - Is it an agricultural product or food defined under the federal Food, Drug, and Cosmetics Act?
 - Is it intended for transplant or transfusion?
 - Is it a patient specimen that is unlikely to cause disease in humans or animals or for which there is only a minimal likelihood that pathogens are present?
-

- If you were able to answer **YES** to ANY of the above questions, and your shipment does not contain an infectious substance, then it is not subject to the 6.2 regulations.

- If you answered **NO** to ALL of the above questions, then you must conform to the Division 6.2 requirements and proceed to classify the shipment as either;
 - Category A
 - Category B
- A complete listing of materials excepted from regulation as Division 6.2 materials under the HMR is found in 49 CFR §173.134



CATEGORY A LIST VS. SELECT AGENT LIST COMPARISON JOB AID

Category A Infectious Substance List vs. Select Agent List Comparison

The list of Select Biological Agents and Toxins closely resembles the Category A indicative list of organisms, although the overlap is not identical. There are some key differences between the lists, and both lists should be consulted for Category A shipping purposes. Sample classification for inclusion as a Category A shipment should take into account the organisms on the Health and Human Services (HHS) / U.S. Department of Agriculture (USDA) Select Agent list. Confirmed select agents must always be shipped as Category A, and potential or suspect select agents as "Suspected Category A". The HHS/USDA Select Biological Agent and Toxin list can be found here:

<http://www.selectagents.gov/SelectAgentsandToxinsList.html>

KEY DIFFERENCES BETWEEN THE LISTS:

1. The Category A and Select Agent lists are not identical.
2. Select Agent list is a complete list of regulated organisms and toxins.
3. Category A list is an indicative example list, and not considered to be all-inclusive.
4. Select agent list does not have the word "culture" after any names of organisms or toxins.
5. Category A list has the word "culture" only after some of the listed organisms, indicating that specific organism is only required to be classified as Category A when shipped in culture form.
6. Select Agent list is comprised of infectious microorganisms and toxins.
7. Category A list is comprised only of infectious microorganisms. Organisms that produce and that may contain a toxin are classified as Division 6.2 material and shipped as infectious material. If a purified or isolated toxin is shipped it is classified as Division 6.1 material.

The following organisms and toxins appear on the Select Agent list, but currently not on the Category A list:

- Abrin
- African horse sickness virus
- Avian influenza virus³
- Botulinum neurotoxins*
- Conotoxins (Short, paralytic alpha conotoxins containing the following amino acid sequence X₁CCX₂PACGX₃X₄X₅X₆CX₇)¹
- Diacetoxyscirpenol
- Lujo virus
- *Mycoplasma capricolum*³
- Newcastle disease virus^{2,3}
- *Peronosclerospora philippinensis* (*Peronosclerospora sacchari*)
- *Phoma glycinicola* (formerly *Pyrenochaeta glycines*)
- *Ralstonia solanacearum*
- *Rathayibacter toxicus*
- Reconstructed replication competent forms of the 1918 pandemic influenza virus containing any portion of the coding regions of all eight gene segments (Reconstructed 1918 Influenza virus)
- Ricin
- *Rickettsia prowazekii*
- SARS-associated coronavirus (SARS-CoV)

- Saxitoxin
- *Sclerophthora rayssiae*
- South American Haemorrhagic Fever virus (Chapare)
- Staphylococcal enterotoxins A,B,C,D,E subtypes
- *Synchytrium endobioticum*
- T-2 toxin
- Tetrodotoxin
- Variola major virus (Smallpox virus)*
- Variola minor virus (Alastrim)*
- *Xanthomonas oryzae*

LEGEND:

*Denotes Tier 1 Agent

¹ C = Cysteine residues are all present as disulfides, with the 1st and 3rd Cysteine, and the 2nd and 4th Cysteine forming specific disulfide bridges; The consensus sequence includes known toxins α -MI and α -GI (shown above) as well as α -GIA, Ac1.1a, α -CnIA, α -CnIB; X1 = any amino acid(s) or Des-X; X2 = Asparagine or Histidine; P = Proline; A = Alanine; G = Glycine; X3 = Arginine or Lysine; X4 = Asparagine, Histidine, Lysine, Arginine, Tyrosine, Phenylalanine or Tryptophan; X5 = Tyrosine, Phenylalanine, or Tryptophan; X6 = Serine, Threonine, Glutamate, Aspartate, Glutamine, or Asparagine; X7 = Any amino acid(s) or Des X and; "Des X" = "an amino acid does not have to be present at this position." For example if a peptide sequence were XCCHPA then the related peptide CCHPA would be designated as Des-X.

² A virulent Newcastle disease virus (avian paramyxovirus serotype 1) has an intracerebral pathogenicity index in day-old chicks (*Gallus gallus*) of 0.7 or greater or has an amino acid sequence at the fusion (F) protein cleavage site that is consistent with virulent strains of Newcastle disease virus. A failure to detect a cleavage site that is consistent with virulent strains does not confirm the absence of a virulent virus.

³ Select agents that meet any of the following criteria are excluded from the requirements of this part: Any low pathogenic strains of avian influenza virus, South American genotype of eastern equine encephalitis virus, west African clade of Monkeypox viruses, any strain of Newcastle disease virus which does not meet the criteria for virulent Newcastle disease virus, all subspecies *Mycoplasma capricolum* except subspecies *capripneumoniae* (contagious caprine pleuropneumonia), all subspecies *Mycoplasma mycoides* except subspecies *mycoides* small colony (Mmm SC) (contagious bovine pleuropneumonia), and any subtypes of Venezuelan equine encephalitis virus except for Subtypes IAB or IC, provided that the individual or entity can verify that the agent is within the exclusion category (Revised 9/10/13).

Select Agent website: www.selectagents.gov

The website is the resource for forms, guidance, regulations, list of select agents and toxins, including Tier 1 designations. Always download the forms directly from the website to ensure use of current version. All questions or concerns should be coordinated with the LRN Reference Laboratory and State Health Department.

The following organisms appear on the Category A list, but currently not on the Select Agent list:

- *Chlamydia psittaci* (avian) (cultures only)
- Classical swine fever virus (cultures only)
- *Coccidioides immitis* (cultures only)
- Dengue virus (cultures only)
- *Escherichia coli*, verotoxigenic (cultures only)
- Hantavirus causing hemorrhagic fever with renal syndrome
- Hantaan virus
- Hepatitis B virus (cultures only)
- Herpes B virus (cultures only)
- Human immunodeficiency virus (cultures only)
- *Mycobacterium tuberculosis* (cultures only)
- Poliovirus virus (cultures only)
- Rabies virus (cultures only)
- *Rickettsia rickettsii* (cultures only)
- *Shigella dysenteriae* type 1 (cultures only)
- Venezuelan equine encephalitis virus (cultures only)
- Vesicular stomatitis virus (cultures only)
- West Nile virus (cultures only)
- Yellow fever virus (cultures only)

Always refer to public health authorities (e.g., CDC, WHO, or other state or local public health agencies) for guidance when transporting a new or emerging pathogen or when there is a transporting concern.



APPENDIX

<i>Bacillus anthracis</i> Characteristics Chart.....	269
<i>Brucella</i> spp. Identification Flowchart.....	271
<i>Brucella</i> spp. Characteristics Chart.....	272
<i>Burkholderia mallei</i> Identification Flowchart.....	273
<i>Burkholderia mallei</i> Characteristics Chart.....	274
<i>Burkholderia pseudomallei</i> Identification Flowchart.....	275
<i>Burkholderia pseudomallei</i> Characteristics Chart.....	276
<i>Francisella tularensis</i> Presumptive ID Chart.....	277
<i>Francisella tularensis</i> Identification Flowchart.....	278
<i>Francisella tularensis</i> Characteristics Chart.....	279
<i>Yersinia pestis</i> Identification Flowchart.....	280
<i>Yersinia pestis</i> Characteristics Chart.....	281
<i>Yersinia pestis</i> Differentiation Chart.....	282
Decontamination of Select Agents Isolated in the Clinical Laboratory.....	283
APHIS/CDC Select Agent Form 2 Checklist.....	284
APHIS/CDC Select Agent Form 3 Checklist.....	286
APHIS/CDC Select Agent Form 4 Checklist.....	289
Select Agent Algorithm Guide.....	292
What to Do When a Select Agent is Suspected in Your Lab.....	293
OSHA Poster 2015.....	294
Category A vs. Select Agent List Comparison.....	295
NLTN Biosafety Checklist for Clinical Laboratories* Biosafety Level 2.....	298
NLTN Biosafety Checklist for Clinical Laboratories* Biosafety Level 3.....	308
Job Hazard Analysis Chart Job Aid.....	321
Job Hazard Analysis Examples Job Aid.....	322
APHL ID Biosafety Checklist 2015.....	323
Transporting Infectious Substances Safely.....	324
Sentinel Laboratory Biochemical Reference Chart.....	325
Tests to Differentiate Organisms Similar to the Bioterrorism Agents.....	327

Bacillus anthracis Identification Flowchart

SAFETY: As soon as *B. anthracis* is suspected, perform ALL further work in a Class II BSC using BSL-3 practices.

Major characteristics of *Bacillus anthracis*:
Gram stain morphology: Large, Gram positive rods. Spores may be found in cultures grown in 5% CO₂ but not usually in clinical samples
Colony morphology: Ground glass appearance, non-pigmented, gamma hemolytic (no hemolysis) on BAP,
No growth on MAC (or EMB)

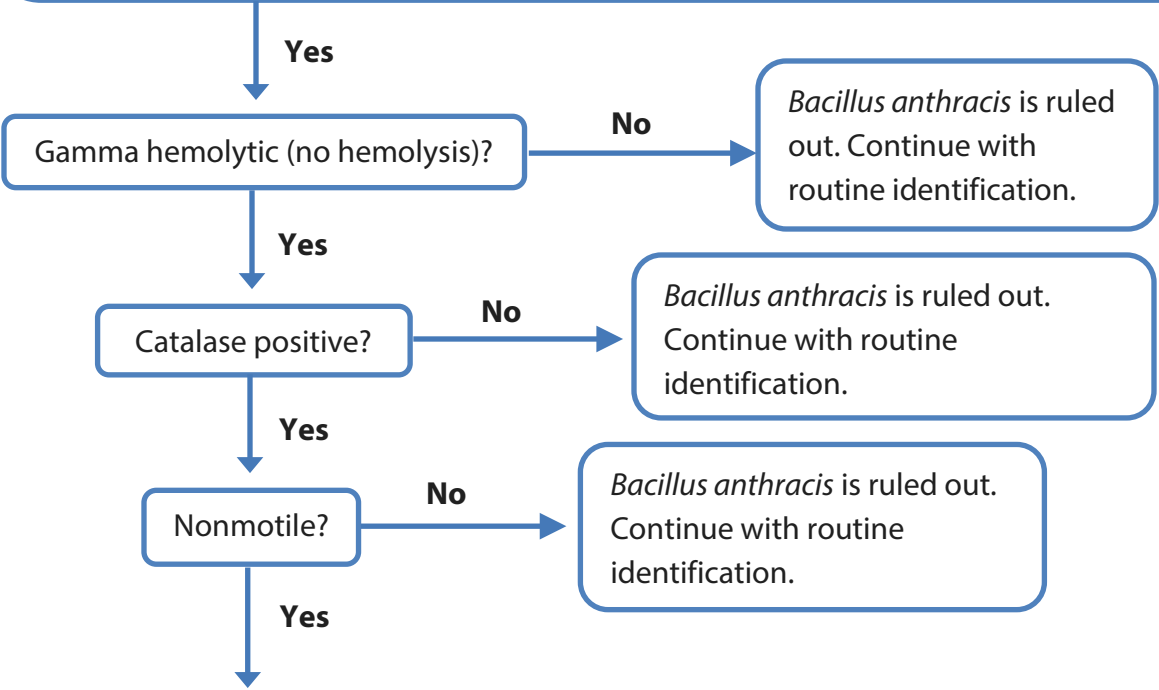

Bacillus anthracis is not ruled out.
Contact your LRN Reference Level Laboratory to refer isolate.
Report: Possible *Bacillus anthracis* submitted to LRN Reference Laboratory

ASM, 3/30/16



Bacillus anthracis CHARACTERISTICS CHART

GRAM STAIN:

- Large Gram positive rod (1-1.5 x 3-5µm)
- Central to subterminal spores
- Single, short chains, or long chains

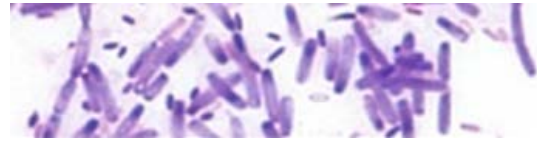

COLONY MORPHOLOGY:

- Grey, ground-glass appearance
- Irregular borders on Sheep Blood agar; "Medusa head", "comet tail", or "comma-shaped projections"
- Tenacious consistency; stands up when teased with a loop
- Flat or slightly convex
- Gamma hemolytic (no hemolysis) on BAP

GROWTH:

- Rapid on Sheep Blood agar (growth in 6-8 h, individual colonies 12-15 h)
- No growth on MacConkey or Eosin Methylene Blue agars

BIOCHEMICALS:

- Catalase - Positive
- Motility - Nonmotile



**Refer Cultures to your
LRN Reference Laboratory**

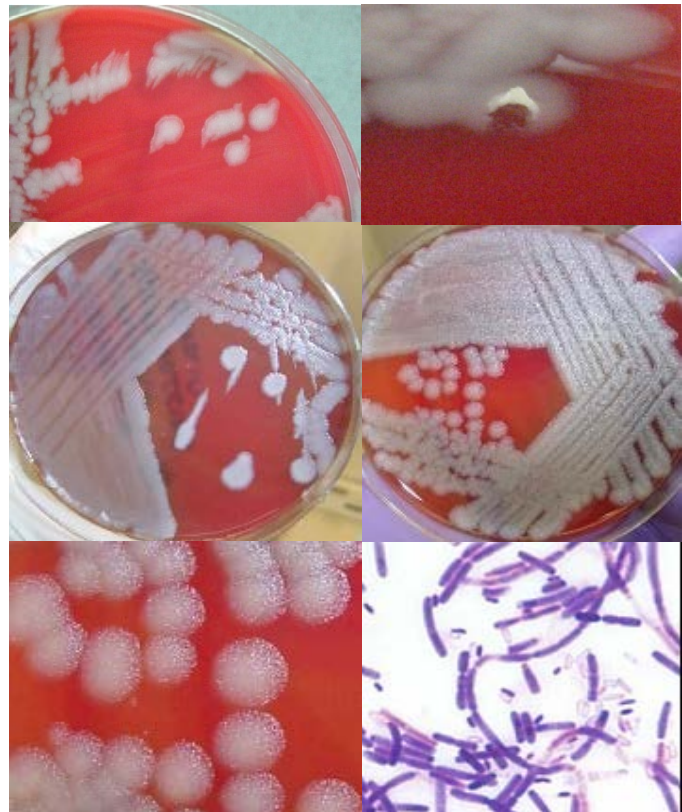

Brucella spp. IDENTIFICATION FLOWCHART

SAFETY: As soon as *Brucella* is suspected, perform ALL further work in a Class II BSC using BSL-3 practices.

Major characteristics of *Brucella* species:

Gram stain morphology: Small (0.4 x 0.8µm), Gram negative coccobacillus
THINK BRUCELLA

Growth: Subculture positive aerobic blood culture to BAP, CHOC. Incubate in 5-10% CO₂ at 35°C, Spot BAP with *S. aureus* ATCC 25923 for satellite test. Note poorly growing colonies after 24 hour incubation on BAP and CHOC.

Incubate plates for at least two additional days if no growth in 24 hours.
Organism does NOT grow on MAC/EMB. (Pinpoint colonies infrequently after extended Incubation; 7 days)

Is the organism only growing on BAP without the need to satellite around the *S. aureus* at 24-48 hours?

No

Consider *Haemophilus*

Yes

Oxidase positive and catalase positive?

No

Think *Francisella* (see procedure)

Yes

Urea positive?

No

Reincubate and see written procedure

Yes

Brucella not ruled out.

Contact LRN Reference Level Laboratory to refer the isolate.

Report: Possible *Brucella* species submitted to LRN Reference Laboratory.
Antimicrobial therapy: Rifampin or Streptomycin plus Doxycycline

ASM, 3/30/16

Brucella spp. CHARACTERISTICS CHART

GRAM STAIN:

- Small, faintly-staining Gram negative coccobacilli (0.4 x 0.8µm)

COLONY MORPHOLOGY:

- Light “dust” of growth after 24 h
- Punctate on Sheep Blood agar at 48 h
- Smooth, convex, and raised with an entire edge on Chocolate and Sheep Blood agar after 48 h
- Non-pigmented; non-hemolytic

GROWTH:

- Slow upon primary isolation; most require CO₂ incubation
- No growth on MacConkey or Eosin Methylene Blue agar (infrequently, pinpoint colonies on MacConkey after extended incubation – 7 days)
- Does not satellite around *S. aureus* (does not require X & V factors)

BIOCHEMICALS:

- Oxidase, catalase, and urease positive



**Refer Cultures to your
LRN Reference Laboratory**

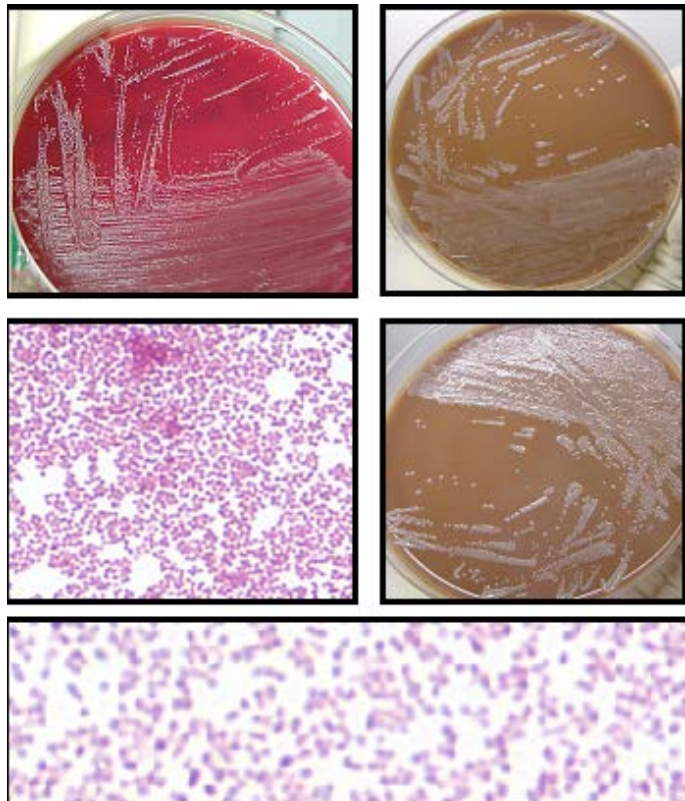

Burkholderia mallei IDENTIFICATION FLOWCHART

SAFETY: As soon as *Burkholderia* is suspected, perform ALL further work in a Class II BSC using BSL-3 practices.

Major characteristics of *Burkholderia mallei*:

Gram stain morphology: Gram negative coccobacilli or small rods

Colony morphology: Poor growth at 24 h; better growth of gray, translucent colonies without pigment or hemolysis at 48 h on BAP; poor or no growth on MAC/EMB in 48 h; no distinctive odor

Reactions: Oxidase-variable; indole negative; catalase positive

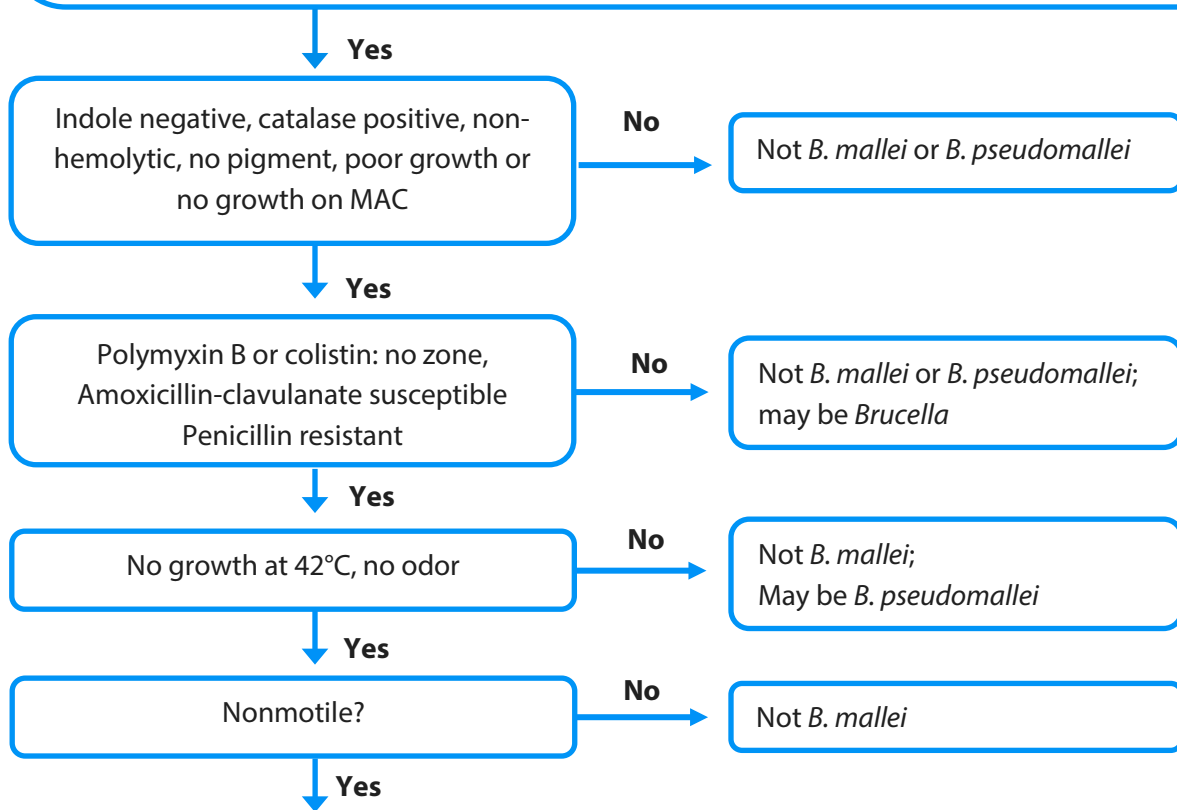

B. mallei not ruled out.

Contact your LRN Reference Level Laboratory to refer isolate.

Report: Possible *Burkholderia mallei* submitted to LRN Reference Level Laboratory.

Additional screening test: *B. mallei* and *B. pseudomallei* are Arginine positive, unlike many other *Burkholderia* spp. (Test can be observed in kit identification systems.)

Burkholderia mallei CHARACTERISTICS CHART

GRAM STAIN:

- Small Gram negative coccobacilli or small rods

COLONY MORPHOLOGY:

- Smooth, gray, translucent on Sheep Blood agar after 48h
- Light pink on MacConkey or Eosin Methylene Blue agar after 72h

GROWTH:

- No growth at 42 °C at 48h
- Variable on MAC/EMB agar
- Resistant to colistin and polymyxin B
- Resistant to penicillin
- Susceptible to amoxicillin/clavulanic acid
- No pigment on MH agar

BIOCHEMICALS:

- Oxidase variable
- Indole negative
- Glucose non-fermenter
- Catalase positive
- Arginine dihydrolase positive

MOTILITY:

- Nonmotile



**Refer Cultures to your
LRN Reference Laboratory**

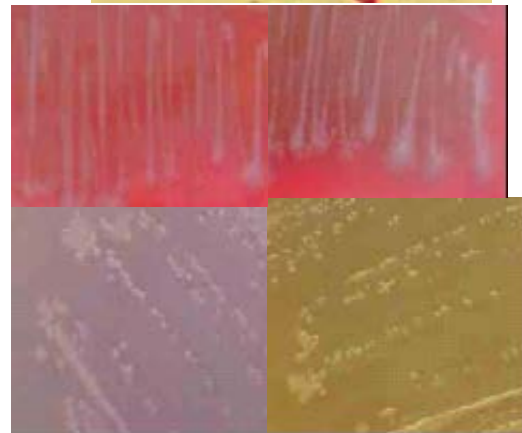
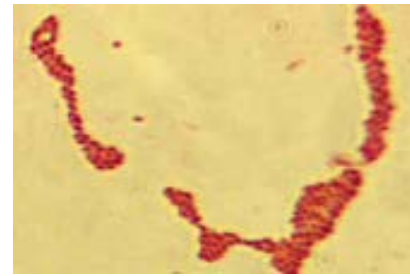

Burkholderia pseudomallei IDENTIFICATION FLOWCHART

SAFETY: As soon as *Burkholderia* is suspected, perform ALL further work in a Class II BSC using BSL-3 practices.

Major characteristics of *Burkholderia pseudomallei*:

Gram stain morphology: Gram negative rod, straight or slightly curved, may demonstrate bipolar morphology at 24 h and peripheral staining, like endospores, as cultures age

Colony morphology: Poor growth at 24 h, good growth of smooth, creamy colonies at 48 h on BAP; may develop wrinkled colonies in time, nonhemolytic. Can demonstrate strong characteristic musty, earthy odor; growth on MAC/EMB in 48 h, no pigment is visible on Mueller-Hinton agar, may have non-violet pigment on BAP.

Reactions: Oxidase positive; indole negative

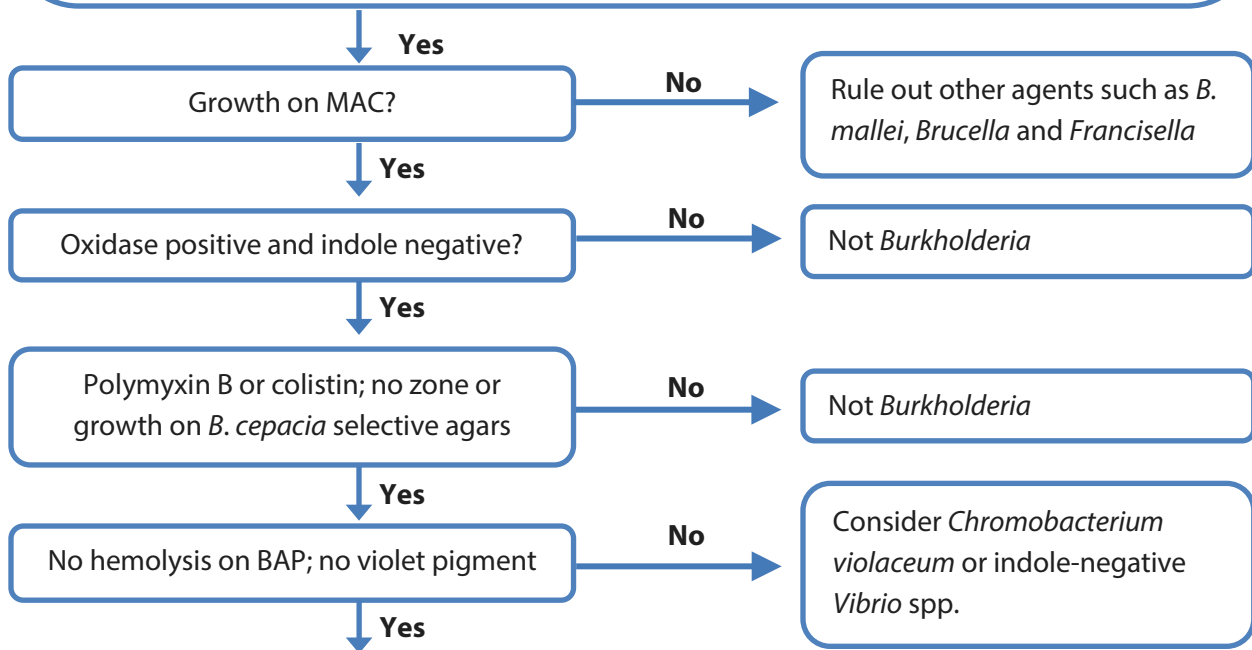

B. pseudomallei not ruled out, especially if colonies have musty odor.
B. pseudomallei is separated from *B. cepacia* by a susceptible amoxicillin-clavulanate test.
Although rare in *B. pseudomallei*, resistance cannot rule out the identification.
Contact your LRN Reference Level Laboratory to refer isolate.

Report: Possible *Burkholderia pseudomallei* submitted to LRN Reference Laboratory.
Additional screening test: *B. pseudomallei* and *B. mallei* are arginine positive, unlike other *Burkholderia*. (Test can be in kit identification systems.)
Unlike *B. mallei*, *B. pseudomallei* grows at 42°C in 48 h and is motile.

Burkholderia pseudomallei CHARACTERISTICS CHART

GRAM STAIN:

- Small, straight, or slightly curved Gram negative rods (1-3 x <2.0µm)
- Smooth form arranged in long, parallel bundles
- Rough form arranged irregularly
- Bipolar staining

COLONY MORPHOLOGY:

- Smooth, creamy on Sheep Blood and CHOC agar at 24 h; may display metallic sheen on BAP, CHOC at 48 h; some become either mucoid or dry and wrinkled after 48-72 h; no violet pigment
- Pink on MAC/EMB agar at 24-48 h; will become dry and wrinkled after 48-72 h

GROWTH:

- Heavy at 42 °C at 48 h
- Resistant to colistin and polymyxin B
- Resistant to penicillin
- Susceptible to amoxicillin/clavulanic acid
- No pigment on MH agar
- Distinctive musty or earthy odor

BIOCHEMICALS:

- Oxidase, catalase, and arginine dihydrolase positive
- Indole negative
- Glucose non-fermenter

MOTILITY:

- Motile



Refer Cultures to your LRN Reference Laboratory

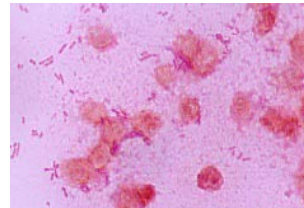

Francisella tularensis PRESUMPTIVE ID CHART

PRESUMPTIVE ID CHART FOR *Francisella tularensis*^a

Tests	<i>Brucella</i> spp.	<i>Francisella tularensis</i>	<i>Psychrobacter phenylpyruvicus</i>	<i>Oligella ureolytic</i> ^a	<i>Haemophilus</i> spp. ^b
Gram stain morphology	tiny ccb, stains faintly	Tiny ccb, stains faint	ccb, rods, retains crystal violet	tiny ccb	Tiny ccb
Catalase	+	-, or weakly +	+	+	v
Oxidase	+	-	+	+	v
Motility	-	-	-	+,delayed	-
BAP distinctions	-	+ (scant growth)	-	-	No growth ^b
MAC-48 h	-	-	-	-	-

^a Reactions extracted from ASM Sentinel Protocols for *Brucella* spp. and *F. tularensis*

NA, not applicable

v, variable

ccb, coccobacilli

O. ureolytica is primarily a uropathogen

^b Only grows on CHOC (requires X & V); or on BAP associated with *S. aureus* colony (satellite test).

Francisella tularensis IDENTIFICATION FLOWCHART

SAFETY: As soon as *Francisella* is suspected, perform ALL further work in a Class II BSC using BSL-3 practices.

Major characteristics of *Francisella tularensis*

Gram stain morphology: Pleomorphic, minute (0.2 to 0.5 by 0.7 to 1.0 μm) faintly staining, Gram negative coccobacillus

Colony morphology: No growth on MAC/EMB, scant to no growth on BAP after > 48 h. Produces 1-2 mm gray to grayish-white colonies on CHOC after > 48 h

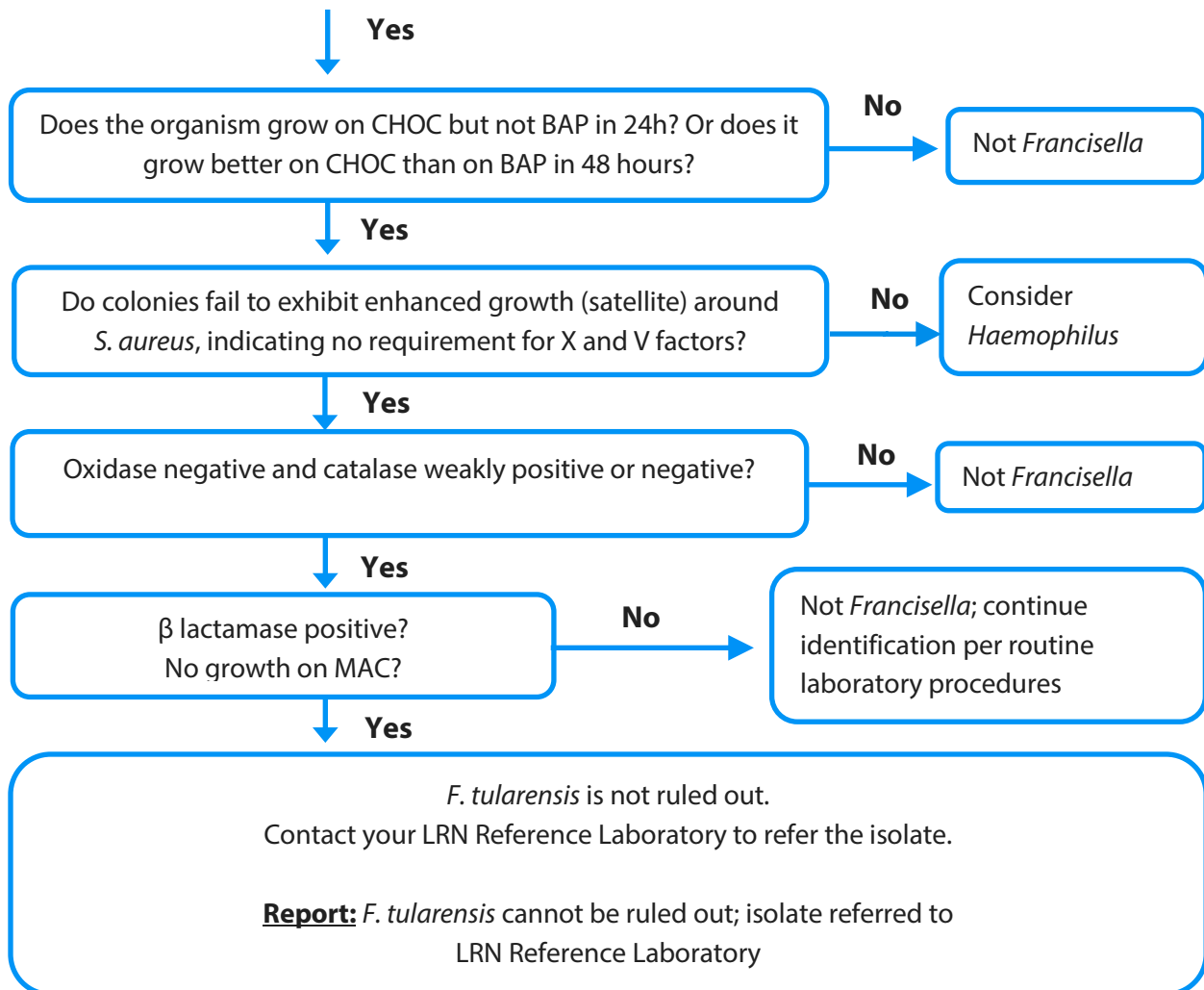

ASM, 3/30/16

WARNING: Automated identification systems may key out as non-*F. tularensis* (e.g. *Haemophilus influenzae* and *Aggregatibacter*)

Francisella tularensis CHARACTERISTICS CHART

GRAM STAIN:

- Faintly-staining, tiny, pleomorphic, Gram negative coccobacilli
- Mostly single cells (0.2-0.5 x 0.7-1.0µm)

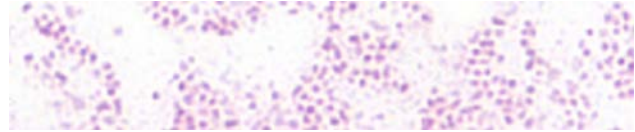

COLONY MORPHOLOGY:

- Smooth, shiny, and butyrous
- Tiny, grey-white, and opaque on Sheep Blood agar, Chocolate agar, Thayer-Martin agar, and BCYE agar

GROWTH:

- Usually too small to be seen at 24 h
- Requires cysteine supplementation
- Scant to no growth on Sheep Blood agar after 48 h
- Grows better on Chocolate agar
- No growth on MacConkey or Eosin Methylene Blue agar
- Slow growth in broth

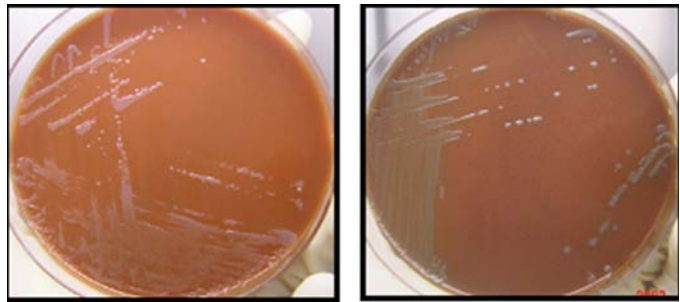

BIOCHEMICALS:

- Oxidase and satellite (or XV) negative
- Catalase negative or weakly positive
- Beta-lactamase positive

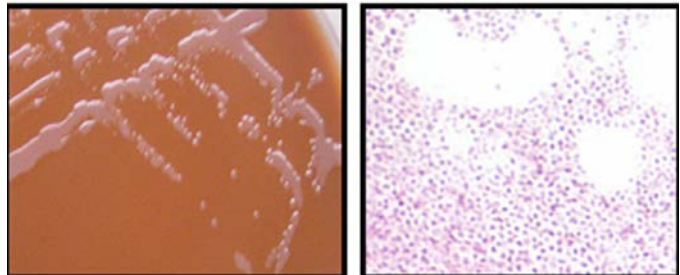

**Refer Cultures to your
LRN Reference Laboratory**

Yersinia pestis IDENTIFICATION FLOWCHART

SAFETY: As soon as *Yersinia pestis* is suspected, perform ALL further work in a Class II BSC using BSL-3 practices.

Major characteristics of *Yersinia pestis*:

Gram stain morphology: Gram negative rods, 0.5 x 1-2 μm

Colony morphology: Slow growing at 35°C with either pinpoint colonies or no growth on BAP after 24 h; colonies are 1-2 mm, gray-white to slightly yellow and opaque on BAP after 48 h; non-lactose fermenter on MAC/EMB;

Specimen is blood, sputum, or lymph node aspirate

Yes

Oxidase: Negative
Catalase: Positive
Indole: Negative
Urease: Negative

No

Not *Yersinia pestis*.
Continue identification per routine laboratory procedures.
May be other *Yersinia* spp.

Yes

Y. pestis is not ruled out.

Contact LRN Reference Level Laboratory to refer the isolate.

Report: *Y. pestis* cannot be ruled out; isolate referred to LRN Reference Laboratory.

WARNING: Some of the automated identification systems do not identify *Y. pestis* adequately. *Y. pestis* has been falsely identified as *Y. pseudotuberculosis*, *Shigella*, H₂S negative *Salmonella*, *Acinetobacter*, and *Pseudomonas* species.

Yersinia pestis CHARACTERISTICS CHART

GRAM STAIN:

- Plump, Gram negative rods (1.0-2µm x 0.5µm)
- Variable bipolar staining seen with Giemsa or Wright stain
- Single cells or pairs and short chains

COLONY MORPHOLOGY:

- BAP: Slow growing at 35°C with either pinpoint colonies or no growth after 24 h; colonies are 1-2 mm, gray-white to slightly yellow and opaque after 48 h.
- MAC/EMB: Non-lactose fermenter
- May have a raised, irregular “fried egg” appearance after 48-72 h. (This is not unique to *Y. pestis* but can be a useful characteristic, if observed.)

GROWTH:

- Grows at both 25-28°C (optimal) and 35-37°C

BIOCHEMICALS:

- Oxidase, urease, and indole negative
- Catalase positive



**Refer Cultures to your
LRN Reference Laboratory**

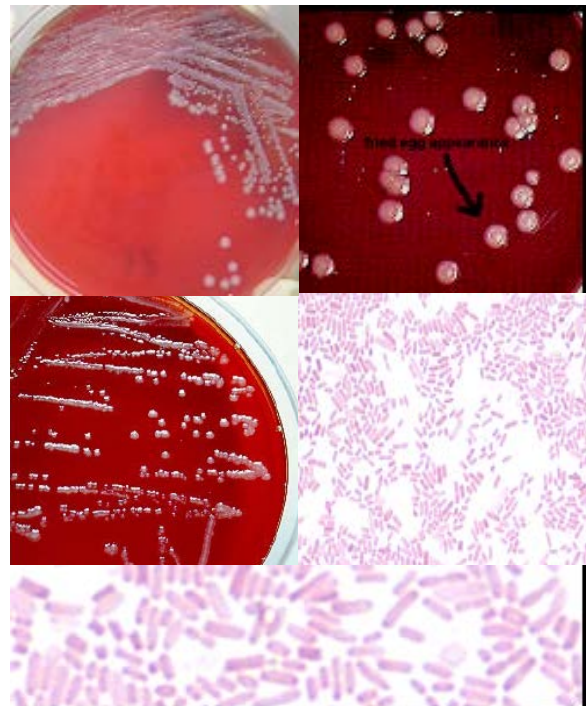

Yersinia pestis DIFFERENTIATION CHART

DIFFERENTIATION OF *Y. pestis* FROM OTHER ORGANISMS BY CONVENTIONAL MICROBIOLOGY PROCEDURES

Organism	Gram Stain	Growth on BAP	Growth on MacConkey	Oxidase	Catalase	Urease
<i>Yersinia pestis</i>	Gram negative	Slow	Non-Lactose Fermenter	Negative	Positive	Negative
<i>Yersinia pseudotuberculosis</i>	Gram negative	Slow	Non-Lactose Fermenter	Negative	Positive	Positive
<i>Yersinia enterocolitica</i>	Gram negative	Slow	Non-Lactose Fermenter	Negative	Positive	Positive
<i>Escherichia coli</i>	Gram negative	Good	Lactose Fermenter	Negative	Positive	Negative
<i>Klebsiella pneumoniae</i>	Gram negative	Very good, 2-4 mm colonies 24 h	Lactose Fermenter	Negative	Positive	Positive/Negative
<i>Enterobacter cloacae</i>	Gram negative	Good	Lactose Fermenter	Negative	Positive	Variable
<i>Pasteurella multocida</i>	Gram negative	Good	Variable	Positive	Positive	Negative

DECONTAMINATION OF SELECT AGENTS ISOLATED IN THE CLINICAL LABORATORY

Select agents (www.selectagents.gov) cannot be directly discarded into the biohazardous waste stream like other regulated infectious medical waste materials. Select Agent regulations detailed in 7 CFR 331, 9 CFR 121 and 42 CFR 73 dictate that select agents may only be held no more than 7 days from confirmation by facilities that are registered and approved by CDC and/or USDA to possess those specific select agents. Once an isolate from a patient specimen in the clinical lab has been confirmed by the local Laboratory Response Network (LRN) Reference Laboratory as a select agent, the non-registered clinical lab must **destroy** all relevant patient specimens and cultures remaining in their possession, **or transfer** them to the nearest LRN Reference Laboratory that is registered for those select agents.

If a clinical lab decides to **destroy the patient specimens and cultures**, inactivation using an on-site autoclave or chemical decontamination must be performed before transport to a medical waste contractor for destruction and disposal.

Chemical Decontamination Process

1. Prepare a fresh 1:10 household bleach* solution in a receptacle large enough to submerge all containers/plates containing select agents.
2. Working in a BSC, completely immerse open culture containers in the bleach solution and leave containers in bleach solution overnight.
3. Once overnight inactivation is complete, turn the sink faucet on and discard the bleach solution down the drain with running tap water.
4. Package the inactivated culture plates and containers with other biohazardous waste that is transported off site by a medical waste management contractor for final treatment and disposal.

If a clinical lab chooses to **transfer the relevant specimens and cultures**, lab personnel will need to work with the LRN Reference Laboratory to ensure that the proper paperwork and transfer protocols are followed in compliance with all applicable local, state, and federal shipping regulations.

Note: If an organism is subcultured from a blood culture bottle and a LRN Reference Laboratory confirms the organism as a select agent or the patient is diagnosed with smallpox or a VHF, the blood culture bottles and any additional bottles that would contain the organism, must be decontaminated before transport off site. The contents in these bottles cannot be adequately decontaminated using chemical decontamination and must be autoclaved on site. If the facility does not have an autoclave on site, all positive blood culture bottles must be transferred to the closest LRN Reference Laboratory registered and approved to accept the select agent.

APHIS/CDC SELECT AGENT FORM 2 CHECKLIST

KEY POINTS:

- Clinical/diagnostic laboratories that want to transfer select agents and toxins after identification should first contact the recipient laboratory to see if they are willing and able to receive the select agent or toxin.
- The process must be coordinated between sender and requester/recipient.

SECTION 1:

- Form 2 is initiated by the recipient of the select agent or toxin.
- The recipient's Responsible Official (RO) should submit completed Form 2 to APHIS/CDC. It must be authorized by APHIS/CDC prior to the transfer.
- Request will not be processed if there is incomplete, illegible, or insufficient information. APHIS/CDC will contact the recipient laboratory to obtain necessary information.
- The approved transfer has to be completed within 30 calendar days from APHIS/CDC authorization.
- **Note:** Unregistered diagnostic/clinical laboratories must transfer or destroy the select agent or toxin within 7 days. Thirty days does not apply to unregistered entities.

SECTION 2:

- Completed by the shipper. Diagnostic/clinical laboratories must complete this section if shipping samples to their LRN reference laboratory or CDC.

SECTION 3:

- Upon receipt, the recipient RO will complete and sign section 3.
- Recipient RO will send 1 copy of completed APHIS/CDC Form 2 to the sender and APHIS/CDC within 2 business days of receipt of the shipment.

SECTION 2 – TO BE COMPLETED BY THE SENDER:

I. APHIS/CDC Authorization Number / Authorization Expiration Date

___ Copy information from Form 2, Section 1 (from recipient laboratory).

II. Complete Section D:

___ **Block D25:** List all select agents or toxins (**one per line**) that will be transferred (**only those select agents/toxins listed in Block C24 are authorized for transfer**). See Select Agent/Toxin list at www.selectagents.gov.

___ **Block D26:** Provide strain designation (**e.g. *Bacillus anthracis* – Ames strain**) of each select agent or toxin listed in **Block D25**, if applicable.

___ **Block D27:** List total number of items (**primary containers**) for each agent or toxin listed in **Block D25**.

___ **Block D28:** Enter the form for each item to be transferred (**e.g. powder, liquid, agar slant**).

___ **Block D29:** List total weight or volume for each select agent or toxin listed in **Block D25**.

___ **Block D30:** Full name of person at recipient entity notified of the shipment

___ **Block D31:** Date of notification to recipient entity.

___ **Block D32:** Type of notification.

___ **Block D33:** Full name of person who packaged the shipment.

___ **Block D34:** Number of packages shipped.

___ **Block D35:** Shipment date.

___ **Block D36:** Package description: size, shape, inner and outer package descriptions.

___ **Block D37:** Name of courier (e.g. FedEx).

___ **Block D38:** Airway bill number or tracking number.

___ Sender signs and dates completed section 2.

___ Fax or email Form 2, section 2 to APHIS or CDC **prior** to shipment.

___ Include a copy of completed Form 2, sections 1 and 2 inside of the package.

III. Sample Receipt:

___ Recipient laboratory will complete Section 3 upon receipt of the package. Recipient laboratory will provide the sender with a copy of the completed Form 2, Section 3.



APHIS/CDC SELECT AGENT FORM 3 CHECKLIST

KEY POINTS:

- APHIS/CDC has to be notified immediately upon discovery of the following:
 - Theft: Unauthorized removal of select agent or toxin.
 - Loss: Failure to account for select agent or toxin.
 - Release: Occupational exposure:
 - Release of a select agent/toxin outside of primary containment (e.g. Biological Safety Cabinet). For example, handling a sample or isolate on the open bench.
- Theft and loss: Notify local, state, or federal law enforcement agencies.
- Release: Notify local, state, and federal health agencies.
- Form 3 must be sent to APHIS/CDC within 7 calendar days after the discovery of theft, loss, or release.
- Completed by Responsible Official (RO) or Laboratory Supervisor.
- Copy of completed form and attachments must be maintained for 3 years.
- Tips:
 - Block 23: If you do not have a strain or ATCC number put “Human Isolate” if it came from a human sample.
 - Block 25:
 - Detailed timeline of events
 - Outcomes of risk assessment
 - Identification of root cause
 - Work practices/PPE used
 - Medical surveillance provided/planned

Submit completed form only once by email, fax, or mail

I. Complete Section 1 (Theft, Loss, or Release):

___ **Block 1:** Date of incident.

___ **Block 2:** Date immediate notification was reported to APHIS/CDC.

___ **Block 3:** Type of notification to APHIS/CDC.

___ **Block 4:** Name of Hospital or Laboratory - Non-Registered Entity (NRE).

___ **Block 5:** Proceed to Block 6 - **For select agent registered entities only.**

___ **Blocks 6-9:** Physical address including city, state, and 5-digit zip code.

___ **Block 10:** Full name of Laboratory Supervisor.

___ **Block 11:** 10-digit telephone number (**including extension**) of person listed in **Block 10**.

- ___ **Block 12:** 10-digit fax number of person listed in **Block 10**.
- ___ **Block 13:** Email address of person listed in **Block 10**.
- ___ **Block 14a: Human health:** Check the type of incident.
- ___ **Block 14b: Animal and plant health:** Check the type of incident.
- ___ **Block 14c:** Check if incident took place during **transfer** of a select agent or toxin (**If “yes”, complete sections 1, 2, and Appendix B**).
- ___ **Block 15:** Did release result in potential exposure? (**If “yes”, explain in Blocks 28 or 30**).
- ___ **Block 16:** Time incident occurred.
- ___ **Block 17:** Location of incident (building and room number).
- ___ **Block 18:** Location of incident within room (**e.g. freezer, incubator, etc.**).
- ___ **Block 19:** Identify the Biosafety level where the incident occurred.
- ___ **Block 20:** Date of last inventory (**for reporting loss only**).
- ___ **Block 21:** Name of Principal Investigator (PI), if applicable.

II. Complete Section 2 (Theft, Loss, or Release):

- ___ **Block 22:** Provide name of select agent or toxin.
- ___ **Block 23:** Provide strain designation of select agent or toxin listed in **Block 22**, list as Human isolate if it came from a human sample.
- ___ **Block 24:** Provide the quantity or amount of select agent or toxin stolen, lost, or released. If amount of release is unknown, then list the numbers of slants/plates.
- ___ **Block 25:** Detailed summary of events (**Include: timeline, risk assessment, root cause, work practices/PPE, medical surveillance**). Use Appendix A for additional space.

III: Complete Section 3 (Release or Occupational Exposure Only):

- ___ **Block 26:** Has an internal review of laboratory procedures and policies been performed? (**If “yes”, provide additional detail**).
- ___ **Block 27:** What were the hazards posed to humans due to the extent of release or occupational exposure? (**e.g. resulting infection/illness**).
- ___ **Block 28:** What is the extent of the release or exposure as it relates to the **proximity** of susceptible human, animals, or plants?

___ **Block 29:** Summarize decontamination of work surfaces after release.

___ **Block 30:** How many laboratorians were exposed? Has medical surveillance been provided?

___ Laboratory Supervisor must sign and date completed form.

___ Submit signed and completed form to APHIS or CDC.

IV: Appendix B (Theft, Loss or Release during Transfer):

___ **Block 1:** APHIS/CDC Form 2 authorization number.

___ **Block 2:** Shipment date.

___ **Block 3:** Provide name of courier (**e.g. FedEx**).

___ **Block 4:** Provide airway bill number, bill of lading number, or tracking number.

___ **Block 5:** Describe package (include size, shape, and description of inner and outer package).

___ **Block 6:** Was the package received by the recipient?

___ **Block 7:** Does the package appear to have been opened? (**Provide details in Block 5**)

___ **Block 8:** Was sender notified of incident?

___ **Block 9:** Was courier notified of incident?

___ Laboratory Supervisor must sign and date completed form.



APHIS/CDC SELECT AGENT FORM 4 CHECKLIST

Key Points:

Used by diagnostic/clinical laboratories and other entities to notify the Select Agent Program of the identification of a select agent or toxin as a result of testing:

- Diagnostic or verification testing: report within 7 calendar days of identification
- Proficiency testing: report within 90 calendar days of receipt of samples

APHIS/CDC Form 4A:

- Sections A & B: Completed by the LRN reference laboratory that confirms the identification of a select agent or toxin.
- Sections C & D: Completed by the clinical/diagnostic laboratory that submitted the sample for rule-out/confirmation.

APHIS CDC Form 4B:

- Completed by laboratories receiving a select agent proficiency.

APHIS/CDC Form 4C:

- Completed by Federal Law Enforcement Agency seizing a select agent.

Tips For Filling Out Form 4A Sections C & D:

- Reference ID number: Obtained from LRN reference laboratory (public health laboratory) with completed sections A and B.
- Sample type: When selecting clinical/diagnostic specimen or isolate, indicate where the sample type originated from: human, animal, or plant:
 - Clinical/diagnostic specimen: sample (not the isolate) that was derived directly from an individual human, animal, or plant.
 - Isolate: A purified culture obtained from a specimen or sample taken from a host or the environment.

Tips For Filling Out Sections C & D continued:

Block D8 Descriptions:

Use Transferred*

- If all OR part of the confirmed select agent or toxin was transferred to a select agent registered facility.
- Verify that APHIS/CDC Form 2 was initiated by the recipient.

Use Destroyed*

- Only if entire identified select agent or toxin was destroyed on site.
- Method of destruction: Autoclave, Chemical inactivation
- Select agent or toxin has to be destroyed on site before disposal.
- Provide actual date of destruction – DO NOT PROVIDE A FUTURE DATE!

Use Retained*

- If all OR part of the identified select agent or toxin was retained by your entity (only entities registered for the select agent or toxin can retain it).
- Selected if destruction will take place at a future date.

* Destruction or transfer must take place within 7 days unless the entity is registered for this select agent or toxin.

Sample Provider Information:

I. APHIS/CDC Form 4 Reference ID

___ Obtained from LRN reference laboratory (public health laboratory) with completed sections A and B.

II. Complete Section C:

___ **Block C1:** Full name of person completing the form.

___ **Block C2:** Email address of person completing the form.

___ **Block C3:** 10-digit telephone number (**including extension**) of person completing the form.

___ **Block C4:** Non-Registered Entity (NRE) number (**for clinical/diagnostic laboratories**).

___ **Block C5:** Full name of Facility or Laboratory Supervisor (**e.g. Microbiology Supervisor**).

___ **Block C6:** 10-digit telephone number of person listed in **Block C5**.

___ **Block C7:** 10-digit fax number of person listed in **Block C5**.

___ **Block C8:** Email address of person listed in **Block C5**.

___ **Block C9:** Full name of facility (**name in which business is conducted**).

___ **Block C10:** Physical street address of facility (**Do not use a PO Box**).

___ **Blocks C11-13:** Facility city, state and 5-digit zip code.

III. Complete Section D:

___ **Block D1:** Date specimen(s) was sent to LRN reference laboratory.

___ **Block D2:** Number of specimens provided to LRN reference laboratory.

___ **Block D3:** Case/patient/specimen ID/unique identifier(s).

___ **Block D4:** Type of samples provided (**e.g. clinical/diagnostic or isolate**) **AND** specify sample origin (**e.g. human, plant or animal**).

___ **Block D5:** Case/patient/sample origin (zip code) (**provide city and state if zip code is unknown**).

- ___ **Block D6:** Date LRN reference laboratory notified identification of Select Agent or Toxin.
- ___ **Block D7:** Select Agent or Toxin identified by the LRN reference laboratory.
- ___ **Block D8:** Disposition of identified select agent or toxin (**check all that apply**).
- ___ **Block D9:** Unintentional release and/or exposure due to the handling of samples outside of primary containment (BSC). **If yes, complete APHIS/CDC Form 3.**
- ___ **Block D10:** Will additional samples from original case/patient be received? **If yes, refer to APHIS/CDC Form 4 Guidance document for further instructions.**
- ___ **Block D11:** Has the provider of the original sample/specimen been notified of the identification of the select agent or toxin? (**check "N/A" if your facility processed the original sample**).
- ___ **Block D12:** Original sample provider entity name (**Use full name of treating physician, veterinarian or botanist if entity does not have a laboratory section**).
- ___ **Block D13:** Full name of sample provider Point of Contact (**e.g. Laboratory Supervisor**).
- ___ **Block D14:** Email address of person listed in **Block D13**.
- ___ **Block D15:** 10-digit telephone number (**including extension**) of person listed in **Block D13**.
- ___ **Block D16: Comments/Notes:** Provide additional information as it relates to the case.

IV. Signature/Date Signed

___ Responsible Official or Laboratory Supervisor must sign name and date. It is the person identified in block C5.

V. Submission of APHIS/CDC Form 4

___ Fax or Email completed sections C and D to APHIS or CDC.

Centers for Disease Control and Prevention (CDC)
Division of Select Agents and Toxins (DSAT)
Office: 404-718-2000
Fax: 404-718-2096
Email: CDCForm4@cdc.gov

___ Send copy of completed sections C and D to Reference Laboratory.



SELECT AGENT ALGORITHM GUIDE

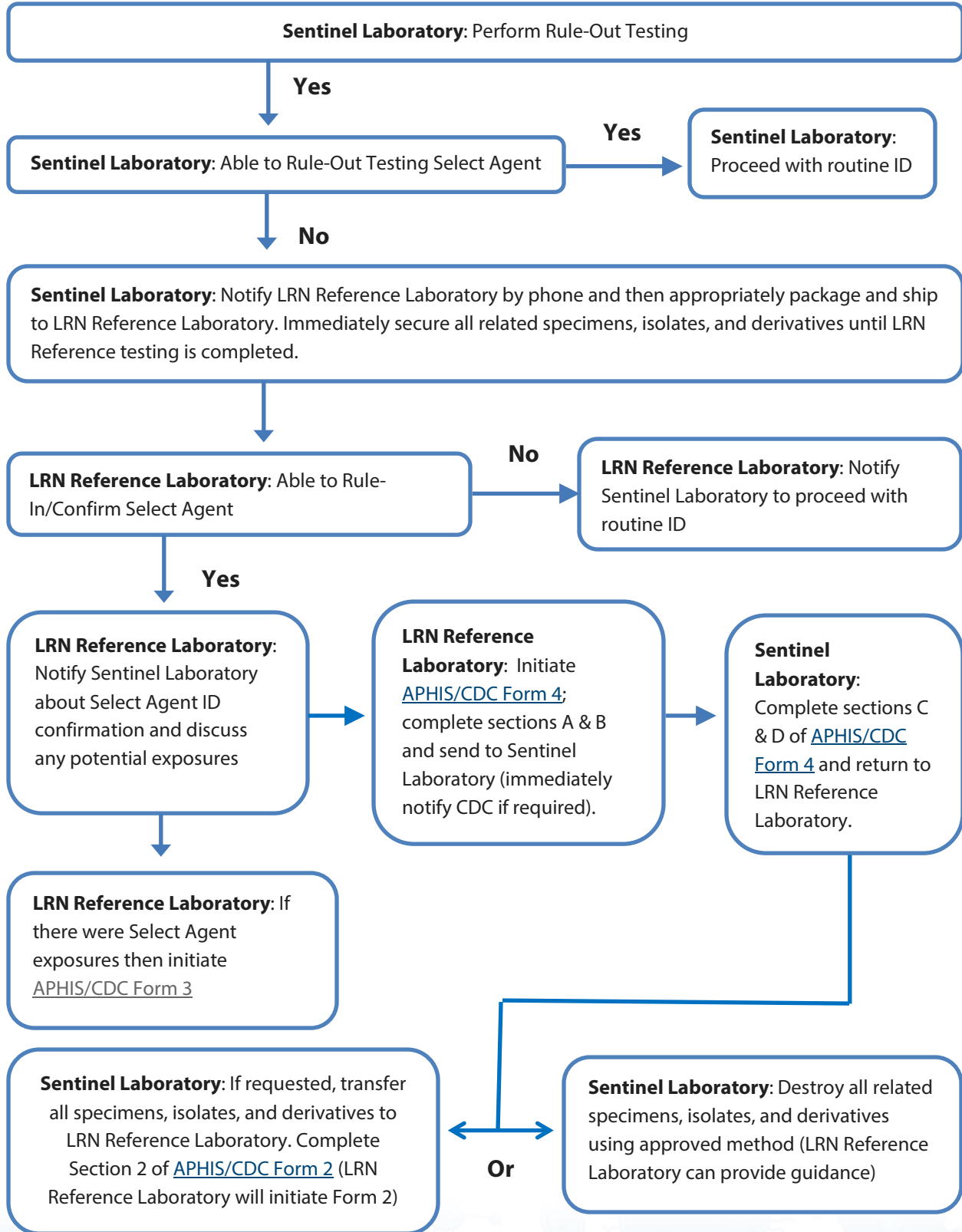

WHAT TO DO WHEN A SELECT AGENT IS SUSPECTED IN YOUR LAB

- ___ 1. Contact the LRN Reference Laboratory.
- ___ 2. Package the suspected isolate(s) according to DOT and IATA regulations and send to the LRN Reference Laboratory.
- ___ 3. Secure all remaining tubes, plates, specimens, and cultures from the patient. Look for everything on the same patient.
- ___ 4. Write down who worked on any cultures, and whether all work was done in a Biological Safety Cabinet. If work was performed on the open bench, note (a) what activities, (b) who performed the work, (c) who else was in the room. Note any physician(s) involved.
- ___ 5. If the LRN Reference Laboratory confirms the isolate as a select agent, prepare to:
 - a. Destroy all culture materials by on-site autoclaving or by overnight chemical decontamination in freshly made 10% bleach, followed by discarding with medical waste. This must be done within 7 days of report of identification by the LRN Reference Laboratory. [Decontamination of select agents isolated in the clinical laboratory job aid](#).
 - b. Note the date, time and name of person performing destruction.
 - c. Furnish information to LRN Reference Laboratory regarding name and phone number of referring physician. Furnish any other information for the purpose of filling out [CDC/APHIS Select Agent Form 4](#) to report the isolate.
 - d. Fill out Parts C and D of Form 4 and send to the LRN Reference Laboratory.
 - e. Work with LRN Reference Laboratory and/or State Health Department to assess any potential exposures to the organism and any need for prophylactic antibiotics.
 - f. Fill out [CDC/APHIS Select Agent Form 3](#) if any personnel were exposed or any improper handling of the isolate was discovered. The LRN Reference Laboratory or State Health Department may help with this.
 - g. Complete [CDC/APHIS Select Agent Form 2](#), if it is needed for a transfer of the isolate.
 - h. File copies of all forms for 3 years.

Select Agent website: www.selectagents.gov

The website is the resource for forms, guidance, regulations, list of select agents and toxins, including Tier 1 designations. Always download the forms directly from the website to ensure use of current version. All questions or concerns should be coordinated with the LRN Reference Laboratory and State Health Department.



Job Safety and Health IT'S THE LAW!

All workers have the right to:

- A safe workplace.
- Raise a safety or health concern with your employer or OSHA, or report a work-related injury or illness, without being retaliated against.
- Receive information and training on job hazards, including all hazardous substances in your workplace.
- Request an OSHA inspection of your workplace if you believe there are unsafe or unhealthy conditions. OSHA will keep your name confidential. You have the right to have a representative contact OSHA on your behalf.
- Participate (or have your representative participate) in an OSHA inspection and speak in private to the inspector.
- File a complaint with OSHA within 30 days (by phone, online or by mail) if you have been retaliated against for using your rights.
- See any OSHA citations issued to your employer.
- Request copies of your medical records, tests that measure hazards in the workplace, and the workplace injury and illness log.

This poster is available free from OSHA.

Contact OSHA. We can help.

Employers must:

- Provide employees a workplace free from recognized hazards. It is illegal to retaliate against an employee for using any of their rights under the law, including raising a health and safety concern with you or with OSHA, or reporting a work-related injury or illness.
- Comply with all applicable OSHA standards.
- Report to OSHA all work-related fatalities within 8 hours, and all inpatient hospitalizations, amputations and losses of an eye within 24 hours.
- Provide required training to all workers in a language and vocabulary they can understand.
- Prominently display this poster in the workplace.
- Post OSHA citations at or near the place of the alleged violations.

FREE ASSISTANCE to identify and correct hazards is available to small and medium-sized employers, without citation or penalty, through OSHA-supported consultation programs in every state.



1-800-321-OSHA (6742) • TTY 1-877-889-5627 • www.osha.gov

OSHA 3165-048 2015

CATEGORY A VS. SELECT AGENT LIST COMPARISON

CATEGORY A INFECTIOUS SUBSTANCE LIST VS. SELECT AGENT LIST COMPARISON

The list of Select Biological Agents and Toxins closely resembles the Category A indicative list of organisms, although the overlap is not identical. There are some key differences between the lists, and both lists should be consulted for Category A shipping purposes. Sample classification for inclusion as a Category A shipment should take into account the organisms on the Health and Human Services (HHS) / U.S. Department of Agriculture (USDA) Select Agent list. Confirmed select agents must always be shipped as Category A, and potential or suspect select agents as “Suspected Category A”. The HHS/USDA Select Biological Agent and Toxin list can be found here:

<http://www.selectagents.gov/SelectAgentsandToxinsList.html>

Key differences between the lists:

1. The Category A and Select Agent lists are not identical.
2. Select Agent list is a complete list of regulated organisms and toxins.
3. Category A list is an indicative example list, and not considered to be all-inclusive.
4. Select agent list does not have the word “culture” after any names of organisms or toxins.
5. Category A list has the word “culture” only after some of the listed organisms, indicating that specific organism is only required to be classified as Category A when shipped in culture form.
6. Select Agent list is comprised of infectious microorganisms and toxins.
7. Category A list is comprised only of infectious microorganisms. Organisms that produce and that may contain a toxin are classified as Division 6.2 material and shipped as infectious material. If a purified or isolated toxin is shipped it is classified as Division 6.1 material.

THE FOLLOWING ORGANISMS AND TOXINS APPEAR ON THE SELECT AGENT LIST, BUT CURRENTLY NOT ON THE CATEGORY A LIST:

Abrin

African horse sickness virus

Avian influenza virus³

Botulinum neurotoxins*

Conotoxins (Short, paralytic alpha conotoxins containing the following amino acid sequence

X₁CCX₂PACGX₃X₄X₅X₆CX₇)¹

Diacetoxyscirpenol

Lujo virus

*Mycoplasma capricolum*³

Newcastle disease virus^{2,3}

Peronosclerospora philippinensis

(*Peronosclerospora sacchari*)

Phoma glycinicola (formerly *Pyrenochaeta glycinis*)

Ralstonia solanacearum

Rathayibacter toxicus

Reconstructed replication competent forms of the 1918 pandemic influenza virus containing any portion of the coding regions of all eight

gene segments (Reconstructed 1918 Influenza virus)
Ricin
Rickettsia prowazekii
SARS-associated coronavirus (SARS-CoV)
Saxitoxin
Sclerophthora rayssiae
South American Haemorrhagic Fever virus (Chapare)

Staphylococcal enterotoxins A,B,C,D,E subtypes
Synchytrium endobioticum
T-2 toxin
Tetrodotoxin
Variola major virus (Smallpox virus)*
Variola minor virus (Alastrim)*
Xanthomonas oryzae

LEGEND:

*Denotes Tier 1 Agent

¹ C = Cysteine residues are all present as disulfides, with the 1st and 3rd Cysteine, and the 2nd and 4th Cysteine forming specific disulfide bridges; The consensus sequence includes known toxins α -MI and α -GI (shown above) as well as α -GIA, Ac1.1a, α -CnIA, α -CnIB; X1 = any amino acid(s) or Des-X; X2 = Asparagine or Histidine; P = Proline; A = Alanine; G = Glycine; X3 = Arginine or Lysine; X4 = Asparagine, Histidine, Lysine, Arginine, Tyrosine, Phenylalanine or Tryptophan; X5 = Tyrosine, Phenylalanine, or Tryptophan; X6 = Serine, Threonine, Glutamate, Aspartate, Glutamine, or Asparagine; X7 = Any amino acid(s) or Des X and; "Des X" = "an amino acid does not have to be present at this position." For example if a peptide sequence were XCCHPA then the related peptide CCHPA would be designated as Des-X.

² A virulent Newcastle disease virus (avian paramyxovirus serotype 1) has an intracerebral pathogenicity index in day-old chicks (*Gallus gallus*) of 0.7 or greater or has an amino acid sequence at the fusion (F) protein cleavage site that is consistent with virulent strains of Newcastle disease virus. A failure to detect a cleavage site that is consistent with virulent strains does not confirm the absence of a virulent virus.

³ Select agents that meet any of the following criteria are excluded from the requirements of this part: Any low pathogenic strains of avian influenza virus, South American genotype of eastern equine encephalitis virus, west African clade of Monkeypox viruses, any strain of Newcastle disease virus which does not meet the criteria for virulent Newcastle disease virus, all subspecies *Mycoplasma capricolum* except subspecies *capripneumoniae* (contagious caprine pleuropneumonia), all subspecies *Mycoplasma mycoides* except subspecies *mycoides* small colony (Mmm SC) (contagious bovine pleuropneumonia), and any subtypes of Venezuelan equine encephalitis virus except for Subtypes IAB or IC, provided that the individual or entity can verify that the agent is within the exclusion category (Revised 9/10/13).

Select Agent website: www.selectagents.gov

The website is the resource for forms, guidance, regulations, list of select agents and toxins, including Tier 1 designations. Always download the forms directly from the website to ensure use of current version. All questions or concerns should be coordinated with the LRN Reference Laboratory and State Health Department.

The following organisms appear on the Category A list, but currently not on the Select Agent list:

- *Chlamydia psittaci* (avian) (cultures only)
- Classical swine fever virus (cultures only)
- *Coccidioides immitis* (cultures only)
- Dengue virus (cultures only)
- *Escherichia coli*, verotoxigenic (cultures only)
- Hantavirus causing hemorrhagic fever with renal syndrome
- Hantaan virus
- Hepatitis B virus (cultures only)
- Herpes B virus (cultures only)
- Human immunodeficiency virus (cultures only)
- *Mycobacterium tuberculosis* (cultures only)
- Poliovirus virus (cultures only)
- Rabies virus (cultures only)
- *Rickettsia rickettsii* (cultures only)
- *Shigella dysenteriae* type 1 (cultures only)
- Venezuelan equine encephalitis virus (cultures only)
- Vesicular stomatitis virus (cultures only)
- West Nile virus (cultures only)
- Yellow fever virus (cultures only)

Always refer to public health authorities (e.g., CDC, WHO, or other state or local public health agencies) for guidance when transporting a new or emerging pathogen or when there is a transporting concern.



NLTN BIOSAFETY CHECKLIST FOR CLINICAL LABORATORIES* BIOSAFETY LEVEL 2

Facility Name: _____

Date: _____

Laboratory Name/Location: _____ Supervisor: _____

Items are based on the Biosafety Level 2 (BSL-2) Section of the *Biosafety in Microbiological and Biomedical Laboratories*, 5th Edition, 2009.

Check the response that best describes the laboratory in which work will be performed.

*Adapted from the Select Agent BSL-2 Checklist on the Select Agent website: <http://www.selectagents.gov/>

NA = not applicable

Reference	Statement	Response			Comments
		Yes	No	N/A	
Biosafety in Microbiological and Biomedical Laboratories (BMBL) 5th edition HHS Publication No. (CDC) 21-1112 Revised December 2009	In developing a biosafety plan, an individual or entity should consider: The CDC/NIH publication, "Biosafety in Microbiological and Biomedical Laboratories (BMBL)." This document is available on the National Select Agent Registry website at http://www.selectagents.gov/ and on the CDC website at http://www.cdc.gov/biosafety/publications/bmb15/index.htm Biosecurity should be part of a biosafety plan. The BMBL has a section on biosecurity.				
BMBL	Security should be considered and implemented to protect pathogenic agents from misuse. If a select agent has been confirmed contact your LRN reference laboratory.				
BMBL	Drills or exercises should be conducted at least annually to test and evaluate the effectiveness of the plan.				
BMBL	The plan should be reviewed annually and revised, as necessary, after any drill or exercise and after any incident.				

Reference	Statement	Response			Comments
		Yes	No	N/A	
A	Standard Microbiological Practices				
BMBL: A1	The laboratory supervisor must enforce the institutional policies that control access to the laboratory.				
BMBL: A2	Persons must wash their hands after working with potentially hazardous materials and before leaving the laboratory.				
BMBL: A3	Eating, drinking, smoking, handling contact lenses, applying cosmetics, and storing food for human consumption must not be permitted in laboratory areas.				
BMBL: A3	Food must be stored outside the laboratory area in cabinets or refrigerators designated and used for this purpose.				
BMBL: A4	Mouth pipetting is prohibited; mechanical pipetting devices must be used.				
BMBL: A5	Policies for the safe handling of sharps, such as needles, scalpels, pipettes, and broken glassware must be developed and implemented.				
BMBL: A5	Whenever practical, laboratory supervisors should adopt improved engineering and work practice controls that reduce risk of sharps injuries.				
BMBL: A5	Precautions, including those listed below, must always be taken with sharp items. These include:				
BMBL: A5-a	Careful management of needles and other sharps are of primary importance. Needles must not be bent, sheared, broken, recapped, removed from disposable syringes, or otherwise manipulated by hand before disposal.				
BMBL: A5-b	Used disposable needles and syringes must be carefully placed in conveniently located puncture-resistant containers used for sharps disposal.				
BMBL: A5-c	Non-disposable sharps must be placed in a hard walled container for transport to a processing area for decontamination, preferably by autoclaving.				

Reference	Statement	Response			Comments
		Yes	No	N/A	
A	Standard Microbiological Practices				
BMBL: A5-d	Broken glassware must not be handled directly. Instead, it must be removed using a brush and dustpan, tongs, or forceps.				
BMBL: A5-d	Plasticware should be substituted for glassware whenever possible.				
BMBL: A6	Perform all procedures to minimize the creation of splashes and/or aerosols.				
BMBL: A7	Decontaminate work surfaces after completion of work and after any spill or splash of potentially infectious material with appropriate disinfectant.				
BMBL: A8	Decontaminate all cultures, stocks, and other potentially infectious materials before disposal (including off-site decontamination/disposal) using an effective method.. Note: if you have a confirmed select agent contact your LRN reference laboratory for guidance in how to properly decontaminate all cultures, etc. before disposal.				
BMBL: A8	Depending on where the decontamination will be performed, the following methods should be used prior to transport:				
BMBL: A8-a	Materials to be decontaminated outside of the immediate laboratory must be placed in a durable, leak proof container and secured for transport.				
BMBL: A8-b	Materials to be removed from the facility for decontamination must be packed in accordance with applicable local, state, and federal regulations.				
BMBL: A9	A sign incorporating the universal biohazard symbol must be posted at the entrance to the laboratory when infectious agents are present. Posted information must include: the laboratory's biosafety level, the supervisor's name (or other responsible personnel), telephone number, and required procedures for entering and exiting the laboratory.				

Reference	Statement	Response			Comments
		Yes	No	N/A	
A	Standard Microbiological Practices				
BMBL: A9	Agent information should be posted in accordance with the institutional policy.				
BMBL: A10	An effective integrated pest (insect and rodent) management program is required. See Appendix G of BMBL.				
BMBL: A11	The laboratory supervisor must ensure that laboratory personnel receive appropriate training regarding their duties, the necessary precautions to prevent exposures, and exposure evaluation procedures. Personnel must receive annual updates or additional training when procedural or policy changes occur.				
BMBL: A11	Personal health status may impact an individual's susceptibility to infection, ability to receive immunizations or prophylactic interventions. Therefore, all laboratory personnel and particularly women of child-bearing age should be provided with information regarding immune competence and conditions that may predispose them to infection. Individuals having these conditions should be encouraged to self-identify to the institution's healthcare provider for appropriate counseling and guidance.				

Reference	Statement	Response			Comments
		Yes	No	N/A	
B	Special Practices				
BMBL: B1	All persons entering the laboratory must be advised of the potential hazards and meet specific entry/exit requirements.				
BMBL: B2	Laboratory personnel must be provided medical surveillance, as appropriate, and offered available immunizations for agents handled or potentially present in the laboratory.				

Reference	Statement	Response			Comments
		Yes	No	N/A	
B	Special Practices				
BMBL: B3	Each institution should consider the need for collection and storage of serum samples from at-risk personnel.				
BMBL: B4	A laboratory-specific biosafety manual must be prepared and adopted as policy.				
BMBL: B4	The biosafety manual must be available and accessible.				
BMBL: B5	The laboratory supervisor must ensure that laboratory personnel demonstrate proficiency in standard and special microbiological practices before working with BSL-2 agents.				
BMBL: B6	Potentially infectious materials must be placed in a durable, leak proof container during collection, handling, processing, storage, or transport within a facility.				
BMBL: B7	Laboratory equipment should be routinely decontaminated, as well as, after spills, splashes, or other potential contamination.				
BMBL: B7-a	Spills involving infectious materials must be contained, decontaminated, and cleaned up by staff properly trained and equipped to work with infectious material.				
BMBL: B7-b	Equipment must be decontaminated before repair, maintenance, or removal from the laboratory.				
BMBL: B8	Incidents that may result in exposure to infectious materials must be immediately evaluated and treated according to procedures described in the laboratory biosafety safety manual. All such incidents must be reported to the laboratory supervisor.				
BMBL: B8	Medical evaluation, surveillance, and treatment should be provided and appropriate records maintained.				
BMBL: B9	Animals and plants not associated with the work being performed must not be permitted in the laboratory.				

Reference	Statement	Response			Comments
		Yes	No	N/A	
B	Special Practices				
BMBL: B10	All procedures involving the manipulation of infectious materials that may generate an aerosol should be conducted within a BSC or other physical containment devices.				

Reference	Statement	Response			Comments
		Yes	No	N/A	
C	Safety Equipment (Primary Barriers and Personal Protective Equipment)				
BMBL: C1	Properly maintained BSCs (preferably Class II), other appropriate personal protective equipment, or other physical containment devices must be used whenever:				
BMBL: C1-a	Procedures with a potential for creating infectious aerosols or splashes are conducted. These may include pipetting, centrifuging, grinding, blending, shaking, mixing, sonicating, opening containers of infectious materials, and harvesting infected tissues from animals or eggs.				
BMBL: C1-b	High concentrations or large volumes of infectious agents are used. Such materials may be centrifuged in the open laboratory using sealed rotor heads or centrifuge safety cups.				
BMBL: C2	Protective laboratory coats, gowns, smocks, or uniforms designated for laboratory use must be worn while working with hazardous materials.				
BMBL: C2	Remove protective clothing before leaving for non-laboratory areas (e.g., cafeteria, library, and administrative offices).				
BMBL: C2	Dispose of protective clothing appropriately, or deposit it for laundering by the institution. Do not take used laboratory clothing home				



Reference	Statement	Response			Comments
		Yes	No	N/A	
C	Safety Equipment (Primary Barriers and Personal Protective Equipment)				
BMBL: C3	Eye and face protection (goggles, mask, face shield or other splatter guard) is used for anticipated splashes or sprays of infectious or other hazardous materials when the microorganisms must be handled outside the BSC or containment device.				
BMBL: C3	Eye and face protection must be disposed of with other contaminated laboratory waste or decontaminated before reuse.				
BMBL: C3	Persons who wear contact lenses in laboratories should also wear eye protection.				
BMBL: C4	Gloves must be worn to protect hands from exposure to hazardous materials.				
BMBL: C4	Glove selection should be based on an appropriate risk assessment.				
BMBL: C4	Alternatives to latex gloves should be available.				
BMBL: C4	Gloves must not be worn outside the laboratory.				
	In addition, BSL-2 laboratory workers should:				
BMBL: C4-a	Change gloves when contaminated, integrity has been compromised, or when otherwise necessary.				
BMBL: C4-b	Remove gloves and wash hands when work with hazardous materials has been completed and before leaving the laboratory.				
BMBL: C4-c	Do not wash or reuse disposable gloves.				
BMBL: C4-c	Dispose of used gloves with other contaminated laboratory waste.				
BMBL: C4-c	Hand washing protocols must be rigorously followed.				

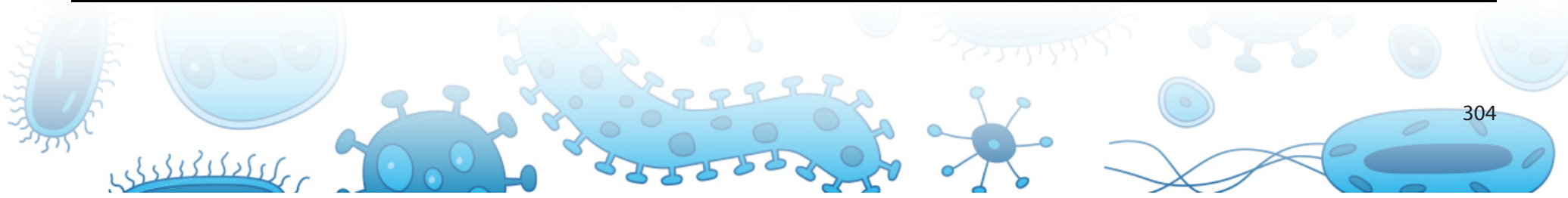

Reference	Statement	Response			Comments
		Yes	No	N/A	
D	Laboratory Facilities (Secondary Barriers)				
BMBL: D1	Laboratory doors should be self-closing and have locks in accordance with the institutional policies.				
BMBL: D2	Laboratories must have a sink for hand washing. The sink may be manually, hands-free, or automatically operated. It should be located near the exit door.				
BMBL: D3	The laboratory should be designed so that it can be easily cleaned and decontaminated.				
BMBL: D3	Carpets and rugs in laboratories are not permitted.				
BMBL: D4	Laboratory furniture must be capable of supporting anticipated loads and uses.				
BMBL: D4	Spaces between benches, cabinets, and equipment should be accessible for cleaning.				
BMBL: D4-a	Bench tops must be impervious to water and resistant to heat, organic solvents, acids, alkalis, and other chemicals.				
BMBL: D4-b	Chairs used in laboratory work must be covered with a non-porous material that can be easily cleaned and decontaminated with appropriate disinfectant.				
BMBL: D5	Laboratory windows that open to the exterior are not recommended. However, if a laboratory does have windows that open to the exterior, they must be fitted with screens.				
BMBL: D6	BSCs must be installed so that fluctuations of the room air supply and exhaust do not interfere with proper operations.				
BMBL: D6	BSCs should be located away from doors, windows that can be opened, heavily traveled laboratory areas, and other possible airflow disruptions.				
BMBL: D7	Vacuum lines should be protected with liquid disinfectant traps.				
BMBL: D8	An eyewash station must be readily available.				

Reference	Statement	Response			Comments
		Yes	No	N/A	
D	Laboratory Facilities (Secondary Barriers)				
BMBL: D9	There are no specific requirements on ventilation systems. However, planning of new facilities should consider mechanical ventilation systems that provide an inward flow of air without recirculation to spaces outside of the laboratory.				
BMBL: D10	HEPA filtered exhaust air from a Class II BSC can be safely re-circulated back into the laboratory environment if the cabinet is tested and certified at least annually and operated according to manufacturer's recommendations. BSCs can also be connected to the laboratory exhaust system by either a thimble (canopy) connection or directly exhausted to the outside through a hard connection.				
BMBL: D10	Provisions to assure proper safety cabinet performance and air system operation must be verified.				
BMBL: D11	A method for decontaminating all laboratory wastes should be available in the facility (e.g., autoclave, chemical disinfection, incineration, or other validated decontamination method). Document if using an off-site facility for decontamination/disposal.				

Inspector Summary and Comments:

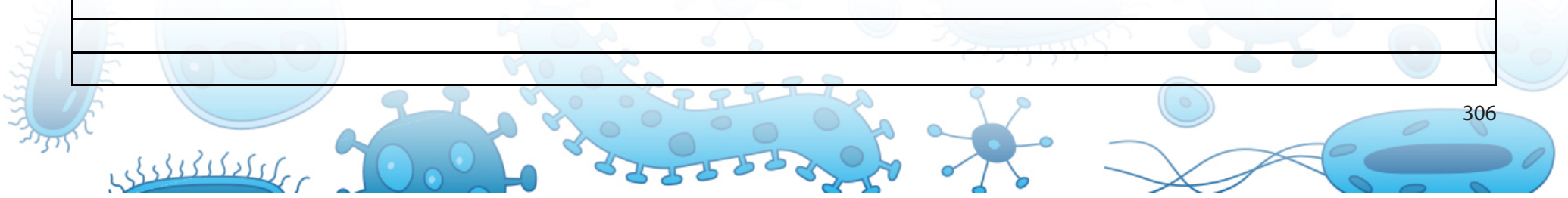

Recommendations:	
Inspector Completing Checklist:	Date:
Other Inspectors Present:	Date:

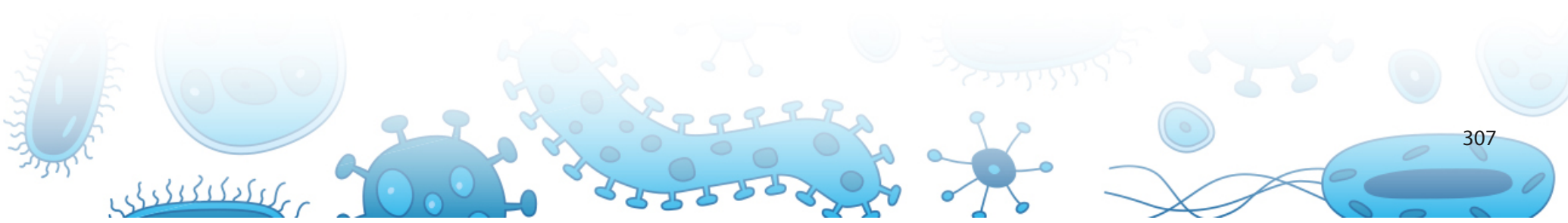

NLTN BIOSAFETY CHECKLIST FOR CLINICAL LABORATORIES* BIOSAFETY LEVEL 3

Facility Name: _____

Date: _____

Laboratory Name/Location: _____ Supervisor: _____

Items are based on the Biosafety Level 3 (BSL-3) Section of the *Biosafety in Microbiological and Biomedical Laboratories*, 5th Edition, 2009.

Check the response that best describes the laboratory in which work will be performed.

*Adapted from the Select Agent BSL-3 Checklist on the Select Agent website: <http://www.selectagents.gov/>

NA = not applicable

Reference	Statement	Response			Comments
		Yes	No	N/A	
Biosafety in Microbiological and Biomedical Laboratories (BMBL) 5th edition HHS Publication No. (CDC) 21-1112 Revised December 2009	In developing a biosafety plan, an individual or entity should consider: The CDC/NIH publication, "Biosafety in Microbiological and Biomedical Laboratories (BMBL)." This document is available on the National Select Agent Registry website at http://www.selectagents.gov/ and on the CDC website at http://www.cdc.gov/biosafety/publications/bmb15/index.htm Biosecurity should be part of a biosafety plan. The BMBL has a section on biosecurity.				
BMBL	Security should be considered and implemented to protect pathogenic agents from misuse. If a select agent has been confirmed contact your LRN reference laboratory.				
BMBL	Drills or exercises should be conducted at least annually to test and evaluate the effectiveness of the plan.				
BMBL	The plan should be reviewed annually and revised, as necessary, after any drill or exercise and after any incident.				



Reference	Statement	Response			Comments
		Yes	No	N/A	
A	Standard Microbiological Practices				
BMBL: A1	The laboratory supervisor must enforce the institutional policies that control access to the laboratory.				
BMBL: A2	Persons must wash their hands after working with potentially hazardous materials and before leaving the laboratory.				
BMBL: A3	Eating, drinking, smoking, handling contact lenses, applying cosmetics, and storing food for human consumption must not be permitted in laboratory areas.				
BMBL: A3	Food must be stored outside the laboratory area in cabinets or refrigerators designated and used for this purpose.				
BMBL: A5	Policies for the safe handling of sharps, such as needles, scalpels, pipettes, and broken glassware must be developed and implemented.				
BMBL: A5	Whenever practical, laboratory supervisors should adopt improved engineering and work practice controls that reduce risk of sharps injuries.				
BMBL: A5	Precautions, including those listed below, must always be taken with sharp items. These include:				
BMBL: A5-a	Careful management of needles and other sharps are of primary importance. Needles must not be bent, sheared, broken, recapped, removed from disposable syringes, or otherwise manipulated by hand before disposal.				
BMBL: A5-b	Used disposable needles and syringes must be carefully placed in conveniently located puncture-resistant containers used for sharps disposal.				
BMBL: A5-c	Non-disposable sharps must be placed in a hard walled container for transport to a processing area for decontamination, preferably by autoclaving.				
BMBL: A5-d	Broken glassware must not be handled directly. Instead, it must be removed using a brush and dustpan, tongs, or forceps.				

Reference	Statement	Response			Comments
		Yes	No	N/A	
A	Standard Microbiological Practices				
BMBL: A5-d	Plasticware should be substituted for glassware whenever possible.				
BMBL: A6	Perform all procedures to minimize the creation of splashes and/or aerosols.				
BMBL: A7	Decontaminate work surfaces after completion of work and after any spill or splash of potentially infectious material with appropriate disinfectant.				
BMBL: A8	Decontaminate all cultures, stocks, and other potentially infectious materials before disposal (including off-site decontamination/disposal) using an effective method. Note: if you have a confirmed select agent contact your LRN reference laboratory for guidance in how to properly decontaminate all cultures, etc. before disposal.				
BMBL: A8	A method for decontaminating all laboratory wastes should be available in the facility, preferably within the laboratory (e.g., autoclave, chemical disinfection, incineration, or other validated decontamination method).				
BMBL: A8-a	Depending on where the decontamination will be performed, the following methods should be used prior to transport: Materials to be decontaminated outside of the immediate laboratory must be placed in a durable, leak proof container and secured for transport.				
BMBL: A8-b	Depending on where the decontamination will be performed, the following methods should be used prior to transport: Materials to be removed from the facility for decontamination must be packed in accordance with applicable local, state, and federal regulations.				



Reference	Statement	Response			Comments
		Yes	No	N/A	
A	Standard Microbiological Practices				
BMBL: A9	A sign incorporating the universal biohazard symbol must be posted at the entrance to the laboratory when infectious agents are present. Posted information must include: the laboratory's biosafety level, the supervisor's name (or other responsible personnel), telephone number, and required procedures for entering and exiting the laboratory.				
BMBL: A9	Agent information should be posted in accordance with the institutional policy.				
BMBL: A10	An effective integrated pest (insect and rodent) management program is required. See Appendix G of BMBL.				
BMBL: A11	The laboratory supervisor must ensure that laboratory personnel receive appropriate training regarding their duties, the necessary precautions to prevent exposures, and exposure evaluation procedures. Personnel must receive annual updates or additional training when procedural or policy changes occur.				
BMBL: A11	Personal health status may impact an individual's susceptibility to infection, ability to receive immunizations or prophylactic interventions. Therefore, all laboratory personnel and particularly women of child-bearing age should be provided with information regarding immune competence and conditions that may predispose them to infection. Individuals having these conditions should be encouraged to self-identify to the institution's healthcare provider for appropriate counseling and guidance.				



Reference	Statement	Response			Comments
		Yes	No	N/A	
B	Special Practices				
BMBL: B1	All persons entering the laboratory must be advised of the potential hazards and meet specific entry/exit requirements.				
BMBL: B2	Laboratory personnel must be provided medical surveillance, as appropriate, and offered available immunizations for agents handled or potentially present in the laboratory.				
BMBL: B3	Each institution should consider the need for collection and storage of serum samples from at-risk personnel.				
BMBL: B4	A laboratory-specific biosafety manual must be prepared and adopted as policy.				
BMBL: B4	The biosafety manual must be available and accessible.				
BMBL: B5	The laboratory supervisor must ensure that laboratory personnel demonstrate proficiency in standard and special microbiological practices before working with BSL-3 agents.				
BMBL: B6	Potentially infectious materials must be placed in a durable, leak proof container during collection, handling, processing, storage, or transport within a facility.				
BMBL: B7	Laboratory equipment should be routinely decontaminated, as well as, after spills, splashes, or other potential contamination.				
BMBL: B7-a	Spills involving infectious materials must be contained, decontaminated, and cleaned up by staff properly trained and equipped to work with infectious material.				
BMBL: B7-b	Equipment must be decontaminated before repair, maintenance, or removal from the laboratory.				



Reference	Statement	Response			Comments
		Yes	No	N/A	
B	Special Practices				
BMBL: B8	Incidents that may result in exposure to infectious materials must be immediately evaluated and treated according to procedures described in the laboratory biosafety safety manual. All such incidents must be reported to the laboratory supervisor.				
BMBL: B8	Medical evaluation, surveillance, and treatment should be provided and appropriate records maintained.				
BMBL: B9	Animals and plants not associated with the work being performed must not be permitted in the laboratory.				
BMBL: B10	All procedures involving the manipulation of infectious materials that may generate an aerosol should be conducted within a BSC or other physical containment devices.				
BMBL: B10	No work with open vessels is conducted on the bench.				
BMBL: B10	When a procedure cannot be performed within a BSC, a combination of personal protective equipment and other containment devices, such as a centrifuge safety cup or sealed rotor, must be used.				

Reference	Statement	Response			Comments
		Yes	No	N/A	
C	Safety Equipment (Primary Barriers and Personal Protective Equipment)				
BMBL: C1	All procedures involving the manipulation of infectious materials must be conducted within a BSC (preferably Class II or Class III), or other physical containment devices.				
BMBL: C2	Workers in the laboratory wear protective laboratory clothing with a solid-front, such as tie-back or wrap-around gowns, scrub suits, or coveralls.				
BMBL: C2	Protective clothing is not worn outside of the laboratory.				

Reference	Statement	Response			Comments
		Yes	No	N/A	
C	Safety Equipment (Primary Barriers and Personal Protective Equipment)				
BMBL: C2	Reusable clothing is decontaminated before being laundered.				
BMBL: C2	Clothing is changed when contaminated.				
BMBL: C3	Eye and face protection (goggles, mask, face shield or other splatter guard) is used for anticipated splashes or sprays of infectious or other hazardous materials.				
BMBL: C3	Eye and face protection must be disposed of with other contaminated laboratory waste or decontaminated before reuse.				
BMBL: C3	Persons who wear contact lenses in laboratories should also wear eye protection.				
BMBL: C4	Gloves must be worn to protect hands from exposure to hazardous materials.				
BMBL: C4	Glove selection should be based on an appropriate risk assessment.				
BMBL: C4	Alternatives to latex gloves should be available.				
BMBL: C4	Gloves must not be worn outside the laboratory.				
	In addition, BSL-3 laboratory workers should:				
BMBL: C4-a	Change gloves when contaminated, integrity has been compromised, or when otherwise necessary.				
BMBL: C4-a	Wear two pairs of gloves when appropriate.				
BMBL: C4-b	Remove gloves and wash hands when work with hazardous materials has been completed and before leaving the laboratory.				
BMBL: C4-c	Do not wash or reuse disposable gloves.				
BMBL: C4-c	Dispose of used gloves with other contaminated laboratory waste.				
BMBL: C4-c	Hand washing protocols must be rigorously followed.				



Reference	Statement	Response			Comments
		Yes	No	N/A	
D	Laboratory Facilities (Secondary Barriers)				
BMBL: D1	Laboratory doors should be self-closing and have locks in accordance with the institutional policies.				
BMBL: D1	The laboratory must be separated from areas that are open to unrestricted traffic flow within the building.				
BMBL: D1	Laboratory access is restricted.				
BMBL: D1	Access to the laboratory is through two self-closing doors.				
BMBL: D1	A clothing change room (anteroom) may be included in the passageway between the two self-closing doors.				
BMBL: D2	Laboratories must have a sink for hand washing. The sink may be hands-free, or automatically operated. It should be located near the exit door.				
BMBL: D2	If the laboratory is segregated into different laboratories, a sink must also be available for hand washing in each zone.				
BMBL: D2	Additional sinks may be required as determined by the risk assessment.				
BMBL: D3	The laboratory should be designed so that it can be easily cleaned and decontaminated.				
BMBL: D3	Carpets and rugs in laboratories are not permitted.				
BMBL: D3	Seams, floors, walls, and ceiling surfaces should be sealed.				
BMBL: D3	Spaces around doors and ventilation openings should be capable of being sealed to facilitate space decontamination.				
BMBL: D3-a	Floors must be slip resistant, impervious to liquids, and resistant to chemicals.				
BMBL: D3-a	Consideration should be given to the installation of seamless, sealed, resilient or poured floors, with integral cove bases.				
BMBL: D3-b	Walls should be constructed to produce a sealed smooth finish that can be easily cleaned and decontaminated.				

Reference	Statement	Response			Comments
		Yes	No	N/A	
D	Laboratory Facilities (Secondary Barriers)				
BMBL: D3-c	Ceilings should be constructed, sealed, and finished in the same general manner as walls.				
BMBL: D3	Decontamination of the entire laboratory should be considered when there has been gross contamination of the space, significant changes in laboratory usage, for major renovations, or maintenance shut downs.				
BMBL: D3	Selection of the appropriate materials and methods used to decontaminate the laboratory must be based on the risk assessment.				
BMBL: D4	Laboratory furniture must be capable of supporting anticipated loads and uses.				
BMBL: D4	Spaces between benches, cabinets, and equipment should be accessible for cleaning.				
BMBL: D4-a	Bench tops must be impervious to water and resistant to heat, organic solvents, acids, alkalis, and other chemicals.				
BMBL: D4-b	Chairs used in laboratory work must be covered with a non-porous material that can be easily cleaned and decontaminated with appropriate disinfectant.				
BMBL: D5	All windows in the laboratory must be sealed.				
BMBL: D6	BSCs must be installed so that fluctuations of the room air supply and exhaust do not interfere with proper operations.				
BMBL: D6	BSCs should be located away from doors, heavily traveled laboratory areas, and other possible airflow disruptions.				
BMBL: D7	Vacuum lines must be protected with HEPA filters, or their equivalent.				
BMBL: D7	Filters must be replaced as needed.				
BMBL: D7	Liquid disinfectant traps may be required.				
BMBL: D8	An eyewash station must be readily available in the laboratory.				
BMBL: D9	A ducted air ventilation system is required.				

Reference	Statement	Response			Comments
		Yes	No	N/A	
D	Laboratory Facilities (Secondary Barriers)				
BMBL: D9	This system must provide sustained directional airflow by drawing air into the laboratory from “clean” areas toward “potentially contaminated” areas.				
BMBL: D9	The laboratory shall be designed such that under failure conditions the airflow will not be reversed.				
BMBL: D9-a	Laboratory personnel must be able to verify directional air flow.				
BMBL: D9-a	A visual monitoring device which confirms directional air flow must be provided at the laboratory entry.				
BMBL: D9-a	Audible alarms should be considered to notify personnel of air flow disruption.				
BMBL: D9-b	The laboratory exhaust air must not re-circulate to any other area of the building.				
BMBL: D9-c	The laboratory building exhaust air should be dispersed away from occupied areas and from building air intake locations or the exhaust air must be HEPA filtered.				
BMBL: D9-d	HEPA filter housings should have gas-tight isolation dampers; decontamination ports; and/or bag-in/bag-out capability with appropriate decontamination procedures. The HEPA filter housing should allow for leak testing of each filter and assembly. The filters and the housing should be certified at least annually.				
BMBL: D10	HEPA filtered exhaust air from a Class II BSC can be safely re-circulated back into the laboratory environment if the cabinet is tested and certified at least annually and operated according to manufacturer’s recommendations. BSCs can also be connected to the laboratory exhaust system by either a thimble (canopy) connection or a direct (hard) connection.				
BMBL: D10	Provisions to assure proper safety cabinet performance and air system operation must be verified.				

Reference	Statement	Response			Comments
		Yes	No	N/A	
D	Laboratory Facilities (Secondary Barriers)				
BMBL: D10	BSCs should be certified at least annually to assure correct performance.				
BMBL: D10	Class III BSCs must be directly (hard) connected up through the second exhaust HEPA filter of the cabinet. Supply air must be provided in such a manner that prevents positive pressurization of the cabinet.				
BMBL: D11	A method for decontaminating all laboratory wastes should be available in the facility, preferably within the laboratory (e.g., autoclave, chemical disinfection, incineration, or other validated decontamination method).				
BMBL: D12	Equipment that may produce infectious aerosols must be contained in primary barrier devices that exhaust air through HEPA filtration or other equivalent technology before being discharged into the laboratory. These HEPA filters should be tested and/or replaced at least annually.				
BMBL: D13	Facility design consideration should be given to means of decontaminating large pieces of equipment before removal from the laboratory.				
BMBL: D14	Enhanced environmental and personal protection may be required by the agent summary statement, risk assessment, or applicable local, state, or federal regulations. These laboratory enhancements may include, for example, one or more of the following; an anteroom for clean storage of equipment and supplies with dress-in, shower-out capabilities; gas tight dampers to facilitate laboratory isolation; final HEPA filtration of the laboratory exhaust air; laboratory effluent decontamination; and advanced access control devices such as biometrics.				

Reference	Statement	Response			Comments
		Yes	No	N/A	
D	Laboratory Facilities (Secondary Barriers)				
BMBL: D15	The BSL-3 facility design, operational parameters, and procedures must be verified and documented prior to operation.				
BMBL: D15	Facilities must be re-verified and documented at least annually.				

Inspector Summary and Comments:

Recommendations:

Inspector Completing Checklist: _____ Date: _____

Other Inspectors Present: _____ Date: _____

--

--

--

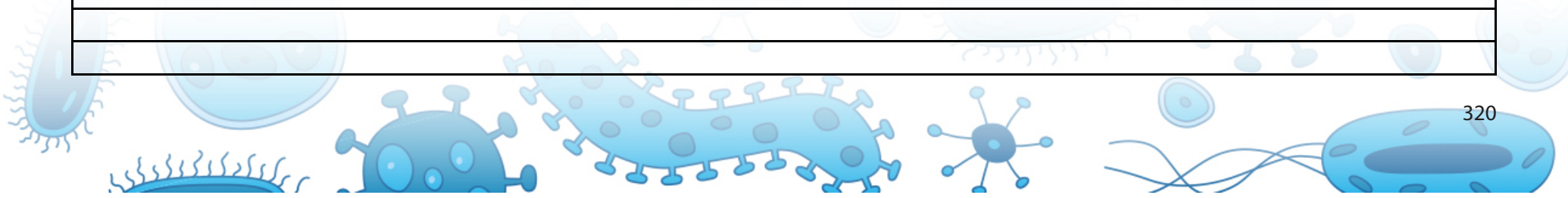

Procedure/Process: _____

PRINCIPAL STEPS (Procedure)	POTENTIAL SAFETY OR HEALTH HAZARD(S) (Pathogen) e.g., Agent, Chemical, Physical	SAFETY EQUIPMENT/Engineering Controls (Place) e.g., BSC	ADMINISTRATIVE CONTROLS AND WORK PRACTICES (Personnel) e.g., Training Requirements	RECOMMENDED PPE



Procedure/Process: Catalase Test and Hematology Differential Examples

PRINCIPAL STEPS (Procedure)	POTENTIAL SAFETY OR HEALTH HAZARD(S) (Pathogen) e.g., Agent, Chemical, Physical	SAFETY EQUIPMENT/Engineering Controls (Place) e.g., BSC	ADMINISTRATIVE CONTROLS AND WORK PRACTICES (Personnel) e.g., Training Requirements	RECOMMENDED PPE
<p>Catalase Test</p> <ol style="list-style-type: none"> 1. Touch colony of organism with stick or plastic loop 2. Put on slide 3. Add Hydrogen Peroxide 4. Observe for bubbles 	<p>Pathogen (?) Aerosol generation Chemicals Sharps</p>	<p>Perform this test in a tube, BSC, or use other engineering controls. Appropriate disinfectant Sharps containers</p>	<p>BSC usage; sharps handling; aerosol containment; pipette handling technique; chemical handling; SOP use and competency</p>	<p>Gloves Lab coat Face shield (optional if using a bench shield or BSC)</p>
<p>Hematology Differential</p> <ol style="list-style-type: none"> 1. Label slide 2. Pop open tube 3. Place drop of blood on slide 4. Swipe to make diff 5. Air dry 6. Stain 	<p>Sharps Aerosol generation Auto-inoculation Spill Chemicals</p>	<p>Use automated system, splatter shields, absorbent pads, tube holders Appropriate disinfectant Sharps containers.</p>	<p>SOP use and competency; sharps handling; aerosol containment; pipette handling technique: chemical handling</p>	<p>Gloves Lab coat Face shield (optional if using a bench shield or automated system)</p>



Document can be found here:

http://www.aphl.org/AboutAPHL/publications/Documents/ID_BiosafetyChecklist_42015.pdf

A Biosafety Checklist: Developing A Culture of Biosafety



Background

There is an inherent risk in a laboratory handling any infectious agents. Biosafety practices should be adhered to in all laboratories that receive potentially infectious material in order to ensure laboratory personnel, public and environmental safety. Recent incidents involving biosafety lapses highlight the need to enhance the culture of biosafety across the laboratory community in the United States. The Association of Public Health Laboratories (APHL) has developed *A Biosafety Checklist: Developing A Culture of Biosafety* to serve as a starting point for laboratories to assess the biosafety measures that they have in place.

Intended Use

A Biosafety Checklist: Developing A Culture of Biosafety is intended for any laboratory performing testing on infectious agents or clinical specimens that could contain infectious agents in the United States. It is designed to provide laboratories with the broad recommendations for components that should be considered for inclusion in any laboratory's biosafety policy. The checklist consists of six sections:

1. Risk Assessment
2. Selection of Safety Practices
 - Biosafety Level
 - Engineering Controls
 - Personal Protective Equipment (PPE)
 - Laboratory Practices
3. Biosafety Competencies
4. Safety Orientation and Training
5. Audits, Monitoring and Safety Committee
6. Administrative Controls

This checklist is for your laboratory's internal use only. The questions in this checklist are included to guide biosafety discussion within your laboratory and do not address biosecurity practices. Some questions may not be applicable to every laboratory and some laboratories may want to add additional questions to perform their risk assessments. This tool can be modified to meet your laboratory's needs as necessary and information gained from this tool can be used to help laboratories identify areas for improvement in their biosafety practices.

TRANSPORTING INFECTIOUS SUBSTANCES SAFELY

Document can be found here:

https://hazmatonline.phmsa.dot.gov/services/publication_documents/Transporting%20Infectious%20Substances%20Safely.pdf

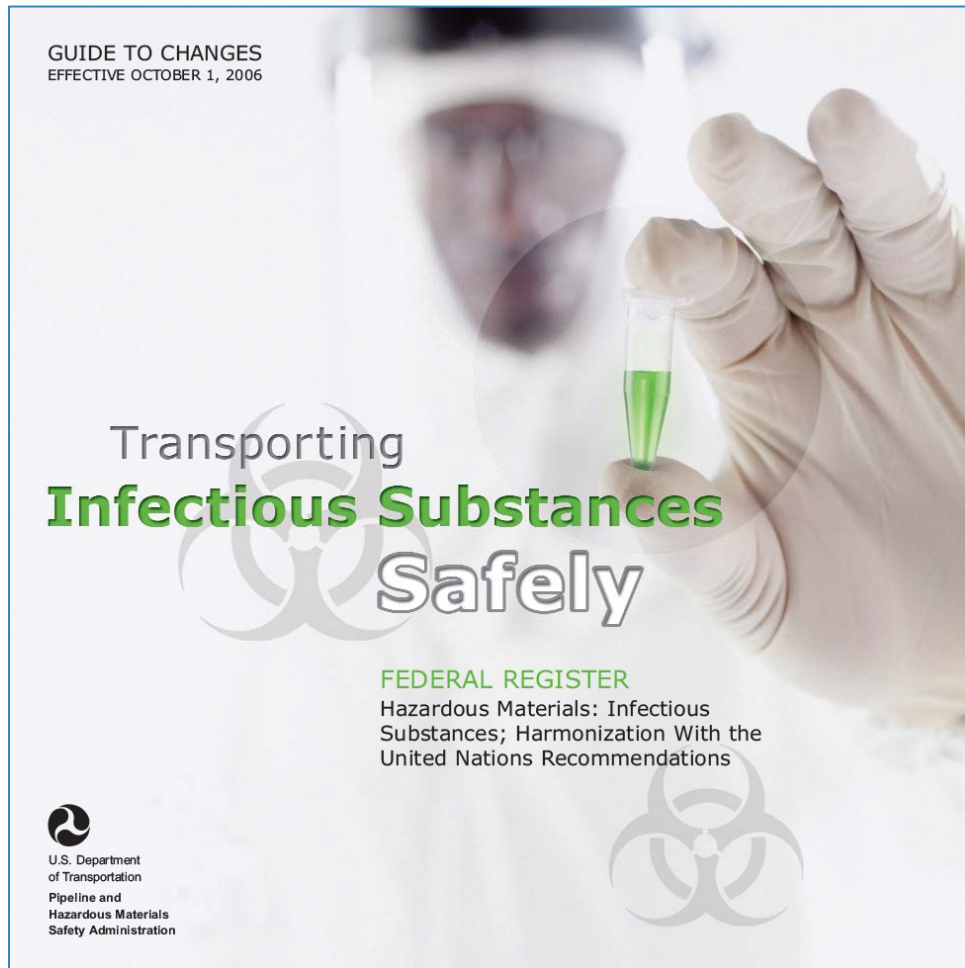

SENTINEL LABORATORY BIOCHEMICAL REFERENCE CHART

Catalase Test

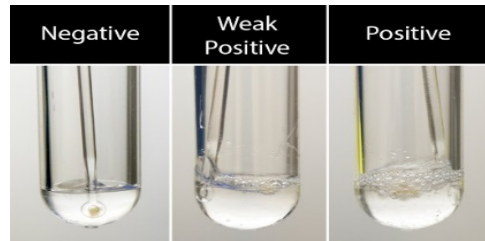

3% Hydrogen peroxide: Look for bubbles.

Safety Warning: To contain potential aerosols perform in a BSC, covered petri dish or tube.

Negative Control: *S. pyogenes* ATCC® 19615

Positive Control: *S. aureus* ATCC® 33592/25923

Motility

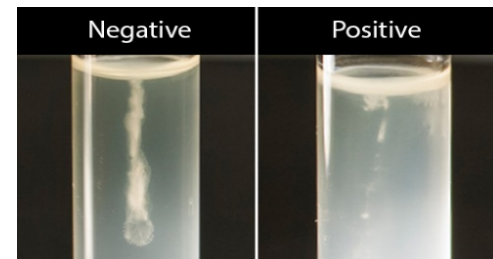

Compare the uninoculated tube with the inoculated tube

Negative: See only growth in the line of inoculum (no fuzziness or spreading and media is clear).

Intermediate: Just starting to see growth out from the line of inoculum (fuzzy) but media is still clear.

Positive: See distinct growth out from line of inoculum into the media (not clear).

Negative Control:

K. pneumoniae ATCC® 13883/27736

Positive Control: *E. coli* ATCC® 25922

Spot Indole Test



Cinnamaldehyde reagent: Look for blue color.

Negative Control: *E. coli* ATCC® 25922

Positive Control: *P. aeruginosa* ATCC® 27853

Arginine Decarboxylase

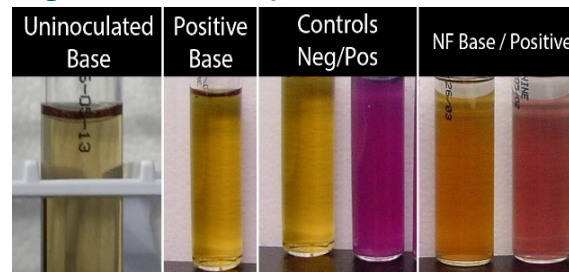

Compare the uninoculated Base with the inoculated Base and Arginine tubes to determine color changes.

1st Step - Base only (no Arginine): Look for color change inoculated base to yellow, golden or grey yellow (see NF Base) to indicate that the organism utilized the glucose and pH decreased.

2nd Step - Arginine: Look for color change in inoculated base and arginine back to purple indicating decarboxylation of Arginine occurred and pH increased.

Negative Control - Arginine tube yellow indicating no decarboxylation: *E. coli* ATCC® 25922

Positive Control - Arginine tube purple indicating decarboxylation: *P. aeruginosa* ATCC® 27853

Non-Fermenters that are Arginine positive (suspect *Burkholderia* spp.): Color change is more subtle.

Base is golden or grey yellow and Arginine tube maybe lighter shade of purple.

Oxidase Test

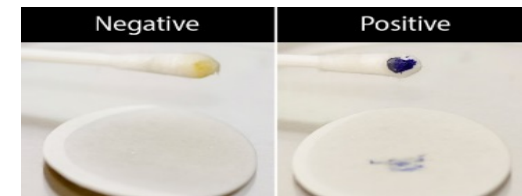

Tetramethyl reagent: Look for purple color.

Negative Control: *E. coli* ATCC® 25922

Positive Control: *P. aeruginosa* ATCC® 27853

Motility with TTC

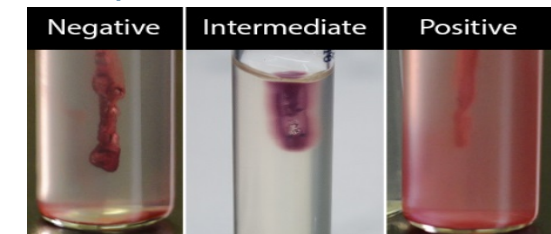

Triphenyltetrazolium chloride (TTC): A colorless dye in the medium that turns red when bacteria reduce it.

Warning: TTC inhibits some bacteria.

Look for evidence of spreading of growth away from the line of inoculum.

Negative: See only the red in the line of inoculum (no fuzziness or spreading and media is clear).

Intermediate: Just starting to see growth out from the line of inoculum (fuzzy) but media is still clear.

Positive: See distinct growth out from line of inoculum into the media (not clear).

Negative Control:

K. pneumoniae ATCC® 13883/27736

Positive Control: *E. coli* ATCC® 25922



TESTS TO DIFFERENTIATE ORGANISMS SIMILAR TO THE BIOTERRORISM AGENTS

Possible Misidentifications for <i>Bacillus anthracis</i> Include:	
Organism	Differential Test
<i>Bacillus megaterium</i>	Motility Positive (Note: 16% are non-motile)
<i>Bacillus subtilis</i>	Motility Positive
<i>Bacillus cereus</i>	Hemolytic
<i>Bacillus thuringiensis</i>	Hemolytic and not a human pathogen

Possible Misidentifications for <i>Brucella</i> Include:	
Organism	Differential Test
<i>Haemophilus species</i> Also will appear as tiny coccobacillus in Gram stain.	Catalase, urease and oxidase variable Will not grow on blood agar. Will demonstrate satellite growth around <i>S. aureus</i> on blood agar while <i>Brucella</i> growth is present on blood agar, and is not limited to the area around the <i>Staphylococcus</i> .
<i>Oligella ureolytica</i> Also will appear as tiny coccobacillus in Gram stain, usually found only in the urine. Both this organism and <i>Brucella</i> are catalase, urease and oxidase positive.	<i>O. ureolytica</i> will show delayed motility. Note: Since <i>Oligella</i> has poor motility reaction, it would be better ruled-out with PDA (<i>Oligella</i> is PDA positive and <i>Brucella</i> is PDA negative) which is included in some rapid urea tests. Motility is also not necessary since <i>O. ureolytica</i> is rarely found in the blood or sterile sites where <i>Brucella</i> is more likely to be found. <i>O. ureolytica</i> is a rare urinary pathogen.
<i>Psychrobacter phenylpyruvicus</i> Both this organism and <i>Brucella</i> are catalase, urease and oxidase positive.	<i>Psychrobacter phenylpyruvicus</i> has plump (not tiny) rods or coccobacillus and is PDA positive.
<i>Psychrobacter immobilis</i> Both this organism and <i>Brucella</i> are catalase, urease and oxidase positive.	<i>P. immobilis</i> will prefer to grow at 25°C. May have an odor of roses (however, do NOT sniff cultures). Variable growth on MAC.
<i>Bordetella bronchiseptica</i> Both this organism and <i>Brucella</i> are catalase, urease and oxidase positive.	<i>Bordetella bronchiseptica</i> is motile, and <i>Brucella</i> is nonmotile. Note: Motility testing is not needed to rule-out <i>Bordetella</i> since <i>B. bronchiseptica</i> grows on MAC, and is a rarely encountered organism in sterile site specimens.
<i>Paracoccus yeei</i> Both this organism and <i>Brucella</i> are catalase, urease and oxidase positive.	<i>P. yeei</i> will appear mucoid on BAP.

Possible Misidentifications for <i>Burkholderia mallei</i> Include:	
Organism	Differential Test
<i>Burkholderia cepacia</i>	Resistant to amoxicillin-clavulanic acid, lactose fermenter (LF) on MacConkey and EMB, motile, arginine negative.
<i>Chromobacterium violaceum</i>	Hemolysis, violet pigment on BAP, motile
<i>Pseudomonas stutzeri</i>	Growth on MacConkey, arginine negative
<i>Stenotrophomonas maltophilia</i>	Growth on MacConkey, arginine negative
<i>Bacillus</i> spp. may appear Gram negative	Sensitive to penicillin
<i>Pandoraea</i> spp.	Growth on MacConkey
<i>Ralstonia</i> spp.	Growth on MacConkey

Possible Misidentifications for <i>Burkholderia pseudomallei</i> Include:	
Organism	Differential Test
<i>Burkholderia cepacia</i>	Resistant to amoxicillin-clavulanic acid, lactose fermenter (LF) on MacConkey and EMB, arginine negative.
<i>Chromobacterium violaceum</i>	Hemolysis, violet pigment on BAP
<i>Pseudomonas aeruginosa</i>	Colonial morphology, grape odor (do NOT sniff plates)
<i>Pseudomonas stutzeri</i>	Arginine negative, susceptible to polymyxin B
<i>Stenotrophomonas maltophilia</i>	Arginine negative

Possible Misidentifications for <i>Francisella tularensis</i> include:	
Organism	Differential Test
<i>Acinetobacter</i> spp.	MAC positive, oxidase positive
<i>Aggregatibacter</i> spp.	Catalase, positive β -lactamase, negative
<i>Haemophilus</i> spp.	Oxidase positive, requires X & V factors
<i>Haemophilus influenzae</i>	Satellite or XV positive
<i>Bordetella</i> Grp. IV	Inert, urea positive
<i>Pasturella</i> spp	Non-sticky, MAC positive
<i>Dysgonomonas</i> spp.	Colonies measure 1 to 2 mm in diameter after 24 h of growth, have a distinct strawberry-like odor (do NOT sniff plates).
<i>Brucella</i> spp.	Oxidase, urea and catalase positive
<i>Psychrobacter phenylpyruvicus</i>	Oxidase positive
<i>Oligella ureolytica</i>	Oxidase positive



Possible Misidentifications for <i>Yersinia pestis</i> Include:	
Organism	Differential Tests
<i>Acinetobacter</i> spp.	May appear as gram-negative coccobacilli, often in pairs. Glucose non-fermenter. Colony morphology
<i>Escherichia. coli</i> , lactose-negative	Faster growth rate Indole positive (80%) Colony morphology
<i>Pantoea</i> (formerly <i>Enterobacter</i>) <i>agglomerans</i>	Faster growth rate May produce yellow pigment ONPG positive (90%)
<i>Pasteurella multocida</i>	Faster growth rate Oxidase positive (may be weak) Indole positive Colony morphology, may appear mucoid
<i>Pseudomonas luteola</i>	May produce yellow pigment Glucose non-fermenter
<i>Pseudomonas</i> spp.	Oxidase positive (except <i>P. luteola</i> & <i>P. oryzihabitans</i>) Glucose non-fermenter
<i>Shigella</i> spp.	Faster growth rate Colony morphology Shigella antisera
<i>Salmonella</i> spp., H ₂ S-negative	Faster growth rate Colony morphology Salmonella antisera
<i>Yersinia enterocolitica</i>	Small gram-negative coccobacilli Urease positive* Indole variable
<i>Yersinia pseudotuberculosis</i>	Urease positive*

* *Y. pseudotuberculosis* and *Y. enterocolitica* give stronger reactions in urea agar or broth when incubated at 25-28°C, but incubation at this temperature is not necessary to demonstrate urease production.

ACKNOWLEDGEMENTS

CLINICAL LABORATORY PREPAREDNESS GUIDE REVISION WORKGROUP MEMBERS

Project Leads: Shoolah Escott, MS, Massachusetts State Public Health Laboratory, Department of Public Health, Jamaica Plain, MA, (Former) Laboratory Training Team, CDC, Atlanta, Georgia; James Rudrik, PhD, Infectious Disease Division, Michigan Department of Health and Human Services, Lansing, Michigan; Amy Pullman, MPH, MT, Specialist, Public Health Preparedness and Response Program, Association of Public Health Laboratories, Silver Spring, Maryland; Robert Nickla, Oregon Health Authority, State Public Health Laboratory, Hillsboro, Oregon.

Facilitator: Judy Delany, MS, MPH, former consultant, Association of Public Health Laboratories, Silver Spring, Maryland

Content Team Leads: Crystal Fortune, Montana Department of Public Health and Human Services, Laboratory Services Bureau, Helena, Montana; Robert Nickla, Oregon Health Authority, State Public Health Laboratory, Hillsboro, Oregon; Wanda Reiter-Kintz, State Hygienic Laboratory, University of Iowa, Coralville, Iowa; Lisa Wallace, West Virginia Department of Health and Human Resources, Bureau of Public Health, Office of Laboratory Services, Charleston, West Virginia.

Content Team Members: Carrol Akanegbu, District of Columbia, Department of Forensic Sciences, Public Health Laboratory, District of Columbia; Rick Danforth, Maine Department of Health and Human Services, Division of Public Health Systems, Health and Environmental Testing Laboratory, Augusta, Maine; Heather Matthies, Arizona Department of Health Services, Bureau of State Laboratory Services, Phoenix, Arizona; Shelley Matheson, Indiana State Department of Health Laboratory, Indianapolis, Indiana; Amanda Moore, South Carolina Department of Health and Environmental Control, Bureau of Laboratories, Columbia, South Carolina; Pamela Morden, New Mexico Department of Health, Scientific Laboratory Division, Albuquerque, New Mexico; Karen Stiles, Department of Health and Human Services, University of Nebraska Medical Center, Nebraska Public Health Laboratory, Omaha, Nebraska; Vickie Whitaker, consultant, Association of Public Health Laboratories, Silver Spring, Maryland; Sue Riley, consultant, Association of Public Health Laboratories, Silver Spring, Maryland.

Reviewers: Elizabeth Weirich, Center for Surveillance, Epidemiology, and Laboratory Services, Division of Laboratory Services, CDC, Atlanta, Georgia; Patricia Payne, Consultant, Association of Public Health Laboratories, Silver Spring, Maryland; Chris Mangal, Association of Public Health Laboratories, Silver Spring, Maryland; Amy Pullman, Association of Public Health Laboratories, Silver Spring, Maryland; Cheryl Gauthier, Massachusetts Department of Public Health, Bureau of Laboratory Sciences, Jamaica Plain, Massachusetts; James Rudrik, PhD, Infectious Disease Division, Michigan Department of Health and Human Services, Lansing, Michigan; Kristi Jenkins, North Carolina State Laboratory of Public Health, Raleigh, North Carolina; Erin Bowles, Wisconsin State Laboratory of Hygiene, Madison, Wisconsin; Crystal Barrett, Virginia Division of Consolidated Laboratory Services, Richmond, Virginia; Anna Gibson, TIEHH Bioterrorism Response Laboratory, Texas Tech University and Health Sciences Center, Lubbock Texas; James Snyder, PhD, Affiliated with ASM, University of

Louisville, Louisville, Kentucky. Rebecca Sciulli, Hawaii State Laboratories Division, Pearl City, Hawaii; Steven D. Mahlen, PhD, Microbiology Division, Affiliated Laboratory, Inc., Bangor, Maine.

Design and Graphics Members (if not mentioned previously): Joseph Rothschild, Laboratory Training Team, CDC, Atlanta, Georgia, Kevin Clark, Laboratory Training Team, CDC, Atlanta, Georgia, Betty Wheeler, Florida Bureau of Public Health Laboratories, Jacksonville, Florida; Karen Mulawski, former consultant, Association of Public Health Laboratories, Silver Spring, Maryland; Janette Case, Unified State Laboratories, Taylorsville, Utah; Christopher Chadwick, former, Association of Public Health Laboratories, Silver Spring, Maryland; Erin Swaney, Texas Department of State Health Services, Austin, Texas; Syra Madad, Texas Department of State Health Services; Austin, Texas; Janis Thompson, Public Health Laboratory, Little Rock, Arkansas.

Photographs: Arizona Department of Health Services, Bureau of State Laboratory Services, Phoenix, Arizona; FedEx Corporation; Massachusetts Department of Public Health, Bureau of Laboratory Sciences, William A. Hinton State Laboratory Institute, Jamaica Plain, Massachusetts; Infectious Disease Section, Minnesota Department of Health, Public Health Laboratory, St. Paul, Minnesota; Department of Health and Human Services, University of Nebraska Medical Center, Nebraska Public Health Laboratory, Omaha, Nebraska; New Mexico Department of Health, Scientific Laboratory Division, Albuquerque, New Mexico; Oregon Health Authority, State Public Health Laboratory, Hillsboro, Oregon

DISCLAIMER

This publication (brief, report, article, etc.) was supported by Cooperative Agreement # U60OE000103 funded by the Centers for Disease Control and Prevention. Its contents are solely the responsibility of the authors and do not necessarily represent the official views of CDC or the Department of Health and Human Services. This project is funded 100% by Federal funds.

